

UG-25NA, -25NSA DIE GRINDERS

EXPLODED VIEW

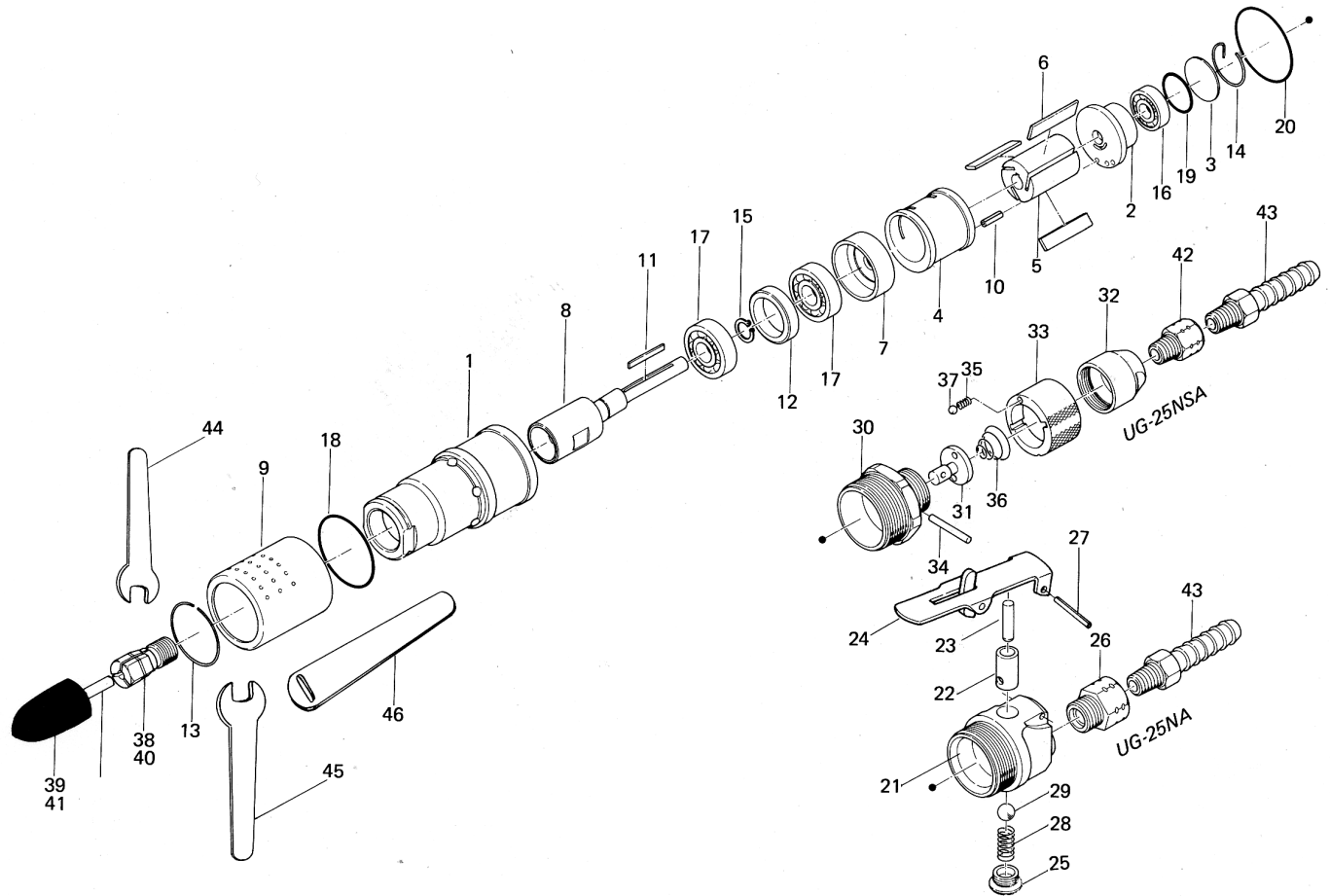

PARTS LIST — FOR REFERENCE ONLY

Index Number	Part Number	Description	Qty.	Index Number	Part Number	Description	Qty.	Index Number	Part Number	Description	Qty.	
1	500-025-6	Casing	1	500-983-6 HANDLE ASSEMBLY COMPONENTS FOR UG-25NA				37	981-002-0	Ball (1/8)	1	
2	500-285-2	Rear Plate	1	21	500-014-1	Handle Body	1	42	942-114-0	Connecting Screw (1/4 x NPT1/4)	1	
3	505-291-1	Rear Plate Spacer	1	22	500-102-2	Valve Bushing	1	ACCESSORIES				
4	500-286-1	Cylinder	1	23	970-319-0	Pin (H) (4 x 19)	1	44	936-514-0	Spanner (14)	1	
5	500-287-1	Rotor	1	24	500-914-7	Self-Locking Valve Lever Assembly	1	45	936-517-0	Spanner (17)	1	
6	500-288-1	Blade	3 ●	25	201-108-1	Valve Plug	1	46	939-101-0	Spanner (5.5 x 17.5 x 120)	1	
7	500-289-1	Front Plate	1	26	418-091-1	Air Inlet Bushing	1	38	923-003-0	Collet Chuck (6 mm)	1	
8	500-390-1	Wheel Spindle	1	27	973-124-0	Roll Pin (3 x 24)	1	40	923-006-0	Collet Chuck (1/4)	1	
9	500-782-6	Exhaust Deflector	1	28	976-151-0	Spring (7 x 16) (0.7)	1					
10	973-110-0	Roll Pin (3 x 10)	1	29	981-208-0	Ball (5/16) Black	1					
11	974-700-0	Key (1.4 x 2.3 x 20)	1	501-003-2 HANDLE ASSEMBLY COMPONENTS FOR UG-25NSA								
12	975-189-0	Spacer (26 x 20 x 6)	1	30	501-014-2	Handle Body	1					
13	978-321-0	Snap Ring (32 x 1.8)	1	31	506-100-2	Valve	1					
14	978-219-0	Snap Ring (22 x 1.2)	1	32	506-090-2	Air Inlet Bushing	1					
15	979-107-0	Outer Snap Ring (10)	1 ●	33	506-015-2	Valve Handle	1					
16	982-021-0	Ball Bearing (626)	1 ●	34	971-224-0	Pin (3 x 24)	1					
17	982-100-0	Ball Bearing (6000)	2 ●	35	976-022-0	Spring (3 x 5.5) (0.4)	1					
18	990-919-0	O-Ring (SNS 22)	1	36	977-080-0	Cone Spring (7 x 18 x 10)	1					
19	990-914-0	O-Ring (SNS 16)	1 ●									
20	990-925-0	O-Ring (SNS 32)	1 ●									



10000 SE PINE
PORTLAND, OR 97216
503-254-6600
FAX 503-255-2615

When ordering spare parts, please specify tool type, part number, and description.

FOOTNOTES

● = Items in Pulse Repair Kit UG-25N-RK

UG-25N-RK

(Kit contains following parts)

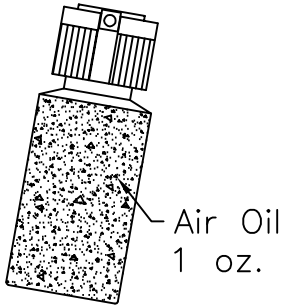
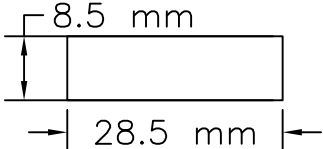
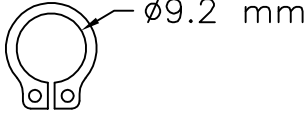
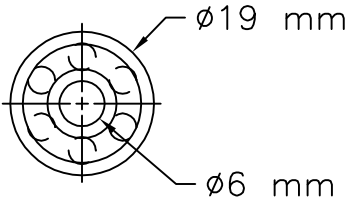
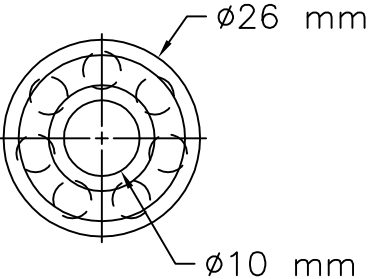
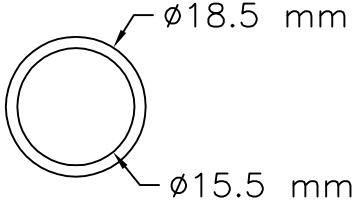
#/#	Bin Location	Part Number	QTY	Description	Material	Drawing / Scketch
1	SEWALL	AM-OIL	1	Oil Air Motor 1 oz. fluid	Plastic Container	
2	PA1J2	500-288-1	3	Blade 8.5x28.5x1.65	Phenolic-Fiber	
3	PA4K	979-107-0	1	Outer Snap Ring ø.362 (10)	Steel	
4	PA2H	982-021-0	1	Ball Bearing(626) 6x19x6	Bearing Steel	
5	PA2H	982-100-0	1	Ball Bearing(6000) 10x26x8	Bearing Steel	
6	PA1B	990-914-0	1	O-Ring (SNS-29) 15.5x18.5x1.5	Buna-Black	

UG-25N-RK

(Kit contains following parts)

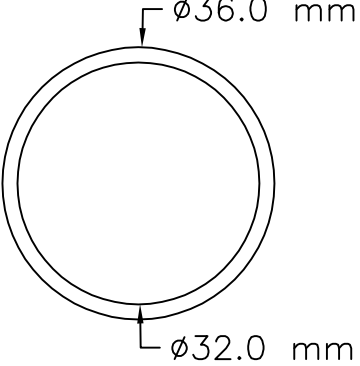
#/#	Bin Location	Part Number	QTY	Description	Material	Drawing / Scketch
7	PA1B	990-925-0	1	O-Ring (SNS-32) 32x36x2	Buna-Black	 <p style="text-align: right;"> $\phi 36.0$ mm $\phi 32.0$ mm </p>