

# UX-1400 OIL-PULSE TOOLS

## EXPLODED VIEW

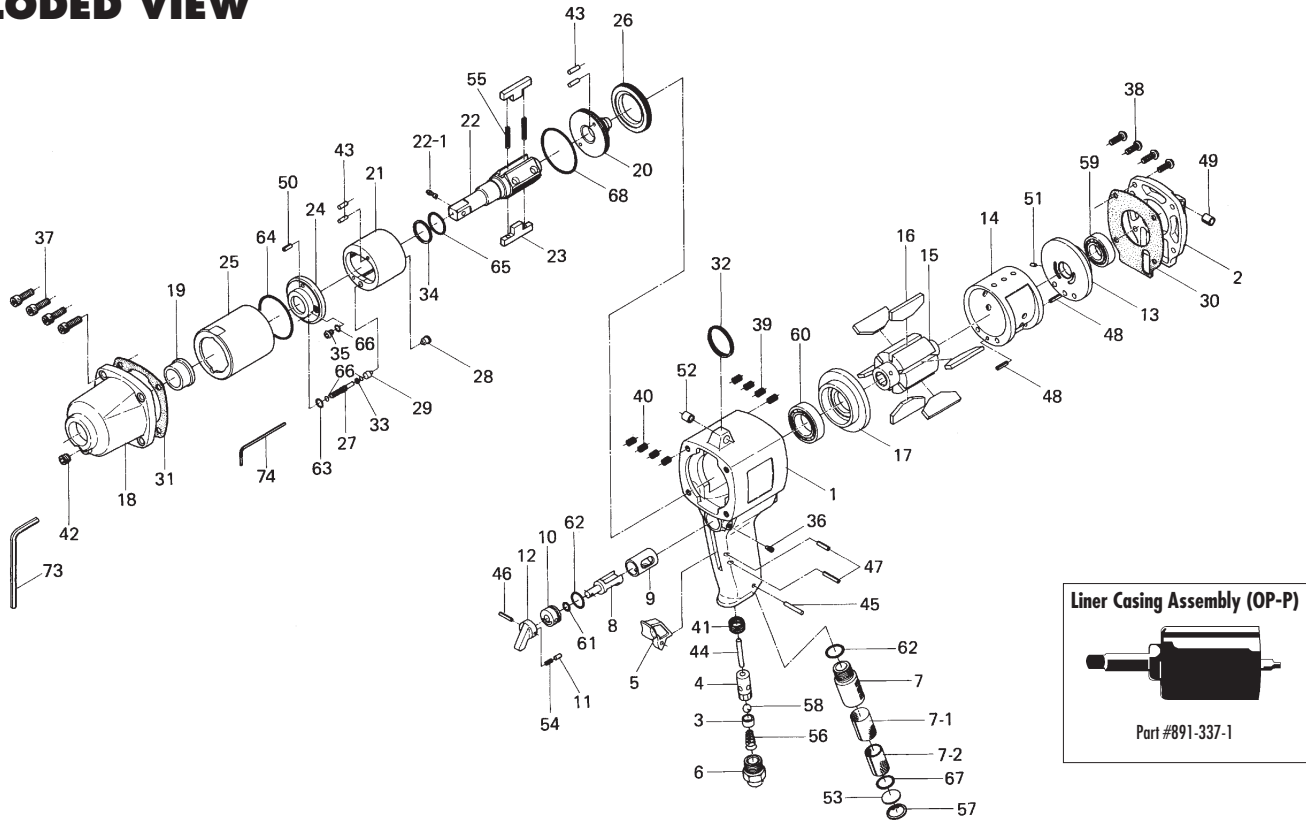

## PARTS LIST — FOR REFERENCE ONLY

Index Number	Part Number	Description	Qty.	Index Number	Part Number	Description	Qty.	Index Number	Part Number	Description	Qty.
1	195-025-3	Handle	1	25	195-905-3	Liner Casing	1	48	973-214-0	Roll Pin (4 x 14)	2
2	195-012-3	Head Cover	1	26	195-906-3	Liner Casing Setter	1	49	973-360-0	Roll Pin (8 x 10)	1
3	188-100-1	Valve	1	27	195-907-3	Relief Valve Spindle	1	50	969-450-0	Pin (G) (3 x 8)	1
4	063-102-3	Valve Bushing	1	28	195-969-3	Relief Valve Plug	1	51	973-066-0	Roll Pin (2.5 x 6)	1
5	026-107-7	Valve Lever	1	29	195-970-3	Relief Valve	1	52	973-361-0	Roll Pin (8 x 12)	1
6	195-091-3	Air Inlet Bushing	1	30	195-853-3	Head Cover Packing	1	53	975-600-0	Spacer (20 x 1)	1
7	195-780-9	Exhaust Stack	1	31	195-867-3	Front Casing Packing	1	54	976-025-0	Spring (3 x 8.5)	1
7-1	195-042-9	Silencer	1	32	004-790-2	Suspension Ring	1	55	976-795-0	Spring (4.3 x 40.5) (0.6) WPC	2 ●
7-2	195-835-4	Filter	1	33	944-003-0	Supporter Ring (3 x 5 x 1)	2 ●	56	977-180-0	Cone Spring (7.5 x 12 x 22)	1
8	189-210-8	Reverse Valve	1	34	944-221-0	Supporter Ring (20.9 x 24.72 x 1.25)	1 ●	57	979-320-0	Inner Snap Ring (IRTW-20)	1
9	189-211-8	Reverse Valve Bushing	1	35	945-942-0	Hexagon Round Head Bolt (M4 x 6)	1	58	981-208-0	Ball (5/16)	1
10	187-222-1	Reverse Valve Setter	1	36	952-108-0	Allen Head Dog Point Screw (M4 x 8)	1	59	982-103-0	Ball Bearing (6003)	1
11	054-220-1	Reverse Lever Notch	1	37	945-220-0	Allen Head Bolt (M6 x 20)	4	60	982-906-0	Ball Bearing (6905)	1
12	023-212-4	Reverse Lever	1	38	945-954-0	Hexagon Round Head Bolt (M5 x 16)	4	61	990-205-0	O-Ring (JW1516-5)	1
13	189-285-4	Rear Plate	1	39	965-011-0	Heli-Sert (M5 x 1.5D)	4	62	990-914-0	O-Ring (SNS-16)	2
14	189-286-4	Cylinder	1	40	965-021-0	Heli-Sert (M6 x 1.5D)	4	63	990-974-0	O-Ring (SNS-6) (NOK)	1 ●
15	189-287-8	Rotor	1	41	965-118-0	Heli-Sert (M18 x 1.5 x 1D)	1	64	990-937-0	O-Ring (SNS-46)	1 ●
16	189-288-9	Blade	6	42	966-100-0	Allen Head Plug (1/8)	1	65	990-160-0	O-Ring (P-21) (NTN)	1 ●
17	189-289-4	Front Plate	1	43	970-206-0	Pin (H) (3 x 8)	4	66	990-971-0	O-Ring (SNS-3) (NOK)	3 ●
18	195-439-3	Front Casing	1	44	970-337-0	Pin (H) (4 x 36)	1	67	990-916-0	O-Ring (SNS-18)	1
19	195-328-3	Anvil Bushing	1	45	971-163-0	Pin (2.5 x 23)	1	68	990-936-0	O-Ring (SNS-45)	1 ●
20	195-901-3	Rear Liner Plate	1	46	973-016-0	Roll Pin (2 x 16)	1				
21	195-902-3	Liner	1	47	973-118-0	Roll Pin (3 x 24)	2				
22	891-314-1	Anvil (OP-P)	1								
22-1	891-304-1	Socket Retainer Pin Assembly	1								
23	195-440-3	Driving Blade	2								
24	195-904-3	Front Liner Plate	1								

### ACCESSORIES

73	939-104-0	Allen Wrench (5 mm)	1
74	939-109-0	Allen Wrench (2 mm)	1

### FOOTNOTES

● = Items in Pulse Repair Kit UX-1400-PRK



10000 SE PINE  
PORTLAND, OR 97216  
503-254-6600  
FAX 503-255-2615

When ordering spare parts, please specify  
tool type, part number, and description.

# UX-1400-PRK

(Kit contains following parts)

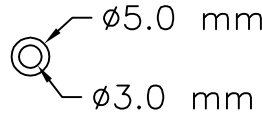
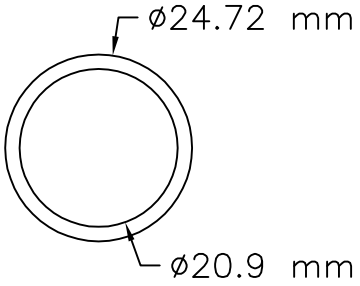
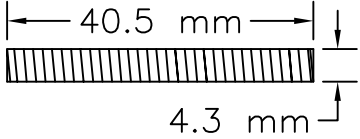
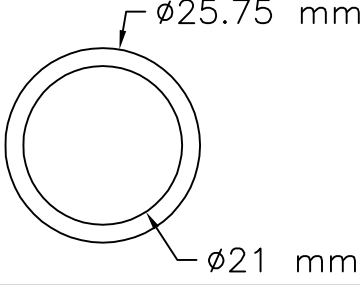
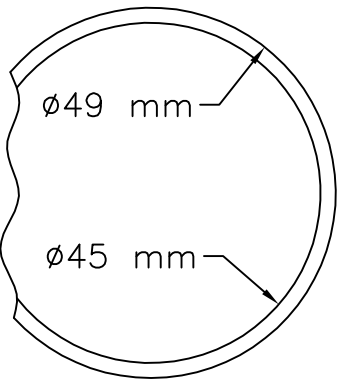
#/#	Bin Location	Part Number	QTY	Description	Material	Drawing / Scketch
1	PA10	944-003-0	2	Support Ring 3.0x5.0x1	Teflon-White	
2	PA10	944-221-0	1	Support Ring 20.9x24.72x1.25	Teflon-White	
3	PA1J	976-795-0	2	Spring 4.3x40.5 (0.6) WPC	Spring wire ø.60 mm	
4	PA1A	990-160-0	1	O-Ring (P21) (NTN) 21x25.75x2.5	Buna-Black	
5	PA1B	990-936-0	1	O-Ring (SNS-45) 45x49x2	Buna-Black	

# UX-1400-PRK

(Kit contains following parts)

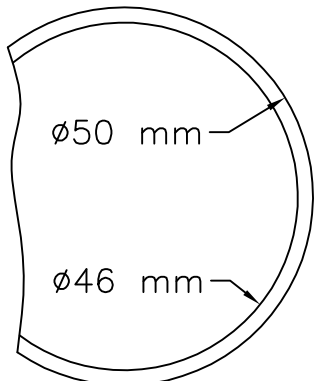
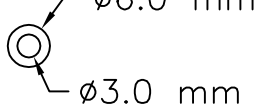
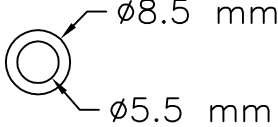
#/#	Bin Location	Part Number	QTY	Description	Material	Drawing / Scketch
6	PA1B	990-937-0	1	O-Ring (SNS-46) 46x50x2	Buna-Black	 <p> <math>\phi 50</math> mm  <math>\phi 46</math> mm         </p>
7	PA1C	990-971-0	3	O-Ring (SNS-3) (NOK)	Buna-Black	 <p> <math>\phi 6.0</math> mm  <math>\phi 3.0</math> mm         </p>
8	PA1C	990-974-0	1	O-Ring (SNS-6) (NOK)	Buna-Black	 <p> <math>\phi 8.5</math> mm  <math>\phi 5.5</math> mm         </p>