

UX-800, ST800 OIL-PULSE TOOLS

EXPLODED VIEW

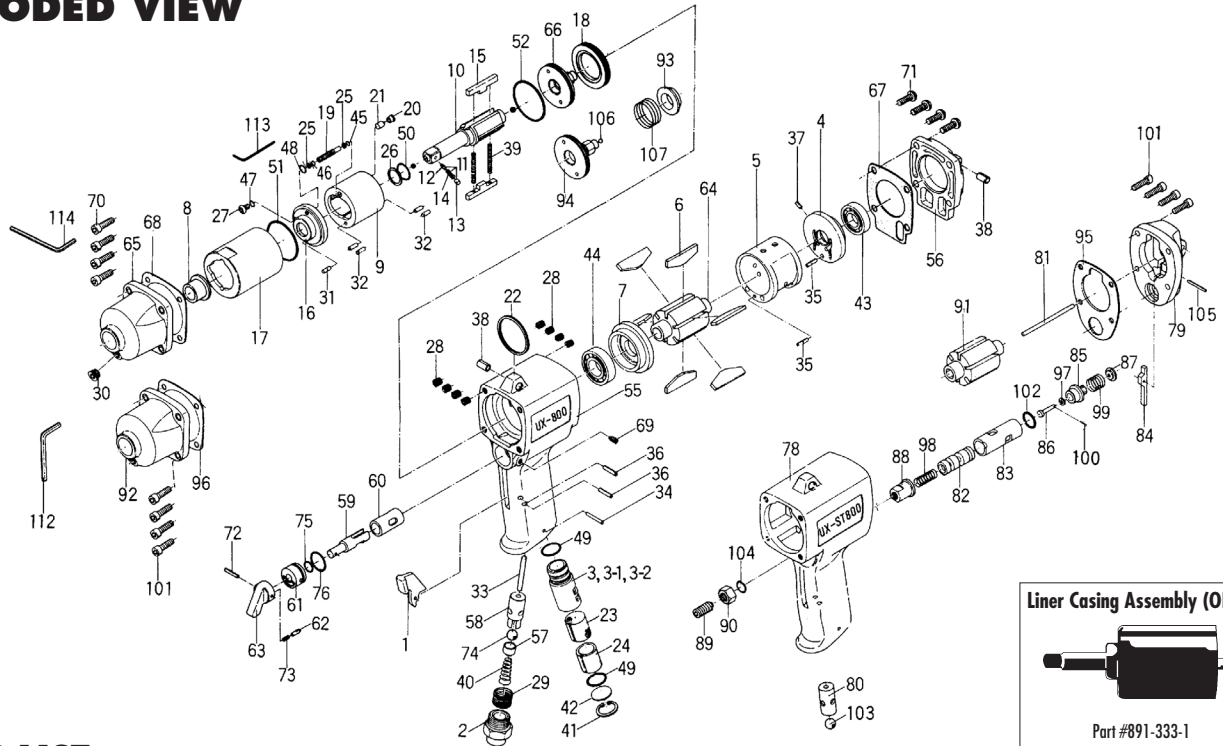

PARTS LIST — FOR REFERENCE ONLY

Index Number	Part Number	Description	Qty.	Index Number	Part Number	Description	Qty.	Index Number	Part Number	Description	Qty.
1	187-107-1	Valve Lever	1	38	973-340-0	Roll Pin (6 x 10)	2	76	990-914-0	O-Ring (SNS-16)	1
2	185-091-7	Air Inlet Bushing	1	39	976-800-0	Spring (3.7 x 30) (0.5) WPC	2	PARTS FOR UX-ST800			
3	194-780-4	Exhaust Stack	1	40	977-175-0	Cone Spring (7.5 x 10.3 x 22)	1	78	183-025-2	Handle	1
3-1	194-781-2	Exhaust Stack Bushing	1	41	979-318-0	Inner Snap Ring (IRTW18)	1	79	183-012-2	Head Cover	1
3-2	980-008-0	Round Head Notch (2.4)	1	42	975-598-0	Round Plate (18 x 1)	1	80	063-102-1	Valve Bushing	1
4	026-285-7	Rear Plate	1	43	982-403-0	Ball Bearing (EE-4)	1	81	183-130-2	Piston Rod	1
5	026-286-7	Cylinder	1	44	982-950-0	Ball Bearing (16002)	1	82	021-210-1	Reverse Valve	1
6	167-288-6	Blade (PC)	6	45	990-320-0	O-Ring (ARP568-003)	1	83	183-211-2	Reverse Valve Bushing	1
7	194-289-2	Front Plate	1	46	990-900-0	O-Ring (SNS-2)	1	84	021-212-1	Reverse Lever	1
8	185-328-2	Anvil Bushing	1	47	990-971-0	O-Ring (SNS-3)	1	85	021-225-1	Subsidiary Valve Body	1
9	194-902-2	Liner	1	48	990-973-0	O-Ring (SNS-5) (NOK)	1	86	021-226-1	Subsidiary Valve	1
10	891-310-1	Anvil (OP-P)	1	49	990-914-0	O-Ring (SNS-16)	2	87	021-227-1	Subsidiary Valve Spring Retainer	1
11	891-300-1	Socket Retainer Pin Assembly	1	50	992-020-0	O-Ring (Q12) (NTN)	1	88	021-255-1	Regulator Barrel	1
12	891-301-1	Socket Retainer Pin	1	51	990-337-0	O-Ring (JW1530-27)	1	89	183-256-2	Regulator Spindle	1
13	891-302-1	Bushing	1	52	990-924-0	O-Ring (SNS-30)	1	90	183-269-2	Regulator Spindle Nut	1
14	976-245-0	Spring (2.6 x 5.5 x 0.3)	1	PARTS FOR UX-800							
15	194-440-2	Driving Blade	2	55	194-025-2	Handle	1	91	183-287-2	Rotor	1
16	194-904-2	Front Liner plate	1	56	194-012-2	Handle Cover	1	92	183-439-2	Front Casing	1
17	194-905-2	Liner Casing	1	57	186-100-1	Valve	1	93	183-164-2	Spring Retainer	1
18	194-906-2	Liner Casing Cover	1	58	063-102-3	Valve Bushing	1	94	183-901-2	Liner Rear Plate	1
19	194-907-2	Relief Valve Spindle	1	59	187-210-1	Reverse Valve	1	95	183-853-2	Head Cover Packing	1
20	194-969-2	Relief Valve Plug	1	60	185-211-1	Reverse Valve Bushing	1	96	185-867-7	Front Casing Packing	1
21	194-970-2	Relief Valve	1	61	187-222-1	Reverse Valve Setter	1	97	975-077-0	Spacer (16.5 x 13 x 0.8)	1
22	004-790-2	Suspension Ring	1	62	054-220-1	Reverse Valve Notch	1	98	976-130-0	Spring (6.5 x 23 x 0.8)	1
23	194-042-4	Silencer	1	63	023-212-4	Reverse Lever	1	99	976-299-0	Spring (12 x 15 x 1.0)	1
24	611-780-4	Filter	1	64	194-287-2	Rotor	1	100	970-008-0	Pin (H) (1 x 5.8)	1
25	944-002-0	Supporter Ring (2.6 x 4.5 x 1)	2	65	194-439-2	Front Casing	1	101	945-012-0	Allen Head Bolt (M4 x 12)	8
26	944-213-0	Supporter Ring (12 x 15.9 x 1)	1	66	194-901-2	Rear Liner Plate	1	102	990-011-0	O-Ring (P12)	1
27	945-942-0	Hexagon Round Head Bolt (M4 x 6)	1	67	194-853-2	Head Cover Packing	1	103	981-210-0	Ball (Black) (3/8)	1
28	965-011-0	Heli-Sert (M5 x 1.5D)	8	68	194-867-2	Front Casing Packing	1	104	990-906-0	O-Ring (SNS-8)	1
29	965-073-0	Heli-Sert (UNF5/8 x N6)	1	69	952-108-0	Allen Head Dog Point Screw (M4 x 8)	1	105	970-225-0	Pin (H) (3 x 25)	1
30	966-100-0	Allen Head Plug (PT1/8)	1	70	945-117-0	Allen Head Bolt (M5 x 16)	4	ACCESSORIES			
31	969-450-0	Pin (G) (3 x 8)	1	71	945-955-0	Hexagon Round Head Bolt (M5 x 18)	4	106	981-002-0	Ball (1/8)	1
32	970-206-0	Pin (H) (3 x 8)	4	72	973-016-0	Roll Pin (2 x 16)	1	107	976-566-0	Spring (24 x 20 x 1.2)	1
33	970-337-0	Pin (H) (4 x 36)	1	73	976-025-0	Spring (3 x 8.5)	1	112	939-104-0	Allen Wrench (5 mm)	1
34	971-162-0	Pin (2.5 x 22)	1	74	981-208-0	Ball (5/16)	1	113	939-109-0	Allen Wrench (2 mm)	1
35	973-110-0	Roll Pin (3 x 10)	2	75	990-205-0	O-Ring (JW1516-5)	1	114	939-105-0	Allen Wrench (4mm)	1
36	973-114-0	Roll Pin (3 x 14)	2								
37	980-008-0	Round Head Notch (2.4)	1								

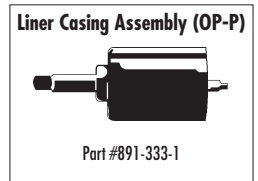

10000 SE PINE
PORTLAND, OR 97216
503-254-6600
FAX 503-255-2615

When ordering spare parts, please specify
tool type, part number, and description.

FOOTNOTES

- = Items in Pulse Repair Kit UX-800-PRK
- = Items in Repair Kit UX-800-RK
- ▲ = Items in Pulse Repair Kit UX-ST800-PRK

UX-800-PRK

(Kit contains following parts)

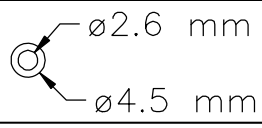
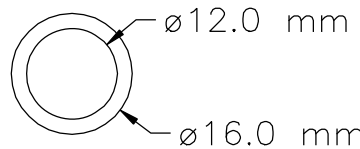
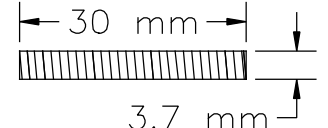
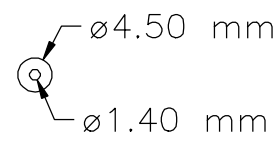
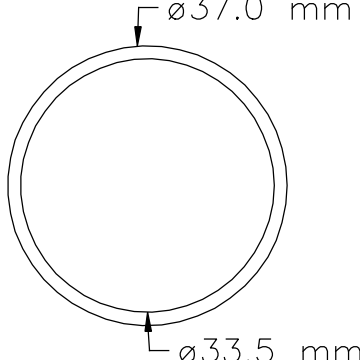
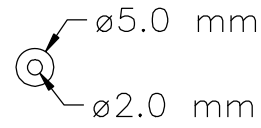
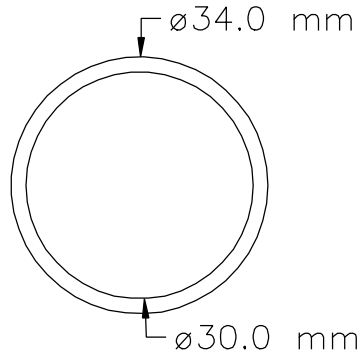
#/#	Bin Location	Part Number	QTY	Description	Material	Drawing / Scketch
1	PA10	944-002-0	2	Support Ring 2.6x4.5x1	Teflon-White	
2	PA10	944-213-0	1	Support Ring 12x16x1	Teflon-White	
3	PA1J	976-800-0	2	Spring 3.7x30 (0.5) WPC	Spring wire ø.50 mm	
4	PA1A	990-320-0	1	O-Ring 4.5x1.4x1.6	Buna-Black	
5	PA1A	990-337-0	1	O-Ring (JW1530-27) 33.5x37x1.75	Buna-Black	
6	PA1B	990-900-0	1	O-Ring 5x2x1.5	Buna-Black	
7	PA1B	990-924-0	1	O-Ring (SNS-30) 30x34x2	Buna-Black	

UX-800-PRK

(Kit contains following parts)

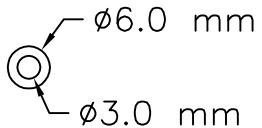
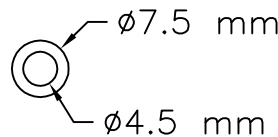
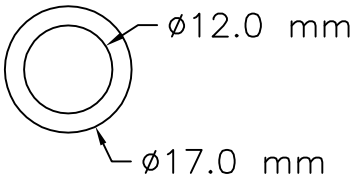
#/#	Bin Location	Part Number	QTY	Description	Material	Drawing / Scketch
8	PA1C	990-971-0	1	O-Ring (SNS-3) (NOK)	Buna-Black	
9	PA1C	990-973-0	1	O-Ring (SNS-5) (NOK)	Buna-Black	
10	PA10	992-020-0	1	SU-Ring (Q-12) (NTN)	Buna-Black	

UX-800-RK

(Kit contains following parts)

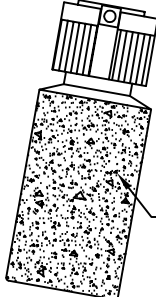
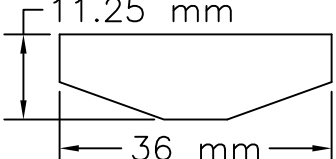
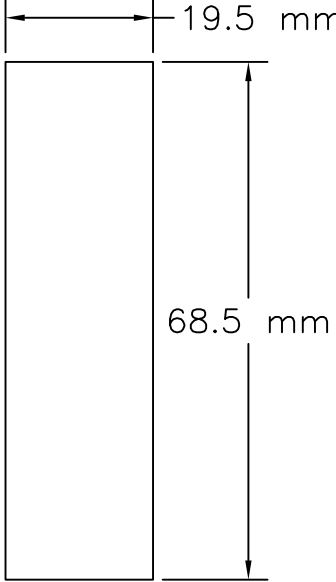
#/#	Bin Location	Part Number	QTY	Description	Material	Drawing / Scketch
1	SEWALL	AM-OIL	1	Oil Air Motor 1 oz. fluid	Plastic Container	 <p style="text-align: right;">Air Oil 1 oz. Scale 1:2</p>
2	PA2B	167-288-6	6	Blade(PC) 8.2x32x1.65	Phenolic-Fiber	 <p style="text-align: right;">11.25 mm 36 mm</p>
3	PA3A	194-835-4	1	Filter 19.5x68.5x1.60	Sended Plastic	 <p style="text-align: right;">19.5 mm 68.5 mm</p>

UX-800-RK

(Kit contains following parts)

#/#	Bin Location	Part Number	QTY	Description	Material	Drawing / Scketch
4	PA4I	194-853-2	1	Rear Packing	Gasket Material	<p style="text-align: center;">Scale 1:2</p>
5	PA4B	194-867-2	1	Front Packing Thickness 0.5 mm	Gasket Material	<p style="text-align: center;">Scale 1:2</p>
6	PA2I	982-403-0	1	Ball Bearing(EE-4) 12.7x28.6x6.3	Bearing Steel	
7	PA2I	982-950-0	1	Ball Bearing(16002) 15x32x8	Bearing Steel	

UX-ST800-PRK

(Kit contains following parts)

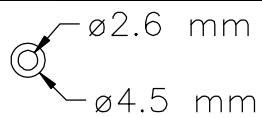
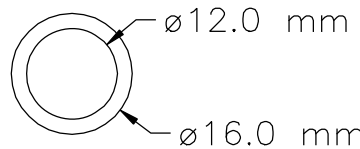
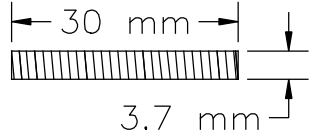
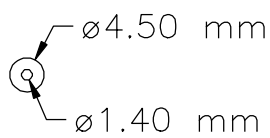
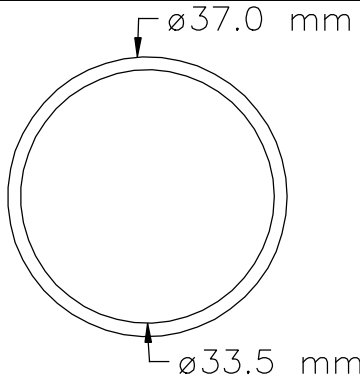
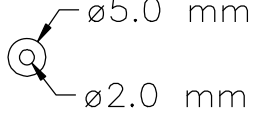
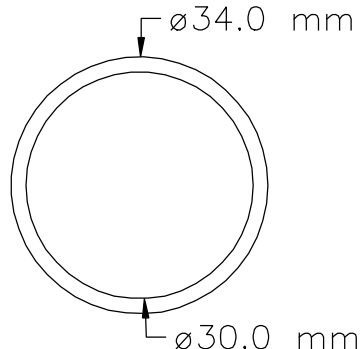
#/#	Bin Location	Part Number	QTY	Description	Material	Drawing / Scketch
1	PA10	944-002-0	2	Support Ring 2.6x4.5x1	Teflon-White	
2	PA10	944-213-0	1	Support Ring 12x16x1	Teflon-White	
3	PA1J	976-800-0	2	Spring 3.7x30 (0.5) WPC	Spring wire ø.50 mm	
4	PA1A	990-320-0	1	O-Ring 4.5x1.4x1.6	Buna-Black	
5	PA1A	990-337-0	1	O-Ring (JW1530-27) 33.5x37x1.75	Buna-Black	
6	PA1B	990-900-0	1	O-Ring 5x2x1.5	Buna-Black	
7	PA1B	990-924-0	1	O-Ring (SNS-30) 30x34x2	Buna-Black	

UX-ST800-PRK

(Kit contains following parts)

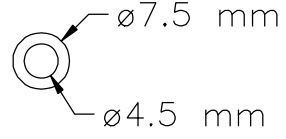
#/#	Bin Location	Part Number	QTY	Description	Material	Drawing / Scketch
8	PA1C	990-971-0	1	O-Ring (SNS-3) (NOK)	Buna-Black	
9	PA1C	990-973-0	1	O-Ring (SNS-5) (NOK)	Buna-Black	
10	PA10	992-020-0	1	SU-Ring (Q-12) (NTN)	Buna-Black	