

UXR-1820 OIL-PULSE TOOLS

EXPLODED VIEW

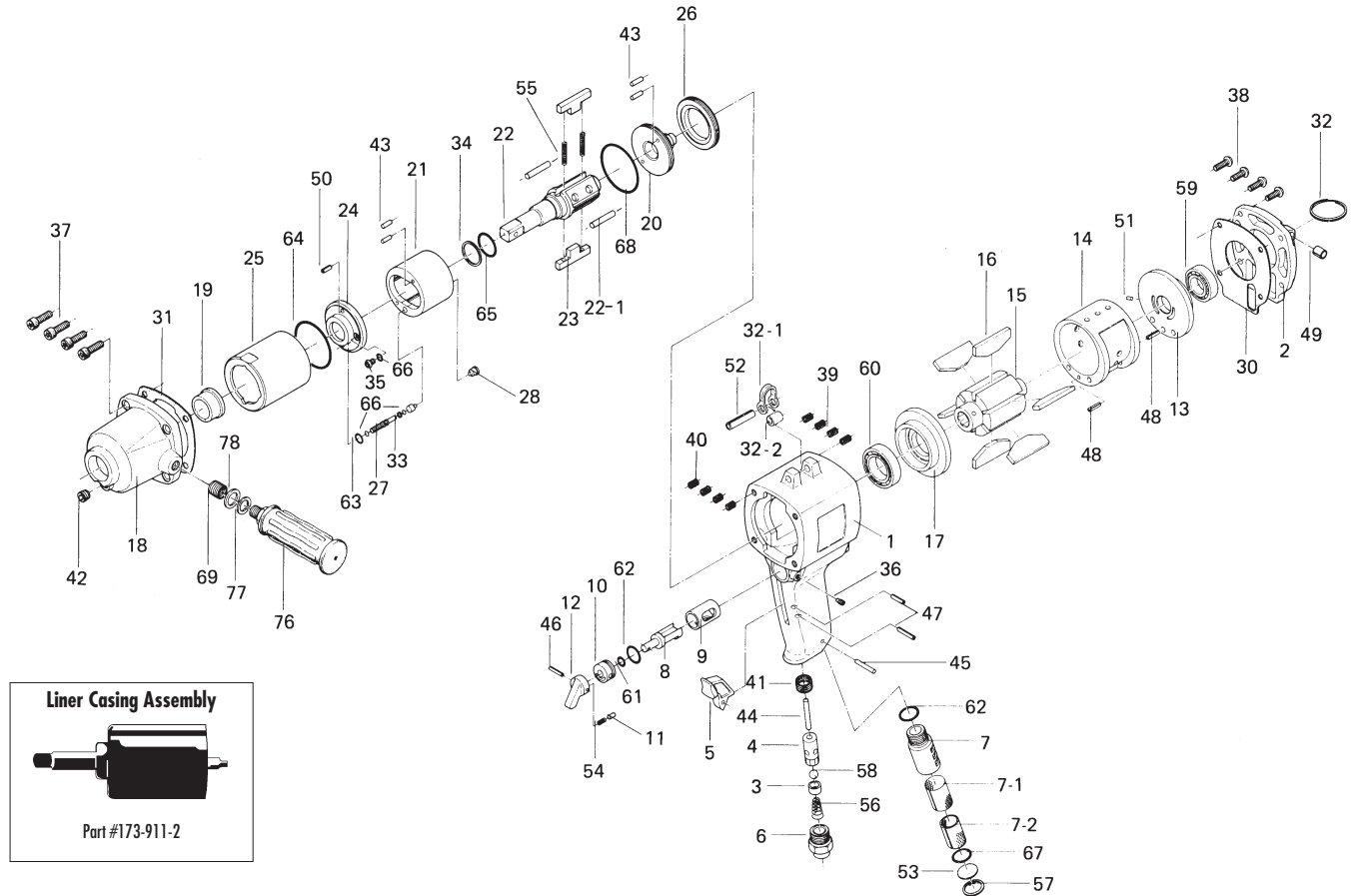

PARTS LIST — FOR REFERENCE ONLY

Index Number	Part Number	Description	Qty.	Index Number	Part Number	Description	Qty.	Index Number	Part Number	Description	Qty.
1	195-025-9	Handle	1	27	182-907-8	Relief Valve Spindle	1	52	969-480-0	Pin (C) (8 x 40)	1
2	195-012-9	Head Cover	1	28	195-969-6	Relief Valve Plug	1	53	975-600-0	Spacer (20 x 1)	1
3	188-100-1	Valve	1	30	195-853-9	Head Cover Packing	1	54	976-025-0	Spring (3 x 8.5)	1
4	063-102-3	Valve Bushing	1	31	195-867-9	Front Casing Packing	1	55	976-796-0	Spring (4.3 x 48) (0.6)	2 ●
5	026-107-7	Valve Lever	1	32	004-790-2	Suspension Ring	1	56	977-180-0	Cone Spring (7.5 x 12 x 22)	1
6	195-091-9	Air Inlet Bushing	1	32-1	195-790-9	Suspension Ring	1	57	979-320-0	Inner Snap Ring (IRTW-20)	1
7	195-780-9	Exhaust Stack	1	32-2	173-796-3	Suspension Bushing	1	58	981-208-0	Ball (5/16)	1
7-1	195-042-9	Silencer	1	33	944-003-0	Supporter Ring (3 x 5 x 1)	1 ●	59	982-103-0	Ball Bearing (6003)	1
7-2	195-835-9	Filter	1	34	944-225-0	Supporter Ring (25.2 x 29.4 x 1.5)	1 ●	60	982-906-0	Ball Bearing (6905)	1
8	189-210-8	Reverse Valve	1	35	945-942-0	Hexagon Round Head Bolt (M4 x 6)	1	61	990-205-0	O-Ring (JW1516-5)	1
9	189-211-8	Reverse Valve Bushing	1	36	952-108-0	Allen Head Dog Point Screw (M4 x 8)	1	62	990-914-0	O-Ring (SNS-16)	2
10	187-222-1	Reverse Valve Setter	1	37	945-220-0	Allen Head Bolt (M6 x 20)	4	63	990-974-0	O-Ring (SNS-6) (NOK)	1 ●
11	054-220-1	Reverse Lever Notch	1	38	945-955-0	Hex. Round Head Bolt (M5 x 16)	4	64	990-941-0	O-Ring (SNS-55)	1
12	023-212-4	Reverse Lever	1	39	965-011-0	Heli-Sert (M5 x 1.5D)	4	65	990-170-0	O-Ring (ARP568-120) (NTN)	1 ●
13	195-285-9	Rear Plate	1	40	965-021-0	Heli-Sert (M6 x 1.5D)	4	66	990-971-0	O-Ring (SNS-3) (NOK)	3 ●
14	195-286-9	Cylinder	1	41	965-118-0	Heli-Sert (M18 x 1.5 x 1D)	1	67	990-916-0	O-Ring (SNS-18)	1
15	195-287-9	Rotor	1	42	966-100-0	Allen Head Plug (1/8)	1	68	990-940-0	O-Ring (SNS-53)	1 ●
16	195-288-9	Blade	6	43	970-308-0	Pin (H) (4 x 8)	4	69	965-058-0	HeliSert (M12 x 10)	1
17	195-289-9	Front Plate	1	44	970-342-0	Pin (H) (4 x 37)	1				
18	195-439-7	Front Casing	1	45	971-163-0	Pin (2.5 x 23)	1				
19	195-328-7	Anvil Bushing	1	46	973-016-0	Roll Pin (2 x 16)	1				
20	195-901-9	Rear Liner Plate	1	47	973-118-0	Roll Pin (3 x 18)	2				
21	195-902-9	Liner	1	48	973-212-0	Roll Pin (4 x 12)	2				
22	173-319-2	Anvil (3/4SQ)	1	49	973-360-0	Roll Pin (8 x 10)	1				
22-1	173-974-2	Roller (3.4 x 45)	2	50	969-405-0	Pin (G) (3.5 x 8)	1				
23	195-440-9	Driving Blade	2	51	973-066-0	Roll Pin (2.5 x 6)	1				
24	195-904-7	Front Liner Plate	1								
25	195-905-9	Liner Casing	1								
26	195-906-9	Liner Casing Setter	1								

ACCESSORIES

74	939-104-0	Allen Wrench (5 mm)	1
75	939-109-0	Allen Wrench (2 mm)	1
76	566-720-2	Dead Handle	1
77	962-013-0	Spring Washer (2-12S)	1
78	975-127-0	Spacer (20 x 13 x 1)	1

FOOTNOTES

● = Items in Pulse Repair Kit UXR-1820-PRK



10000 SE PINE
PORTLAND, OR 97216
503-254-6600
FAX 503-255-2615

When ordering spare parts, please specify tool type, part number, and description.

UXR-1820-PRK

(Kit contains following parts)

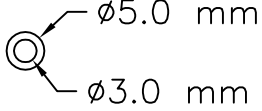
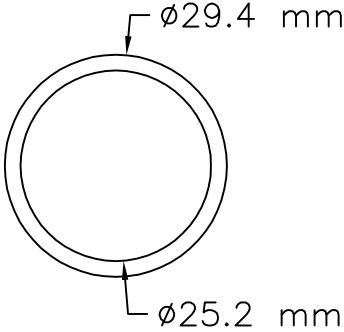
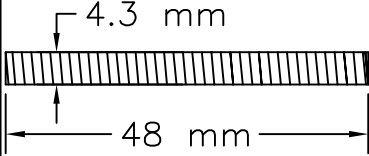
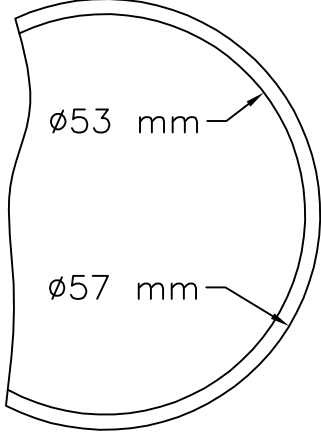
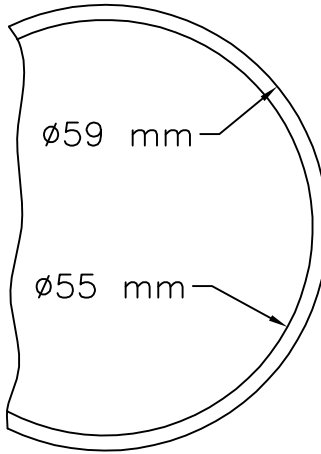
#/#	Bin Location	Part Number	QTY	Description	Material	Drawing / Scketch
1	PA10	944-003-0	1	Support Ring 3.0x5.0x1	Teflon-White	
2	PA10	944-225-0	1	Supporting Ring 25.2x29.4x1.5	Teflon-White	
3	PA1J	976-796-0	2	Spring 4.3x48 (0.6) WPC	Spring wire ø.60 mm	
4	PA1B	990-940-0	1	O-Ring (SNS-53) 53x57x2	Buna-Black	
5	PA1B	990-941-0	1	O-Ring (SNS-55) 55x59x2	Buna-Black	

UXR-1820-PRK

(Kit contains following parts)

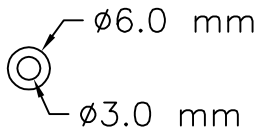
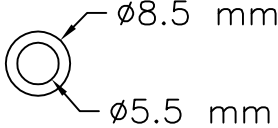
#/#	Bin Location	Part Number	QTY	Description	Material	Drawing / Scketch
6	PA1C	990-971-0	3	O-Ring (SNS-3) (NOK)	Buna-Black	
7	PA1C	990-974-0	1	O-Ring (SNS-6) (NOK)	Buna-Black	
8	PA10	995-500-0	1	Teflon Seal (120) 25x30x3.2	Teflon-Black	