

UXR-T2000 OIL-PULSE TOOLS (TORQUE CONTROL)

EXPLODED VIEW

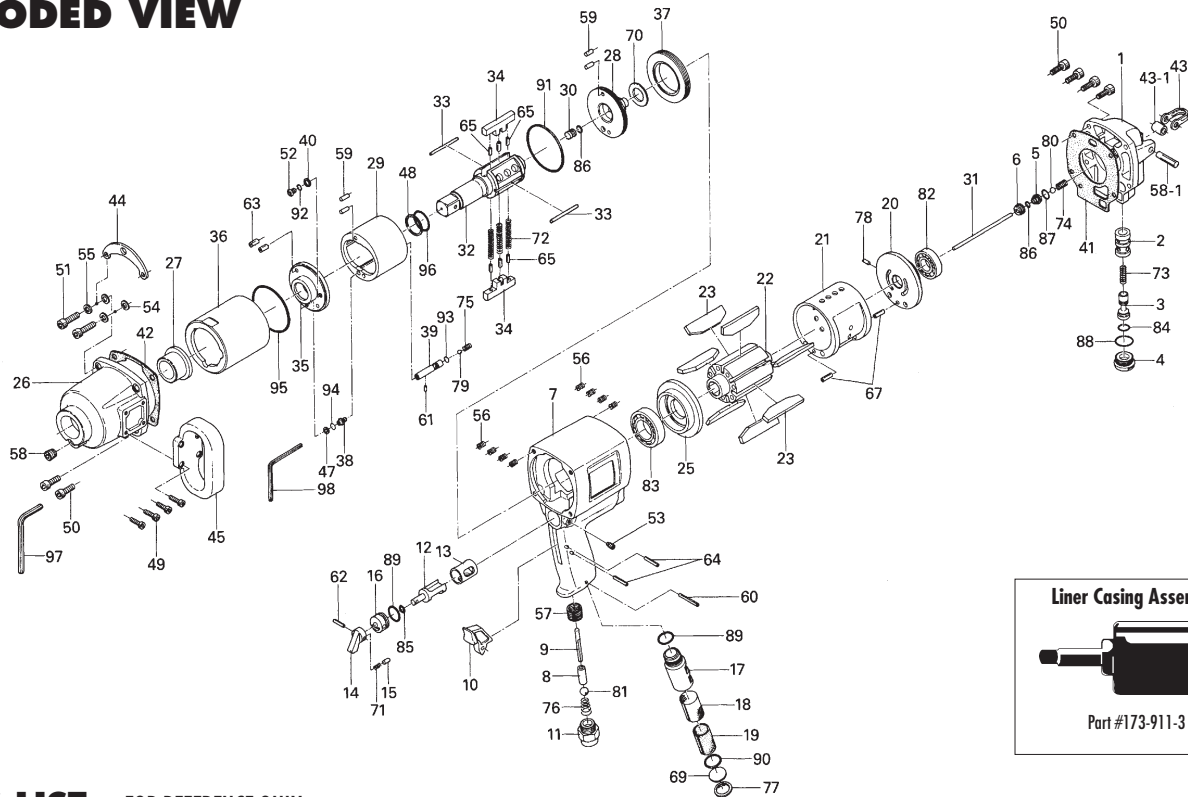

PARTS LIST — FOR REFERENCE ONLY

Index Number	Part Number	Description	Qty.	Index Number	Part Number	Description	Qty.	Index Number	Part Number	Description	Qty.
1	173-012-3	Head Cover	1	36	194-905-8	Liner Casing	1	69	975-603-0	Round Plate (24 x 1)	1
2	173-253-3	Shut-Off Valve Bushing	1	37	194-906-8	Liner Casing Setter	1	70	975-828-0	Adjusting Spacer (34 x 22 x T)	1
3	173-254-3	Shut-Off Valve	1	38	173-907-3	Relief Valve Spindle	1	71	976-025-0	Spring (3 x 8.5)	1
4	175-927-9	Shut-Off Valve Cover	1	39	173-970-3	Relief Valve	1	72	976-797-0	Spring (6.35 x 45.5) (0.8) WPC	3 ●
5	175-968-9	Pilot Valve Retainer	1	40	188-807-1	Spacer	1	73	976-231-0	Spring (9 x 27.5)	1
6	175-019-9	Valve Cover	1	41	173-853-3	Head Cover Packing	1 ■	74	976-275-0	Spring (6.7 x 12)	1
7	173-025-4	Handle	1	42	194-867-8	Front Packing	1 ■	75	976-291-0	Spring (5.5 x 13.8) (0.8)	1 ●
8	087-103-1	Valve Rod Bushing	1	43	195-790-9	Suspension Ring	1	76	977-256-0	Cone Spring (10 x 15 x 22)	1
9	173-104-3	Valve Rod	1	43-1	173-796-3	Suspension Bushing	1	77	979-017-0	Inner Snap Ring (24)	1
10	026-107-7	Throttle Trigger	1	44	194-794-8	Suspension Plate	1	78	980-009-0	Round Head Notch (4)	1
11	194-091-8	Air Inlet Bushing	1	45	090-721-1	Dead Handle	1	79	981-245-0	Ball (4.5 mm)	1
12	194-210-8	Reverse Valve	1	47	944-208-0	Supporting Ring (8.1 x 10 x 1)	1 ●	80	981-006-0	Ball (1/4)	1
13	194-211-8	Reverse Valve Bushing	1	48	944-224-0	Supporting Ring (25.2 x 29.4 x 1.0)	1 ●	81	981-032-0	Ball (7/16)	1
14	023-212-4	Reverse Lever	1	49	945-112-0	Allen Head Bolt (M5 x 12)	4	82	982-203-0	Ball Bearing (6203)	1 ■
15	054-220-1	Reverse Lever Notch	1	50	945-221-0	Allen Head Bolt (M6 x 20)	6	83	982-960-0	Ball Bearing (60/28)	1 ■
16	194-222-8	Reverse Valve Setter	1	51	945-225-0	Allen Head Bolt (M6 x 25)	2	84	990-007-0	O-Ring (P9)	1
17	194-780-8	Exhaust Stack	1	52	945-960-0	Hexagon Round Head Bolt (M6 x 8)	1	85	990-205-0	O-Ring (JW1516-5)	1
18	194-042-8	Silencer Ø0.21 x 30	1	53	952-210-0	Allen Head Dog Point Screw (M5 x 10)	1	86	990-901-0	O-Ring (SNS-3)	2 ●
	176-042-0	Silencer Ø0.21 x 60	1					87	990-907-0	O-Ring (SNS-9)	1
19	176-835-0	Filter	1 ■					88	990-914-0	O-Ring (SNS-16)	1
20	194-285-9	Rear Plate	1	54	961-013-0	Flat Washer (6mm)	2	89	990-918-0	O-Ring (SNS-20)	2
21	194-286-8	Cylinder	1	55	962-078-0	Spring Washer (6.3 x 9.5 x 1.5)	2	90	990-919-0	O-Ring (SNS-22)	1
22	180-287-0	Rotor	1	56	965-021-0	Heli-Sert (M6 x 1.5D)	8	91	990-943-0	O-Ring (SNS-63)	1 ●
23	194-288-8	Blade	7 ■	57	965-120-0	Heli-Sert (M20 x 1D)	1	92	990-949-0	O-Ring (P3) (NOK)	1 ●
25	194-289-8	Front Plate	1	58	966-101-0	Allen Head Plug (1/4)	1	93	990-973-0	O-Ring (SNS-5) (NOK)	1 ●
26	194-439-8	Front Casing	1	58-1	969-481-0	Pin (G) (8 x 45)	1	94	990-977-0	O-Ring (SNS-7) (NOK)	1 ●
27	194-328-8	Anvil Bushing	1	59	970-408-0	Pin (H) (5 x 8)	4	95	990-990-0	O-Ring (SNS-65)	1 ●
28	173-901-3	Rear Liner Plate	1	50	971-166-0	Pin (2.5 x 26)	1	96	995-500-0	Teflon Seal	1 ●
29	173-902-3	Liner	1	61	972-008-0	Roller Pin (2 x 8)	1	99	944-067-0	Supporting Ring, When Used	1 ●
30	173-546-3	Piston	1	62	973-016-0	Roll Pin (2 x 16)	1				
31	173-130-3	Piston Rod (3 x 115.4)	1	63	969-408-0	Pin (G) (5 x 10)	2				
32	18H-319-3	Anvil	1	64	973-118-0	Roll Pin (3 x 18)	2				
33	176-974-5	Roller (4.4 x 55)	2	65	973-208-0	Roll Pin (4 x 8)	6				
34	194-440-9	Driving Blade	2	67	973-316-0	Roll Pin (5 x 16)	2				
35	173-904-3	Front Liner Plate	1								

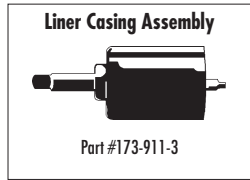

ACCESSORIES

97	939-007-0	Allen Wrench (6 mm)	1
98	939-110-0	Allen Wrench (3 mm) (80 x 80)	1

FOOTNOTES

- = Items in Pulse Repair Kit UXR-T2000-PRK
- = Items in Repair Kit UXR-T2000-RK



10000 SE PINE
PORTLAND, OR 97216
503-254-6600
FAX 503-255-2615

When ordering spare parts, please specify tool type, part number, and description.

UXR-T2000-PRK

(Kit contains following parts)

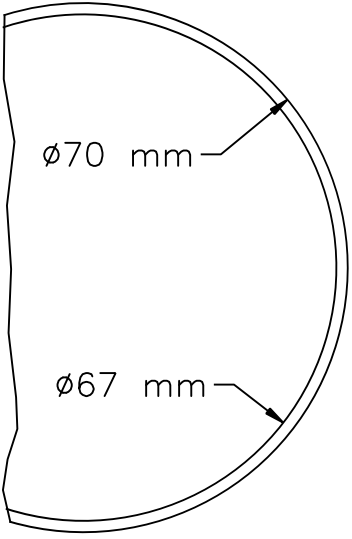
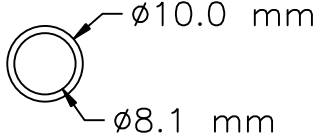
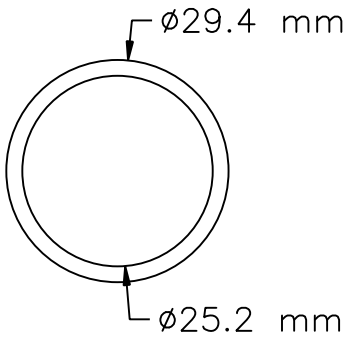
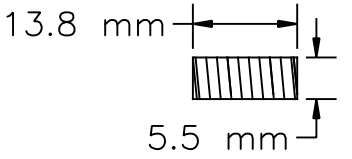
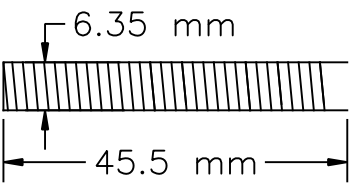
#/#	Bin Location	Part Number	QTY	Description	Material	Drawing / Scketch
1	PA10	944-067-0	1	Supporting Ring 67x70x1	Teflon-White	 <p>Diagram showing a cross-section of a supporting ring. The outer diameter is labeled as $\phi 70$ mm and the inner diameter is labeled as $\phi 67$ mm.</p>
2	PA10	990-208-0	1	Back Up Ring 8.1x10x1	Teflon-White	 <p>Diagram showing a cross-section of a back up ring. The outer diameter is labeled as $\phi 10.0$ mm and the inner diameter is labeled as $\phi 8.1$ mm.</p>
3	PA10	944-244-0	1	Supporting Ring 25.2x29.4x1.0	Teflon-White	 <p>Diagram showing a cross-section of a supporting ring. The outer diameter is labeled as $\phi 29.4$ mm and the inner diameter is labeled as $\phi 25.2$ mm.</p>
4	PA1I	976-291-0	1	Spring 45.5x13.8	Spring wire $\phi 0.8$ mm	 <p>Diagram showing a spring with a length of 13.8 mm and a height of 5.5 mm.</p>
5	PA1J	976-797-0	3	Spring 6.35x45.5	Spring wire $\phi 0.8$ mm	 <p>Diagram showing a spring with a length of 45.5 mm and a height of 6.35 mm.</p>

UXR-T2000-PRK

(Kit contains following parts)

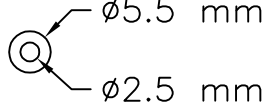
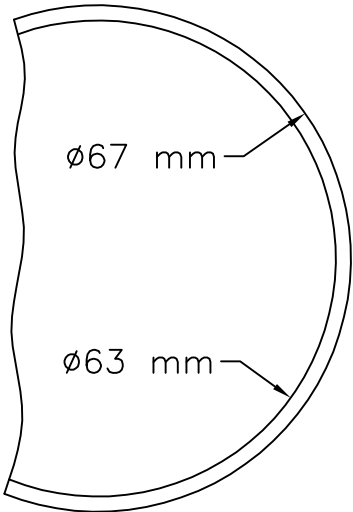
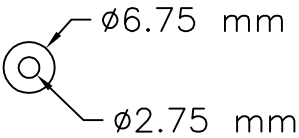
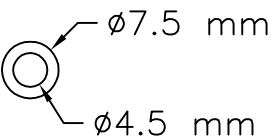
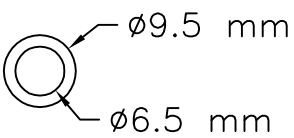
#/#	Bin Location	Part Number	QTY	Description	Material	Drawing / Scketch
6	PA1B	990-901-0	1	O-Ring (SNS-3)	Buna-Black	
7	PA1B	990-943-0	1	O-Ring (SNS-63) 63x67x2	Buna-Black	
8	PA1C	990-949-0	1	O-Ring (P3) (NOK)	Buna-Black	
9	PA1C	990-973-0	1	O-Ring (SNS-5) (NOK)	Buna-Black	
10	PA1C	990-977-0	1	O-Ring (SNS-7) (NOK)	Buna-Black	

UXR-T2000-PRK

(Kit contains following parts)

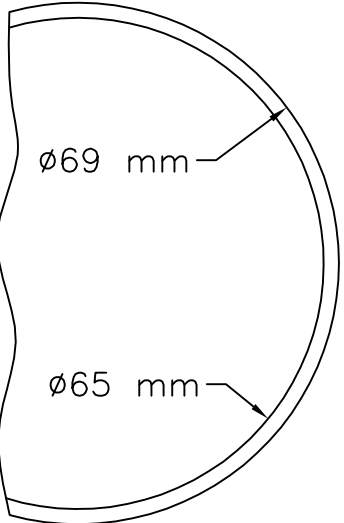
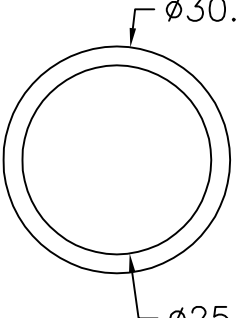
#/#	Bin Location	Part Number	QTY	Description	Material	Drawing / Scketch
11	PA1C	990-990-0	1	O-Ring (SNS-65) 65x69x2	Buna-Black	 <p>ø69 mm</p> <p>ø65 mm</p>
12	PA10	995-500-0	1	Teflon Seal (120) 25x30x3.2	Teflon-Black	 <p>ø30.0 mm</p> <p>ø25.0 mm</p>

UXR-T2000-RK

(Kit contains following parts)

#/#	Bin Location	Part Number	QTY	Description	Material	Drawing / Scketch
1	SEWALL	AM-OIL	1	Oil Air Motor 1 oz. fluid	Plastic Container	
2	PA4B	173-853-3	1	Hed Cover Packing Thickness 0.5 mm	Gasket Material	
3	PA2B	194-288-8	7	Blade 19x70x4.85	Phenolic-Fiber	

UXR-T2000-RK

(Kit contains following parts)

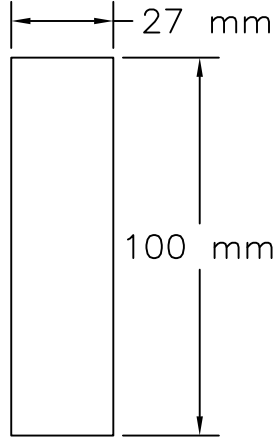
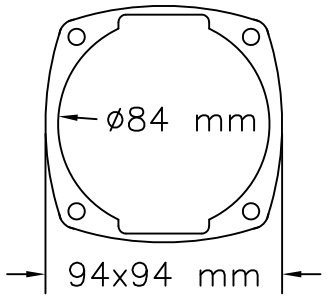
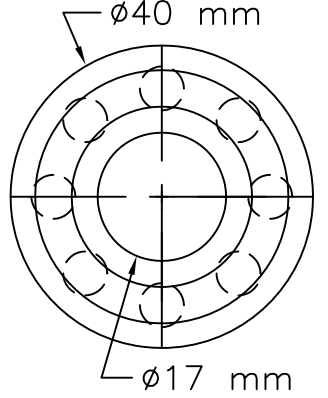
#/#	Bin Location	Part Number	QTY	Description	Material	Drawing / Scketch
4	PA3A	194-835-8	1	Filter 27x100x1.5	Sendered Plastic	 <p style="text-align: center;">Scale 1:2</p>
5	PA1J5	194-867-8	1	Front Packing 94x94x.50	Gasket Material	 <p style="text-align: center;">Scale 1:3</p>
6	PA2H	982-203-0	1	Ball Bearing(6203) 17x40x12	Bearing Steel	

UXR-T2000-RK

(Kit contains following parts)

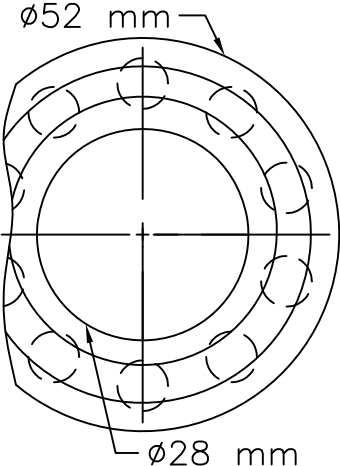
#/#	Bin Location	Part Number	QTY	Description	Material	Drawing / Scketch
7	PA2I	982-960-0	1	Ball Bearing (60/28) (6905) 28x52x12	Bearing Steel	 <p>The drawing shows a cross-section of a ball bearing. It consists of an outer ring with an outer diameter of 52 mm and an inner ring with an inner diameter of 28 mm. The space between the rings contains several balls. The drawing is a technical sketch with dimension lines and arrows pointing to the outer and inner diameters.</p>