

AUDITOR



TORQUE MEASUREMENT SOLUTIONS 2018



AIMCO

For over 40 years AIMCO has been working with manufacturers around the world. We are the complete global source for all critical fastening and bolting solutions. AIMCO can effectively and swiftly meet your needs whether you're in Thailand fastening a 3 mm nut at 3 Nm, or in Tennessee, USA torquing the last lug nut. AIMCO provides the tools and solutions, on a global scale, that guarantee the success of your project. It is with great pride that AIMCO can say the products that we manufacture are **MADE IN THE USA.**

TABLE OF CONTENTS

TORQUE MEASUREMENT

TORQUE MEASUREMENT OVERVIEW	4
TORQUE MEASUREMENT SYSTEMS	7
TORQUE MEASUREMENT TESTERS	8
TORQUE MEASUREMENT ANALYZERS	11
TOOL MANAGER / AUDIT MANAGER SOFTWARE	14
HIGH-CAPACITY TEST STANDS	15
TORQUE WRENCHES	20
TORQUE CARTS	27
DATA COLLECTION SOFTWARE	28
TRANSDUCERS	29
TORQUE MEASUREMENT CABLES	33
INDEX	34



TORQUE MEASUREMENT: OVERVIEW

Torque measurement and the verification of torque tools and applied torque are an integral part of today's threaded assembly process. The method used to measure torque can affect the judgments made regarding tool performance, assembly processes and overall product quality.

DYNAMIC TORQUE

Dynamic torque is the torque produced during the actual tightening process, normally measured using rotary transducers and a torque analyzer.

Advantages:

- Reduces operator influence
- Measures applied torque
- Can also include angle of rotation as error proofing parameter

RESIDUAL TORQUE

Residual torque is the torque measured by producing an incremental amount of movement of the fastener after the actual tightening process, normally measured using a dial or digital torque wrench.

Advantages:

- Easy access to fastener
- Error proofing
- Can detect missed fasteners or joints with significant relaxation

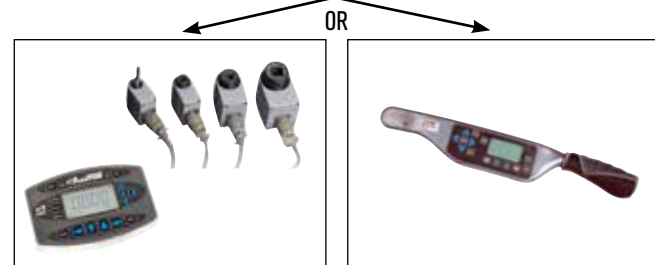
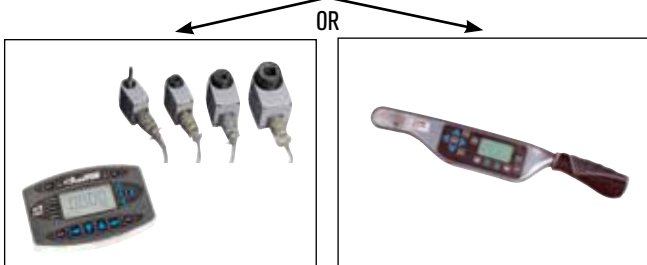
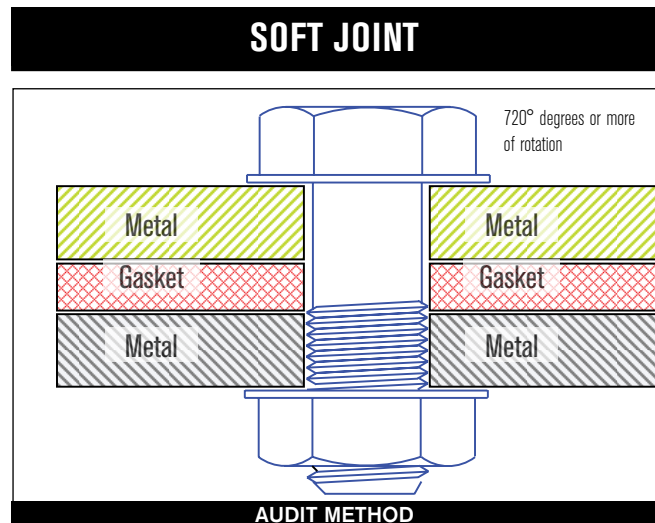
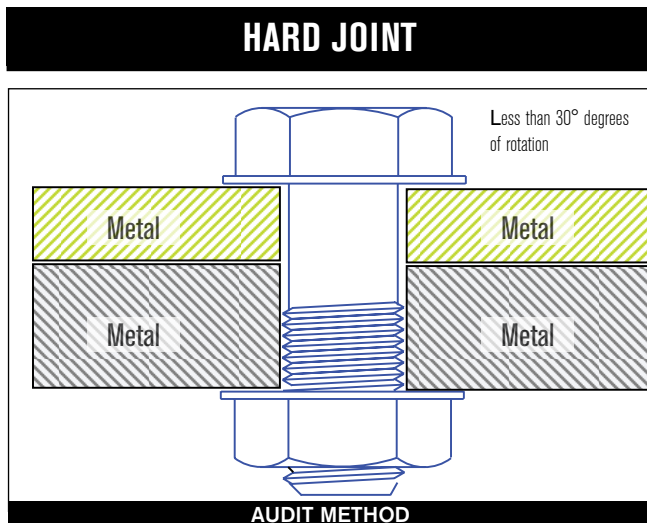

Dynamic Torque: 15 Nm

Residual Torque: 18 Nm

Dynamic Torque: 15 Nm

Residual Torque: 12 Nm

Values as examples only

Values as examples only

A hard joint, one requiring a low degree of rotation during tightening, will normally show very little relaxation after tightening. Due to the high amount of remaining clamp load and friction within the joint members, additional movement of the fastener requires additional torque energy to be applied. Therefore, Residual Torque values will be higher than Dynamic Torque values.

A soft joint, one requiring a high degree of rotation during tightening, will normally show significant amounts of relaxation after tightening. Relaxation leads to a loss of clamp load and friction within the joint members. Due to this relaxation, additional movement of the fastener requires relatively small amounts of additional torque energy and Residual Torque values will be lower than Dynamic Torque values.

TORQUE MEASUREMENT: OVERVIEW

Checking torque measurement before, during, and after assembly ensures quality manufacturing. Proper torque measurement is critical in many assembly operations. AIMCO utilizes years of experience to design a process around your specific auditing requirements. From simple dial wrenches to electronic data collectors and joint analyzers for R&D, AIMCO is with you every step of the way.

BEFORE ASSEMBLY

Tool Capability



Is the tool working correctly?

Testing and verifying tools under controlled conditions helps you identify accuracy and repeatability before using them in production.

Equipment used:

- Desktop testers with internal transducers
- Auditor analyzers with either stationary or rotary transducers
- UFT hydraulic joint simulators and rotary transducers

DURING ASSEMBLY

Process Capability



How does the tool work with the product being assembled?

Testing the tools during the actual process helps ensure that the process is working correctly. Variables in the parts and influences from the operator can be accounted for.

Equipment used:

- Torque Data Collectors/ Analyzers
- Auditor Rotary Transducers

AFTER ASSEMBLY

Product Capability



Does the finished product meet expectations?

Checking the product after assembly is the final opportunity to verify that product quality is satisfactory before user delivery

Equipment used:

- Click/Dial wrenches
- Electronic wrenches with Auditor analyzers
- Rotary transducers and Auditor analyzers with hand driver to move fastener

AUDITOR™

TORQUE MEASUREMENT: OVERVIEW

MEASURING QUALITY – PROCESS CAPABILITY

STATISTICAL ANALYSIS IS AN IMPORTANT STEP IN ANY QUALITY CONTROL PROCESS.

One of the most widely accepted statistical indicators of process quality, and therefore product quality, is Cpk, or the process capability for a centered process. This value indicates how capable a process is and whether the results of that process are properly centered near a specific target. A capable process is one that approaches, as a limit, 100% conformance to specifications.

Cpk is a statistical value that indicates how tightly grouped a series of samples is around the target value. Cpk is a function of the Upper Specification Limit (USL), the Lower Specification Limit (LSL), the mean of the samples and the standard deviation (σ) of the samples.

$$Cpk = \text{either } \frac{(USL - \text{Mean})}{(3 \times \sigma)} \text{ or } \frac{(\text{Mean} - LSL)}{(3 \times \sigma)}, \text{ whichever is smaller.}$$

An acceptable, or capable, process will normally have a Cpk value of at least 1.33.

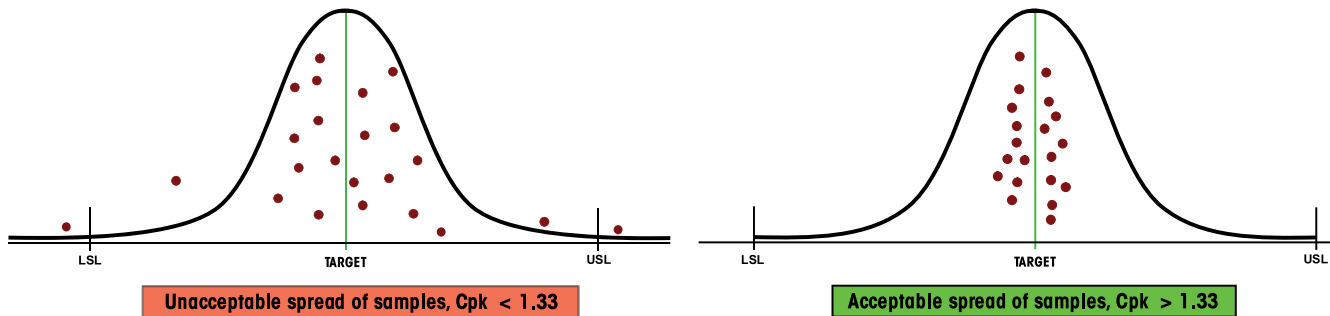

MEASURING QUALITY – CLAMP LOAD

THE PURPOSE OF THREADED FASTENING IS TO PRODUCE THE CORRECT AMOUNT OF CLAMP LOAD WITHIN THE JOINT.

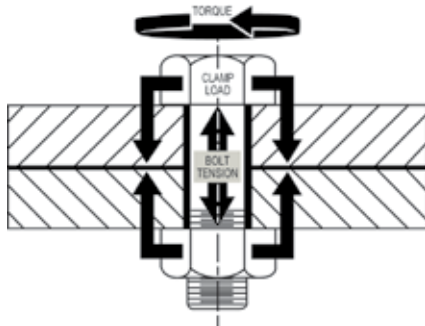

Due to the cost and difficulty of measuring clamp load during the actual assembly process, torque is used as the control parameter during tightening. Many manufacturers use torque values as the primary indicator of threaded assembly quality. However, achieving repeatable clamp load is a better indicator of joint quality.

Studies have shown that discontinuous drive tools can produce equal or better clamp load results when compared to continuous drive tools.

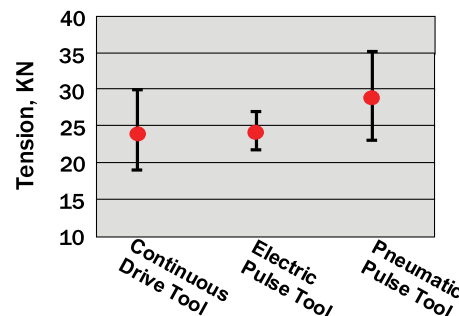
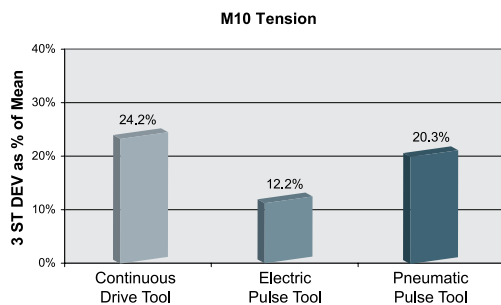

TORQUE MEASUREMENT SYSTEMS



TORQUE MEASUREMENT SYSTEMS										
DEVICES	MODEL SERIES	DATA COLLECTOR	INTEGRATED TRANSDUCER	TORQUE WRENCH	TORQUE WRENCH LOADER	EXTERNAL TRANSDUCER PORT	STATIONARY TRANSDUCERS -SMART	STATIONARY TRANSDUCERS -IND STD	ROTARY TRANSDUCER -SMART	ROTARY TRANSDUCER - IND STD
Testers	ATC		X							
	AUET		X							
	AUET-DC	X	X							
	AUET/MTM		X			X				
	AUET/MTM-DC	X	X			X				
Analyzers	ATDA					X				
	ATDA-DC	X				X				
	ATDA-8000-10-DCA(-TA)(-TP)	X				X				
Test Stands	AHCTS*	X*	X*	X*			X*	X*	X*	X*
	AHCTS-K*	X*	X*	X*			X*	X*	X*	X*
	AHDTs*	X*	X*	X*			X*	X*	X*	X*
	AHBTS*	X*	X*	X*			X*	X*	X*	X*
	AIMTS*	X*	X*	X*			X*	X*	X*	X*
Wrenches	ADW			X						
	ADW-DC	X								
	APTW			X						
	ATW			X						
	ATWL				X					
	Moment Alpha	X		X						
Torque Cart	iTVC*	X*	X*	X*			X*	X*	X*	X*
Transducers	ARTIS									X
	ASTIS							X		
	AISI						X			
	AISF						X			
Rundown Fixtures	AJKR									
	AJKS									
	ARDFA									
	ARDIA									
Joint Simulator	UFT									

*configured to customer specifications





TORQUE MEASUREMENT TESTERS

TORQUE MEASUREMENT: TESTERS

Features and Benefits

- Heavy industrial design
- All software included
- Auditor Torque Testers are designed for intuitive and functional usability. AUET/MTM models are available with our unique dual integrated torque transducer package.

Testers are designed to audit torque wrenches and power tools, including pulse tools

					
	ATC	AUET	AUET/MTM	AUET-DC	AUET/MTM-DC
	Auditor Torque Cube	Auditor Universal Electronic Tester	Auditor Universal Electronic Tester - Multiple Transducer Module	Auditor Universal Electronic Tester - Data Collector	Auditor Universal Electronic Tester/Multiple transducer Module - Data Collector
	Compact vertical or horizontal bench-mount tester.	Bench mount or line side tester utilizing integrated transducer.	Bench mount or line side tester with dual integrated transducer and external transducer capacity.	Bench mount or line side tester utilizing integrated transducer. Provides data collection capability with included software to interface with PC.	Bench mount or line side tester with dual integrated transducer and external transducer capacity. Data collection capability with included software to interface with PC.
Integrated Transducer Range (values are in full scale)	1 - 1,350 Nm 100 in-oz - 1,000 ft-lb	1 - 1,000 Nm 100 in-oz - 750 ft-lb	1 - 1,000 Nm 100 in-oz - 750 ft-lb	1 - 1,000 Nm 100 in-oz - 750 ft-lb	1 - 1,000 Nm 100 in-oz - 750 ft-lb
External Transducer Capacity (Transducer sizes exceeding this range may be special ordered)			up to 5,000 ft-lb		up to 5,000 ft-lb
Vertical / Horizontal Mount	X				
Bi-directional accuracy of +/- X of indicated reading within the top 90% of the tester's capacity	1%	0.50%	0.50%	0.50%	0.50%
Data Output to PC	X	X	X	X	X
Integrated Torque Transducer	1	1	2	1	2
External Transducer Port			X		X
Number of Stored Readings	999	999	999	999	999
Adjustable Rundown Fixture Included *	1	1	2	1	2
Rechargeable NiMH Battery	X	X	X	X	X
Measurement Modes					
Peak	X	X	X	X	X
First Peak (Click)	X	X	X	X	X
Pulse	X	X	X	X	X
Track	X	X	X	X	X
Units of Measure Options	8	8	8	8	8
Tool Manager Software Included				X	X

* Included with all testers and analyzers with a range up to 1000 in-lb.

TORQUE MEASUREMENT TESTERS USED IN CONJUNCTION WITH

External Transducers

ASTIS - Stationary			X		X
AISI / AISF - Stationary - Analog			X		X
ARTIS - Rotary			X		X

Switch box for External Transducer

AISWT-4L > 4 Way Intellect box			X		X
AISWT-6L > 6 Way Intellect box			X		X

Cables

ICBL-USB - USB Serial > PC	X	X	X	X	X
ATDBLIS - IS Transducer w/angle (10 Pin)			X		X
ATDBRIS - IS Transducer (4 Pin)			X		X
ICBL-10P - Intellect transducer cable Identification chip in cable - 10 pin connector			X		X
ICBL-4P - Intellect transducer cable. Identification chip in cable - 4 pin connector			X		X
ICBL-5000L - Connect from AUET/MTM & ATDA to Intellect Transducers, Analog AISI / AISF			X		X

AUDITOR TORQUE CUBE



ATC-10
ATC-25
ATC-100
ATC-250
ATC-500
ATC-750
ATC-1800



ATC-150F
ATC-250F
ATC-500F
ATC-750F



AUDITOR TORQUE CUBE

The Auditor Torque Cube (ATC) is a compact, versatile desktop tester that provides a multitude of capabilities. The ATC is designed to test hand or power tools with the following:

- Peak, first peak, and track modes
- Multiple engineering units
- Manual and auto clear function
- Multiple frequency response settings
- Bi-directional use and accuracy
- Accuracy is better than 1% of indicated reading top 90% of range
- Serial data output
- Memory: 999 data samples
- Battery and/or mains powered

Because precision and quality are critical, you can depend on our testers to calibrate and certify your tools. Whether you are assembling large complicated systems or small precise time pieces, AIMCO provides the best system for your application. Our instruments have been judged "best in class" by independent National Standards laboratories. Auditor Torque Cube is rugged enough to test and verify tools at "point of use" while still being accurate enough to calibrate hand and power tools.

Each tester is shipped with a mains/battery charger power cord, a hex to allen drive bit, and a bolting template. Models with max torque of 1,000 in-lb or less also include a joint rundown fixture. The ATC can be positioned vertically or horizontally for the ergonomic testing of inline or pistol grip tools.

MODEL	RECOMMENDED TORQUE RANGE		WEIGHT		W X H X D		SQUARE DRIVE IN
	NM	IN-LB/FT-LB	KG	LB	MM	IN	
Vertical Configuration							
ATC-10	0.13 - 1.13	1 - 10 in-lb	1.13	2.5	79 x 95 x 83	3.13 x 3.75 x 3.25	1/4
ATC-25	0.28 - 2.83	2.5 - 25 in-lb	1.13	2.5	79 x 95 x 83	3.13 x 3.75 x 3.25	1/4
ATC-100	1.13 - 11.3	10 - 100 in-lb	1.13	2.5	79 x 95 x 83	3.13 x 3.75 x 3.25	1/4
ATC-250	2.83 - 28.3	25 - 250 in-lb	1.13	2.5	79 x 95 x 83	3.13 x 3.75 x 3.25	3/8
ATC-500	5.65 - 56.5	50 - 500 in-lb	1.13	2.5	79 x 95 x 83	3.13 x 3.75 x 3.25	3/8
ATC-750	8.47 - 84.8	75 - 750 in-lb	1.13	2.5	79 x 95 x 83	3.13 x 3.75 x 3.25	3/8
ATC-1800	21.2 - 203	188 - 1,800 in-lb	1.13	2.5	79 x 95 x 83	3.13 x 3.75 x 3.25	1/2
Horizontal Configuration							
ATC-150F	20 - 200	15 - 150 ft-lb	2.25	5	79 x 95 x 83	3.13 x 3.75 x 3.25	1/2
ATC-250F	34 - 340	25 - 250 ft-lb	2.25	5	79 x 95 x 83	3.13 x 3.75 x 3.25	1/2
ATC-500F	68 - 678	50 - 500 ft-lb	2.25	5	79 x 95 x 83	3.13 x 3.75 x 3.25	3/4
ATC-750F	102 - 1,017	75 - 750 ft-lb	2.25	5	79 x 95 x 83	3.13 x 3.75 x 3.25	3/4

AUDITOR BENCH-MOUNT TESTERS



AUET



AUET/MTM



AUET/MTM-DC

AUDITOR UNIVERSAL ELECTRONIC TESTERS

Auditor Universal Electronic Testers (AUET) have a broad range of features to accommodate most requirements. They are designed to be bench-top mounted and are available in several configurations and various single or multiple torque ranges. Onboard memory allows you to capture 999 torque event readings. The testers are also available in file capability (DC) models that require PC software Auditor Tool Manager (ATM).

Instruments up to 1,000 in-lb are supplied with rundown adapters/joint kits. Rundown kits for larger instruments can be ordered separately. AUET/MTM units are supplied with an external transducer port and selector switch for connecting additional transducers.

AUET testers utilize the same transducers as the ATC instruments, providing the same high quality accuracy and durability. The common interface makes the Auditor tester extremely user friendly.



SINGLE TRANSDUCER MODELS

MODEL*	RECOMMENDED TORQUE RANGE	
	KGF-CM/NM	IN-OZ/IN-LB
AUET-050(-DC)	0.4 - 3.6 kgf-cm	5 - 50 in-oz
AUET-0100(-DC)	0.7 - 7.2 kgf-cm	10 - 100 in-oz
AUET-10(-DC)	1.1 - 11.5 kgf-cm	1 - 10 in-lb
AUET-50(-DC)	0.5 - 5.6 Nm	5 - 50 in-lb
AUET-100(-DC)	1.1 - 11.3 Nm	10 - 100 in-lb
AUET-250(-DC)	2.8 - 28.3 Nm	25 - 250 in-lb
AUET-500(-DC)	5.7 - 56.5 Nm	50 - 500 in-lb
AUET-1000(-DC)	11.3 - 113 Nm	100 - 1,000 in-lb
AUET-1200(-DC)	13.6 - 135.6 Nm	120 - 1,200 in-lb
AUET-1800(-DC)	20.3 - 203.4 Nm	180 - 1,800 in-lb

* Add "-DC" to part numbers for data collecting models.

Data collecting models allow multiple files/tools/applications to be associated with torque data. Requires Tool Manager software.

Custom sizes are also available. Contact an AIMCO Customer Service Associate for ordering options, 1-503-254-6600, or toll free 1-800-852-1368.

DUAL TRANSDUCER MODELS

MODEL**	RECOMMENDED TORQUE RANGE			
	TRANSDUCER 1	TRANSDUCER 2	TRANSDUCER 1	TRANSDUCER 2
AUET/MTM-050-25	0.04 - 0.4 Nm	0.3 - 2.8 Nm	5 - 50 in-oz	2.5 - 25 in-lb
AUET/MTM-050-600(-DC)	0.04 - 0.4 Nm	6.8 - 67.8 Nm	5 - 50 in-oz	60 - 600 in-lb
AUET/MTM-0100-050(-DC)	0.07 - 0.71 Nm	0.04 - 0.4 Nm	10 - 100 in-oz	5 - 50 in-oz
AUET/MTM-10-100(-DC)	0.11 - 1.12 Nm	1.3 - 11.3 Nm	1.0 - 10 in-lb	10 - 100 in-lb
AUET/MTM-50-250(-DC)	0.56 - 5.65 Nm	2.8 - 28.3 Nm	5.0 - 50 in-lb	25 - 250 in-lb
AUET/MTM-50-500(-DC)	0.56 - 5.65 Nm	5.7 - 56.5 Nm	5.0 - 50 in-lb	50 - 500 in-lb
AUET/MTM-50-1000(-DC)	0.56 - 5.65 Nm	11.3 - 113 Nm	5.0 - 50 in-lb	100 - 1,000 in-lb
AUET/MTM-100-500(-DC)	1.13 - 11.3 Nm	5.7 - 56.5 Nm	10 - 100 in-lb	50 - 500 in-lb
AUET/MTM-100-1000(-DC)	1.13 - 11.3 Nm	11.3 - 113 Nm	10 - 100 in-lb	100 - 1,000 in-lb
AUET/MTM-100-1200(-DC)	1.13 - 11.3 Nm	13.6 - 135.6 Nm	10 - 100 in-lb	120 - 1,200 in-lb
AUET/MTM-100-1600(-DC)	1.13 - 11.3 Nm	18.1 - 180.8 Nm	10 - 100 in-lb	160 - 1,600 in-lb
AUET/MTM-100-2000(-DC)	1.13 - 11.3 Nm	22.6 - 226 Nm	10 - 100 in-lb	200 - 2,000 in-lb
AUET/MTM-250-1600(-DC)	2.82 - 28.2 Nm	18.1 - 180.8 Nm	25 - 250 in-lb	160 - 1,600 in-lb
AUET/MTM-250-1800(-DC)	2.82 - 28.2 Nm	20.3 - 203.4 Nm	25 - 250 in-lb	180 - 1,800 in-lb
AUET/MTM-250-2500(-DC)	2.82 - 28.2 Nm	28.2 - 282.5 Nm	25 - 250 in-lb	250 - 2,500 in-lb
AUET/MTM-500-2500(-DC)	5.7 - 56.5 Nm	28.2 - 282.5 Nm	50 - 500 in-lb	250 - 2,500 in-lb

Custom sizes are also available. Contact an AIMCO Customer Service Associate for ordering options, 1-503-254-6600, or toll free 1-800-852-1368.

AUDITOR TORQUE MEASUREMENT ANALYZERS

TORQUE MEASUREMENT: ANALYZERS

Features and Benefits

- Auditor Torque Analyzers share similar features across all products and are designed for intuitive and functional usability.
- Connects to AIMCO's line of rotary and stationary transducers



	ATDA	ATDA-DC	ATDA-8000	ATDA-8000-10-DCA(-TA)(-TP)
Auditor Torque Data Analyzer		Auditor Torque Data Analyzer with Data Collection	Auditor Torque Data Analyzer with 7" screen	Auditor Torque Data Analyzer 10" display with Data Collection. TA = Torque & Angle, TP = Torque & Pressure
Portable analyzer to be connected to various transducers		Portable analyzer to be connected to various transducers. Provides data collection capability with included software to interface with PC	7" screen with high resolution display and intuitive user interface	10" touch screen with high resolution display and intuitive user interface with multiplexer
Bi-directional	X	X	X	X
Data Output to PC	X	X	X	X
External Transducer Port	1	1	1	4
Number of stored readings	999	999	999	999
Rechargeable NiMH Battery	X	X	X	X
Digital I/O for external devices	X	X	X	X
<u>Measurement Modes</u>	X	X	X	X
Peak	X	X	X	X
First Peak (Click)	X	X	X	X
Pulse	X	X	X	X
Track	X	X	X	X
Measurement Units	8	8	8	8
Software Included		X	X	X
Barcode Reader Capable			X	X

USED IN CONJUNCTION WITH

Transducers				
AISI / AISF - Analog	X	X		
AISI / AISF - Digital			X	X
ASTIS - Stationary	X	X		
ARTIS - Rotary	X	X		
Wrenches				
ATW	X	X		
Switch boxes for External Transducers				
AISWT-4L > 4 Way Intellect box	X	X		
AISWT-6L > 6 Way Intellect box	X	X		
Cables				
ICBL-USB - USB Serial > PC	X	X		
ATDBLIS - IS Transducer w/ angle (10 Pin)	X	X		
ATDBRIS - IS Transducer (4 Pin)	X	X		
ICBL-10P - Intellect transducer cable. Identification chip in cable 10 pin connector	X	X		
ICBL-4P - Intellect transducer cable. Identification chip in cable 4 pin connector	X	X		
ICBL-5000L - Connect from AUET/MTM & ATDA to Intellect Transducer, Analog AISI / AISF	X	X		
ICBL-8000DIG - Connect from ATDA-8000 series analyzer to Digital AISI / AIFI transducer			X	X

AUDITOR TORQUE DATA ANALYZERS



ATDA-DC

AUDITOR TORQUE DATA ANALYZERS

The Auditor Torque Data Analyzer (ATDA) DC is designed to be portable or conveniently placed on a bench. The tester can be connected to various transducers, as well as transducerized wrenches and rotary or stationary transducers. The user interface is common between the ATC (Cube), AUET, AUET-DC, AUET/MTM, AUET/MTM-DC, ATDA, and ATDA-DC. All of these instruments have similar menus. Additionally, all data collector testers utilize Auditor Tool Manager for tool testing and data management.

The Auditor Torque Data Analyzer is available in two configurations:

- ATDA: A simple torque analyzer with sequential memory, 999 data samples, engineering limits, limited statistical processing average, range, Cp and CpK with serial output
- ATDA-DC: Contains all of the features of the ATDA and has additional file capability. It can associate data with file names and manage data collection with a computer and Auditor Tool Manager software

This is a great “starter” tool management system. It provides testing, archiving, and analysis of tools at single or multiple torque targets. The tool and torque data is stored in a SQL database and can be exported to Excel or any .csv spreadsheet.

MODEL	DESCRIPTION
ATDA	Auditor Torque Data Analyzer
ATDA-DC	Auditor Torque Data Collector

AUDITOR TORQUE DATA ANALYZERS



ATDA-8000

ATDA-8000-10-DCA(-TA)(-TP)

TOUCH SCREEN AUDITOR TORQUE DATA ANALYZERS

Auditor offers the ATDA-8000 and the ATDA-8000-10-DCA(-TA)(-TP). The ATDA-8000 is a touch screen instrument with a high resolution display and user interface that facilitates “point of use” tool validation. The user interface is intuitive and the display provides clear easy to read data. Features and parameter settings are password protected to ensure parameters cannot be inadvertently changed. After initial setup, the instrument provides semi-automatic tool validation and judgment.

The ATDA-8000 is a single channel instrument. The ATDA-8000-10-DCA(-TA)(-TP) is a larger instrument that includes a multiplexor for connection to multiple transducers allowing a wide range of tools to be tested with one instrument. The (-TA) model is designed for torque and angle analysis and the (-TP) model is designed for torque and pressure analysis.

Both the ADTA-8000 and the ATDA-8000-10-DCA(-TA)(-TP) systems work with AIMCO’s line of digital transducers.

MODEL	DESCRIPTION
ATDA-8000	Auditor Torque Analyzer Single channel 7” touch screen point of use validation system
ATDA-8000-10-DCA(-TA)(-TP)	Auditor Torque Analyzer Multiple transducer 10” touch screen point of use validation system



AUDITOR TOOL MANAGER / AUDIT MANAGER

AUDITOR TOOL MANAGER SOFTWARE

Tool Manager Software is included with the purchase of AUET-DC and AUET/MTM-DC data-collecting torque testers, as well as the ADW-DC data-collecting torque wrench. Create a database of tools and store test results with this easy-to-use software integrator to/from tester to PC.

Tool Manager Software

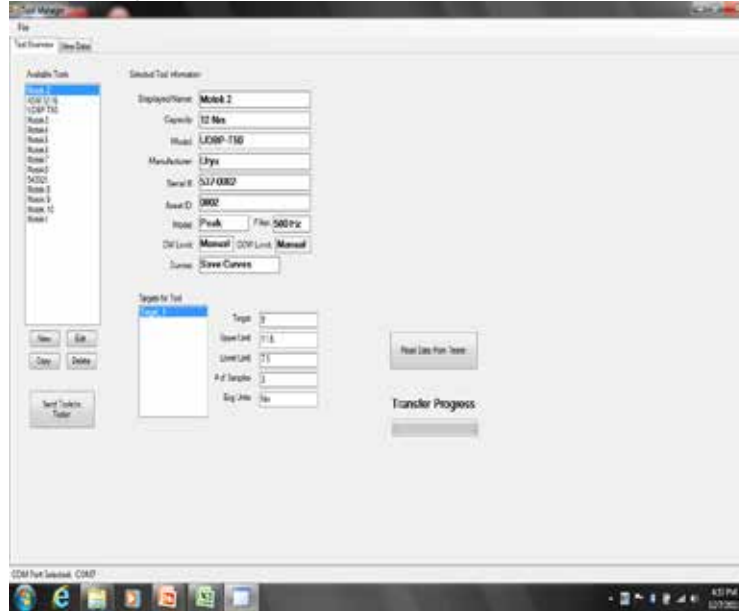

AUDITOR AUDIT MANAGER SOFTWARE

Audit Manager Software is included with the purchase of ATDA-DC data collecting torque analyzers. The View Data tab allows you to look at the collected data and the trace file. This data can be exported to Excel as a .csv file and displayed by Excel charts. The trace file displays the data in a torque/time graph and allows the user to supersede the move-on reading selected by the wrench by visually discerning via the trace where the fastener started to rotate. When selecting a single job the average, range, sigma, Cp, and CpK values are listed.

Audit Manager Software

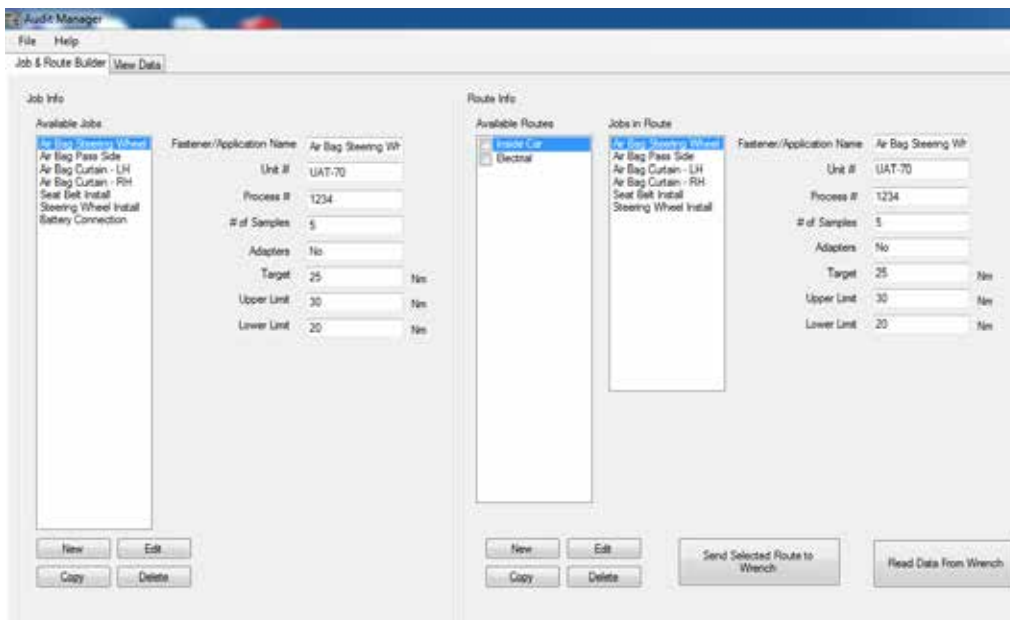





AUDITOR HIGH-CAPACITY TEST STANDS

TORQUE MEASUREMENT: HIGH CAPACITY TEST STANDS

Features and Benefits



- Advanced test stations for larger tools and higher torque output
- Configured to meet application requirements
- Durable industrial grade devices

					
	AHCTS	AHCTS-K	AHDTS	AHBTS	AIMTS
	Auditor High Capacity Test Stand	Auditor High Capacity Test Stand - Hydraulic	Auditor High Capacity Test Stand Dual Transducer	Auditor High Capacity Stand w/variable joint simulation	Auditor High Capacity Impact Test Stand
	Designed for testing tools with continuous rotating output spindles and pulse tools.	Specifically designed for hydraulic wrenches testing.	Two transducers, one for rotary tools and one for hydraulic tools. Includes rundown & reaction fixtures with a single display.	Designed for testing rotating tools without the use of rundown fixtures. Adjustable airbrake joint simulation eliminates CCW rotation after rundown.	Ideal for testing impact wrenches and is recommended to utilize rundown fixtures when testing impacts.
Capacity	6,750 Nm	33,750 Nm	33,750 Nm	6,750 Nm	2,700 Nm

ACCESSORIES

Accessory	AHCTS	AHCTS-K	AHDTS	AHBTS	AIMTS
Rundown fixtures					
AHCTS-3/4RDF	X		X		
AHCTS-1RDF	X		X		
AHCTS-1.5RDF	X		X		

ADAPTERS

			AHCTS	AHCTS-K	AHDTS	AHBTS	AIMTS
Square to Square Drive Adapters*							
	CA1510	1-1/2" Male to 1" Female	X		X	X	
	CA1550	1-1/2" Male to 1/2" Female	X		X	X	
	CA1575	-1/2" Male to 3/4" Female	X		X	X	
Insert Adapters*							
	CA2510I	2-1/2" Male to 1" Female	X		X	X	
	CA2515I	2-1/2" Male to 1-1/2" Female	X		X	X	
	CA2575I	2-1/2" Male to 3/4" Female	X		X	X	
Square to Hex Drive Adapters*							
	CA150108DHD	1-1/2" Male to 1-1/2" Male Hex		X			

* Partial list. Contact an AIMCO Customer Service Associate for more options, 1-503-254-6600, or toll free 1-800-852-1368.

AUDITOR HIGH-CAPACITY TEST STANDS



AHCTS-5000

AHCTS TEST STAND FOR ROTATING TOOLS

Designed for testing tools with continuous rotating output spindles. The test stand includes a rundown fixture, bushing for side load support, reaction post or reaction paddles, transducer and torque analyzer display.

MODEL	DESCRIPTION
AHCTS-0500	3/4" Square Drive w/rundown fixture
AHCTS-2500	1.5" Square Drive w/rundown fixture
AHCTS-5000	1.5" Square Drive w/rundown fixture
AHCTS-7500	1.5" Square Drive w/rundown fixture

Please refer to Configuration Options on following page for required ordering options.



AHCTS-001K

AHCTS-K STAND FOR HYDRAULIC TOOLS

The AHCTS-K stands are specifically designed for hydraulic wrench testing. Hydraulic wrenches have very low profiles but very high torque output, therefore, working height must be minimized to prevent side loading which could lead to errors in data or damage to tool or reaction devices.

Either stand can be ordered with options such as extension legs, casters, embedded or attached torque analyzers with various rundown fixtures and reaction devices. Contact an AIMCO Customer Service Associate for additional information, 1-503-254-6600, or toll free 1-800-852-1368.

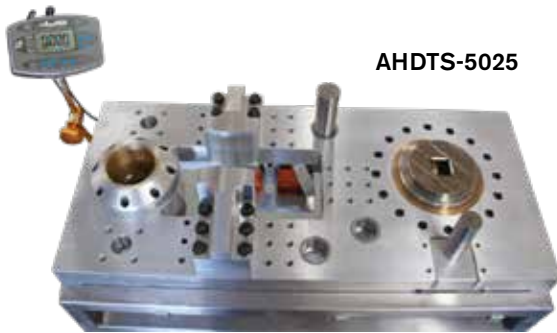

AHDTS-5025

AHDTS DUAL TEST STAND FOR ROTATING AND HYDRAULIC TOOLS

This stand has two transducers embedded into the base, one for rotary tools and one for hydraulic tools. It comes with rundown and reaction fixtures and one display.

MODEL	DESCRIPTION
AHDTS-5025	1.5" Sq Dr dual station w/rundown fixture and reaction devices

Contact an AIMCO Customer Service Associate for ordering options, 1-503-254-6600, or toll free 1-800-852-1368.

MODEL	DESCRIPTION	CAPACITY Ft-Lb
AHCTS-0.5K	3/4" Square Drive w/reaction device	500
AHCTS-001K	1" Square Drive w/reaction device	1,000
AHCTS-2.5K	1.5" Square Drive w/reaction device	2,500
AHCTS-005K	1.5" Square Drive w/reaction device	5,000
AHCTS-010K	1.5" Square Drive w/reaction device	10,000
AHCTS-025K	2" Square Drive w/reaction device	25,000

Please refer to Configuration Options on following page for required ordering options.

Optional Pelican Case shown (ordered separately)



25503

AUDITOR HIGH-CAPACITY TEST STANDS

AHCTS Series High Capacity Test Stands for Rotary and Hydraulic Tools Configuration Options

Base Model Number	Display	Legs	Base Size	Rundown Fixture Capacity (ft-lb)	Reaction Post	Casters	Articulated Arm and Mount	Digital Module
AHCTS-xxxx	1 = ATDA 2 = No Embedded Display 3 = ATDA-DC 4 = ATDA-8000 Digital (7") 5 = ATDA-8000-10 Digital 6 = Standard Embedded Display (1, 3, 4, 5 include articulated arm)	1 = 6" 2 = No legs (Standard) 3 = 18" 4 = Custom	0 = 8 x 8" 1 = 12 x 12" 3 = 14 x 19" (Standard) 4 = 18 x 24" 5 = 18 x 36" 6 = NA	1 = 500 2 = No 3 = 1,000 4 = 2,500 5 = 5,000 6 = 7,500 7 = 1.5" Kit Max. capacity 7,500 Ft-Lb 8 = 2.5" Kit Max. capacity 7,500 Ft-Lb	1 = Single 6" Post and Paddles 2 = No 3 = Multiple Posts 6" 4 = Paddles 5 = Custom 6 = Single 9" Post and Paddles 7 = Multiple Posts 9"	1 = Yes 2 = No	1 = Yes 2 = No	1 = Yes (for Tablet or PC direct) 2 = No
Model Number Digits 1-10	Model # Digit 11	Model # Digit 12	Model # Digit 13	Model # Digit 14	Model # Digit 15	Model # Digit 16	Model # Digit 17	Model # Digit 18

Auditor High Capacity Test Stand for Rotary Tools

AHCTS-0500 680 Nm / 500 ft-lb			0, 1, or 3					
AHCTS-1000 1,360 Nm / 1,000 ft-lb			0, 1, or 3					
AHCTS-2500 3,400 Nm / 2,500 ft-lb			0, 1, or 3					
AHCTS-5000 6,800 Nm / 5,000 ft-lb			0, 1, or 3					
AHCTS-7500 10,200 Nm / 7,500 ft-lb			0, 1, or 3					

Auditor High Capacity Test Stand for Hydraulic Tools

AHCTS-0.5K 680 Nm / 500 ft-lb			0-5 (3-5 come with casters)	2				
AHCTS-001K 1,360 Nm / 1,000 ft-lb			0-5 (3-5 come with casters)	2				
AHCTS-2.5K 3,390 Nm / 2,500 ft-lb			0-5 (3-5 come with casters)	2				
AHCTS-005K 6,800 Nm / 5,000 ft-lb			0-5 (3-5 come with casters)	2				
AHCTS-010K 13,600 Nm / 10,000 ft-lb			0-5 (3-5 come with casters)	2				
AHCTS-025K 34,000 Nm / 25,000 ft-lb			0-5 (3-5 come with casters)	2				
AHCTS-050K 68,000 Nm / 50,000 ft-lb			0-5 (3-5 come with casters)	2				

AUDITOR HIGH-CAPACITY TEST STANDS

AIMTS TEST STAND FOR IMPACT TOOLS

Obtain accurate test results with the AIMTS Series Impact Test Stand. When used with an Auditor ATDA Analyzer or AUET/MTM Desktop Torque Tester, the tool's performance data can be recorded and stored. Each Auditor Analyzer comes standard with PC-based software to store and organize data for use within a quality system. It is necessary to bolt the AIMTS to a bench. We also recommend that a rundown fixture always be used for testing impacts.



AIMTS-0500
Test stand for small impact tools



AIMTS-2000
Test stand for large impact tools

MODEL	DESCRIPTION
AIMTS-0500	3/4" square drive impact test stand
AIMTS-2000	1.5" square drive impact test stand

Refer to Configuration Options below for required ordering options.

AIMTS Series High Capacity Impact Test Stand Configuration Options

Base Model #	Display	Legs	Base Size	Rundown Fixture Capacity (ft-lb)*		Options	Digital Module
AIMTS-xxxx	1 = ATDA 2 = No Embedded Display 3 = ATDA-DC 4 = ATDA-8000 Digital (7") 5 = ATDA-8000-10 Digital	1 = 6" 2 = No legs (Standard) 3 = 18" 4 = Custom	6 = Bench Stand	1 = 500 2 = No 3 = 2,000 4 = 50 5 = 5,000	6 = 10,000 7 = 20,000 8 = 250 9 = 2,500	Not available for AIMTS test stands. Enter 222 for model # digits 15-17	1 = Yes (for Tablet or PC direct) 2 = No
Model Number Digits 1-10	Model Number Digit 11	Model Number Digit 12	Model Number Digit 13	Model Number Digit 14		Model Number Digits 15-17	Model Number Digit 18
AIMTS-0050 68 Nm / 50 ft-lb		2	6			222	
AIMTS-0250 340 Nm / 250 ft-lb		2	6			222	
AIMTS-0500 680 Nm / 500 ft-lb		2	6			222	
AIMTS-2000 2,720 Nm / 2,000 ft-lb		2	6			222	
AIMTS-2500 3,390 Nm / 2,500 ft-lb		2	6			222	
AIMTS-5000 6,780 Nm / 5,000 ft-lb		2	6			222	

* Ordering more than one rundown fixture is highly recommended if you're doing a lot of testing. Having multiple rundown fixtures ensures that you have spares when dealing with heat issues. AIMTS test stands are available in capacities of up to 20,000 ft-lb. Capacities other than what is shown here are quoted separately. Contact an AIMCO Customer Service Associate at 1-503-254-6600, or toll free 1-800-852-1368.

AUDITOR HIGH-CAPACITY TEST STANDS



AHBS-2500
Auto Release test stand for quickly testing large rotating tools

AHBS TEST STAND WITH BRAKING SYSTEM FOR ROTATING TOOLS

These test stands are for testing rotating tools without requiring the use of rundown fixtures. We utilize an airbrake for testing tools that cannot or should not be used in reverse. These test stands are compatible with any Auditor Torque Analyzer.

MODEL	DESCRIPTION
AHBS-2500	1.5" square drive, brake system w/reaction device, rotary transducer and display
AHBS-5000	1.5" square drive, brake system w/reaction device, rotary transducer and display





Refer to Configuration Options below for required ordering options.

AHBS Series High Capacity Test Stand with Brake System Configuration Options

Base Model Number	Display	Legs	Base Size	Rundown Fixture Capacity (ft-lb)	Reaction Post	Casters	Articulated Arm and Mount	Digital Module
AHBS-xxxx	4 = ATDA-8000 Digital (7") 5 = ATDA-8000-10 Digital (Requires Display Controller)	1 = 6" 2 = No legs (Standard) 3 = 18" 4 = Custom	0 = 8 x 8" 1 = 12 x 12" 3 = 14 x 19" (Standard) 4 = 18 x 24" 5 = 18 x 36" 6 = NA	2 = No	1 = Single Post 2 = No 3 = Multiple Posts 6" 5 = Custom 6 = Single Post 9" 7 = Multiple Posts 9"	1 = Yes 2 = No	1 = Yes 2 = No	1 = Yes 2 = No (For Tablet or PC Direct)
Model # Digits 1-10	Model # Digit 11	Model # Digit 12	Model # Digit 13	Model # Digit 14	Model # Digit 15	Model # Digit 16	Model # Digit 17	Model # Digit 18
AHBS-2500 3,400 Nm / 2,500 ft-lb				2				
AHBS-5000 6,800 Nm / 5,000 ft-lb				2				

AUDITOR TORQUE WRENCHES

TORQUE MEASUREMENT: TORQUE WRENCH

Features and Benefits					
	ADW	ADW-DC	APTW	ATW	MOMENT ALPHA
<ul style="list-style-type: none"> Multiple Options from Simple to Sophisticated Similar Interface with other Auditor Products Durable 	* Auditor Digital Wrench	* Auditor Digital Wrench with Data Collection	Auditor Preset Torque Wrench	Auditor Torque Wrench	Digital Torque Wrench with Angle
Torque Range	10 - 500 Nm 7 - 370 ft-lb	10 - 500 Nm 7 - 370 ft-lb	5 - 340 Nm 4 - 250 ft-lb	5 - 200 Nm 4 - 148 ft-lb	Screwdriver: 0.5 - 5 Nm 0.4 - 3.7 ft-lb Wrench: 4 - 1,000 Nm 3.0 - 738 ft-lb
	Digital wrench with multiple head options for line side testing/auditing	Data-collecting digital wrench with multiple head options for line side testing/auditing	Interchangeable heads. Preset uses proprietary adjustment tool to guard against unauthorized setting changes	Transducer on a stick. Communicates with data collecting testers and analyzers	Ensure accuracy in quality OR production applications. Wifi/Bluetooth delivery
Bi-Directional accuracy of +/- X of indicated reading within the top 90% of the tester's capacity	1%	1%	3%	0.50%	±4%
Software Included	X	X			

USED IN CONJUNCTION WITH

ATDA(DC) Data Analyzer				X	
AUET(DC) Tester				X	
AUET/MTM(DC) Tester				X	

TORQUE WRENCH LOADERS



For Calibration of all types of torque wrenches eliminating human variable for more accurate measurement - digital transducer used with ATDA-8000-10-DCA

ATWL-250	Torque range up to 340 Nm / 250 ft-lb
ATWL-750	Torque range up to 1,020 Nm / 750 ft-lb
ATWL-1000	Torque range up to 1,360 Nm / 1,000 ft-lb

AUDITOR DIGITAL WRENCH SERIES



ADW-0010K11131222



ADW-1400F12531222

ADW DATA COLLECTING TORQUE WRENCH

- Large memory capacity
- Every torque value has associated trace file
- “Pick a Point” and “Move On” feature
- Barcode scanner
- Alpha Numeric screen for entering text
- Field replaceable batteries
- Docking station connection
- Serial connection
- Battery charger connection
- Ergonomic handle
- Switch between measure and data collection modes at any time
- Multiple files and route capability
- Data memory and simple statistics “On Board”
- Complete statistical analysis, data archiving and exporting in Audit Manager software
- Five models standard ranges 10 - 500 Nm full scale
- Torsion transducer – not length dependent
- Transducer is replaceable
- 1,400 Nm model uses different handle design

MODEL	TORQUE RANGE		WEIGHT		OVERALL LENGTH		SQ. DRIVE
	NM	FT-LB	LB	KG	IN	MM	IN
ADW-0010K	1 - 10	0.7 - 7.4	2.2	1	18	457.2	1/4
ADW-0075K	7.5 - 75	5.5 - 55	3.1	1.4	23.5	596.9	3/8
ADW-0180K	18 - 180	13 - 130	3.6	1.6	30.1	765.2	1/2
ADW-0270K	27 - 270	20 - 198	3.6	1.6	30.1	765.2	3/4
ADW-0500K	50 - 500	37 - 369	4	1.8	36	914	1
ADW-1400F	140 - 1,400	103 - 1,033	4.8	2.2	60	1,524	1

Unit accuracy is $\pm 1.0\%$ FSD of indicated reading for the top 95% of full scale as indicated above.

Each model includes a case, a battery charger, and a standard square-drive head. Other heads are available at additional cost.

*Part numbers with K, D or F followed by a 1 designate models with file and route capability. K followed by 2 indicate sequential memory but no file capability.

Part numbers with K, D or F followed by a 1,1 indicate file and route with bar code and docking station capability. K, D or F followed by a 1,2 indicate file and route capability with serial port only.

Please refer to the Configuration Options table on following page for required ordering options.



ADW-DS

DOCKING STATION

- Nest for accepting all wrench sizes
- Charger and serial communication accomplished through docking station
- Bench mountable

AUDITOR DIGITAL WRENCH SERIES

ADW Series Digital Torque Wrenches Configuration Options

Base Model Number	Style	Data Collector	Bar Code and Docking Station	Square Drive Size	Type of Transducer	Engineering Unit	Future Options
ADW-xxxx	K = Katana D = Katana with Dovetail Transducer F = Straight Stick	1 = Yes 2 = No	1 = Yes 2 = No (Serial Port Only)	1 = 1/4" 2 = 3/8" 3 = 1/2" 4 = 3/4" 5 = 1" 6 = N/A	1 = Intellect 2 = Industrial Standard 3 = N/A	1 = Nm 2 = Ft-lb 3 = In-lb	Not yet available. Enter 2222 for model # digits 15-18
Model # Digits 1-8	Model # Digit 9	Model # Digit 10	Model # Digit 11	Model # Digit 12	Model # Digit 13	Model # Digit 14	Model # Digits 15-18

Non Data-Collecting (Sequential Memory)

ADW-0010K2 10 Nm / 7.4 ft-lb	K or D	2	2	1 or 2	3	1	2222
ADW-0075K2 75 Nm / 55 ft-lb	K or D	2	2	2	3	1	2222
ADW-0180K2 180 Nm / 130 ft-lb	K or D	2	2	3	3	1	2222
ADW-0270K2 270 Nm / 198 ft-lb	K or D	2	2	3	3	1	2222
ADW-0500K2 500 Nm / 369 ft-lb	K or D	2	2	4	3	1	2222
ADW-1000K2 1,000 Nm / 738 ft-lb	F	2	2	4 or 5	3	1	2222
ADW-1200K2 1,200 Nm / 885 ft-lb	F	2	2	5	3	1	2222
ADW-1000K2 1,400 Nm / 1,033 ft-lb	F	2	2	5	3	1	2222
ADW-1200K2 2,000 Nm / 1,475 ft-lb	F	2	2	5	3	1	2222

Data Collecting (File and Route Capability)

ADW-0010K1 10 Nm / 7.4 ft-lb		1		1 or 2	3	1	2222
ADW-0075K1 75 Nm / 55 ft-lb		1		2	3	1	2222
ADW-0180K1 180 Nm / 130 ft-lb		1		3	3	1	2222
ADW-0270K1 270 Nm / 198 ft-lb		1		3	3	1	2222
ADW-0500K1 500 Nm / 369 ft-lb		1		4	3	1	2222
ADW-1000K2 1,000 Nm / 738 ft-lb	F			4 or 5	3	1	2222
ADW-1200K2 1,200 Nm / 885 ft-lb	F			5	3	1	2222
ADW-1000K2 1,400 Nm / 1,033 ft-lb	F			5	3	1	2222
ADW-1200K2 2,000 Nm / 1,475 ft-lb	F			5	3	1	2222

Standard capacities shown. Additional capacities available on request. Contact an AIMCO Customer Service Associate at 1-503-254-6600, or toll free 1-800-852-1368.

AUDITOR ELECTRONIC TORQUE WRENCHES

ALLOW PRECISE TIGHTENING AND AUDITING OF YOUR ASSEMBLY APPLICATIONS

“TRANSDUCERS ON A STICK”

- Non-Length Dependent – Where the operator's hand is positioned during use has no effect on torque readings
- Available in Industry Standard (IS) or Intelligent (Intellect) Configurations – Transducer is compatible with a wide variety of IS style instruments or Auditor Intellect instruments that self recognize the transducer
- Durable – Steel, Aluminum and Carbon Fiber construction provide optimal strength and weight. Transducer supplied with overload capacity of 150% of full scale
- Accurate – Torque readings are accurate to 1% of indicated reading in top 95% of full scale



MODEL	TORQUE RANGE		SQUARE DRIVE
	NM	FT-LB	IN
ATW-0100F	14 - 136	10 - 100	3/8
ATW-0200F	27 - 272	20 - 200	1/2
ATW-0500F	68 - 680	50 - 500	3/4
ATW-1000F	136 - 1,360	100 - 1,000	1

Unit accuracy is $\pm 0.5\%$ of indicated reading for the top 90% of full scale as indicated above.
 Required Accessory: ATDBRIS IS cable to connect Auditor ATDA instrument.



AUDITOR PRESET TORQUE WRENCHES

FEATURES AND BENEFITS

- Easy-to-use preset wrenches for fastener torque auditing
- Torque ranges from 5 – 340 Nm
- User friendly, sleek, ergonomic design
- Tactile feedback on achievement of preset torque
- Proprietary adjustment tool guards against unauthorized setting changes
- Wide range of interchangeable heads provide flexibility and convenience
- +/- 3% accuracy when used in clockwise or counterclockwise directions



PRESET WRENCHES	DESCRIPTION
APTW-25	Auditor Preset Torque Wrench, 5 - 25 Nm, Accepts 12 mm Inserts
APTW-50	Auditor Preset Torque Wrench, 10 - 50 Nm, Accepts 12 mm Inserts
APTW-100	Auditor Preset Torque Wrench, 20 - 100 Nm, Accepts 12 mm Inserts
APTW-150	Auditor Preset Torque Wrench, 30 - 150 Nm, Accepts 12 mm Inserts
APTW-200	Auditor Preset Torque Wrench, 40 - 200 Nm, Accepts 14 mm Inserts
APTW-340	Auditor Preset Torque Wrench, 60 - 340 Nm, Accepts 14 mm Inserts

RATCHET AND SQUARE DRIVE HEADS	DESCRIPTION
9 x 12	
APTH-12RT25	Auditor Preset Torque Wrench Ratchet Insert, 1/4 SQ DR, 12 mm
APTH-12RT38	Auditor Preset Torque Wrench Ratchet Insert, 3/8 SQ DR, 12 mm
APTH-12RT50	Auditor Preset Torque Wrench Ratchet Insert, 1/2 SQ DR, 12 mm
APTH-12SD25	Auditor Preset Torque Wrench SQ DR Insert, 1/4 SQ DR, 12 mm
APTH-12SD38	Auditor Preset Torque Wrench SD DR Insert, 3/8 SQ DR, 12 mm
APTH-12SD50	Auditor Preset Torque Wrench SQ DR Insert, 1/2 SQ DR, 12 mm
14 x 18	
APTH-14RT50	Auditor Preset Torque Wrench Ratchet Insert, 1/2 SQ DR, 14 mm
APTH-14RT34	Auditor Preset Torque Wrench Ratchet Insert, 3/4 SQ DR, 14 mm
APTH-14SD50	Auditor Preset Torque Wrench SQ DR Insert, 1/2 SQ DR, 14 mm



OPEN END HEADS	DESCRIPTION
9 x 12	
APTH-120E7	Auditor Preset Torque Wrench Insert 7 mm OE, 12 mm
APTH-120E8	Auditor Preset Torque Wrench Insert 8 mm OE, 12 mm
APTH-120E9	Auditor Preset Torque Wrench Insert 9 mm OE, 12 mm
APTH-120E10	Auditor Preset Torque Wrench Insert 10 mm OE, 12 mm
APTH-120E11	Auditor Preset Torque Wrench Insert 11 mm OE, 12 mm
APTH-120E12	Auditor Preset Torque Wrench Insert 12 mm OE, 12 mm
APTH-120E13	Auditor Preset Torque Wrench Insert 13 mm OE, 12 mm
APTH-120E14	Auditor Preset Torque Wrench Insert 14 mm OE, 12 mm
APTH-120E15	Auditor Preset Torque Wrench Insert 15 mm OE, 12 mm
APTH-120E16	Auditor Preset Torque Wrench Insert 16 mm OE, 12 mm
APTH-120E17	Auditor Preset Torque Wrench Insert 17 mm OE, 12 mm
APTH-120E18	Auditor Preset Torque Wrench Insert 18 mm OE, 12 mm
APTH-120E19	Auditor Preset Torque Wrench Insert 19 mm OE, 12 mm
APTH-120E20	Auditor Preset Torque Wrench Insert 20 mm OE, 12 mm
14 x 18	
APTH-140E1	Auditor Preset Torque Wrench Insert 1" OE, 14 mm
APTH-140E13	Auditor Preset Torque Wrench Insert 13 mm OE, 14 mm
APTH-140E14	Auditor Preset Torque Wrench Insert 14 mm OE, 14 mm
APTH-140E15	Auditor Preset Torque Wrench Insert 15 mm OE, 14 mm
APTH-140E16	Auditor Preset Torque Wrench Insert 16 mm OE, 14 mm
APTH-140E17	Auditor Preset Torque Wrench Insert 17 mm OE, 14 mm
APTH-140E18	Auditor Preset Torque Wrench Insert 18 mm OE, 14 mm
APTH-140E19	Auditor Preset Torque Wrench Insert 19 mm OE, 14 mm
APTH-140E21	Auditor Preset Torque Wrench Insert 21 mm OE, 14 mm
APTH-140E22	Auditor Preset Torque Wrench Insert 22 mm OE, 14 mm
APTH-140E24	Auditor Preset Torque Wrench Insert 24 mm OE, 14 mm
APTH-140E25	Auditor Preset Torque Wrench Insert 25 mm OE, 14 mm
APTH-140E27	Auditor Preset Torque Wrench Insert 27 mm OE, 14 mm
APTH-140E30	Auditor Preset Torque Wrench Insert 30 mm OE, 14 mm
APTH-140E32	Auditor Preset Torque Wrench Insert 32 mm OE, 14 mm
APTH-140E34	Auditor Preset Torque Wrench Insert 34 mm OE, 14 mm
APTH-140E36	Auditor Preset Torque Wrench Insert 36 mm OE, 14 mm
APTH-140E38	Auditor Preset Torque Wrench Insert 38 mm OE, 14 mm
APTH-140E41	Auditor Preset Torque Wrench Insert 41 mm OE, 14 mm
APTH-140E118	Auditor Preset Torque Wrench Insert 1-1/8" OE, 14 mm
APTH-140E138	Auditor Preset Torque Wrench Insert 1-3/8" OE, 14 mm

MOMENT ALPHA DIGITAL TORQUE WRENCH

ENSURE ACCURACY IN QUALITY OR PRODUCTION APPLICATIONS

FEATURES

- Torque *and* angle measurement
- Modular system with self-identifying accessories
- Wireless delivery WiFi/Bluetooth
- One wrench/tablet analyzer to perform audits in full torque range from 0.5 – 1,000 Nm (with optional accessories)
 - Screwdriver mode from 0.5 – 5 Nm
 - Flexion mode (wrench) from 4 – 1,000 Nm
- Works in both clockwise and counter-clockwise operation
- Uses standard drive adapters (see page 24)
- Tactile feedback to operator
- Rechargeable battery pack (wrench handle)



KIT MODEL*	PARTS INCLUDED
Production	
CPSKS00	Includes (1) Wrench, (1) Wrench Battery, (1) Battery Charger, (1) 40 Nm Adapter, (1) Production Controller, Production Premium Software, (1) 200 Nm Extension, (1) 600 Nm Extension, and (1) 14 x 18 Ratchet Head (see p. 24)
CPSMH00	Includes (1) Wrench, (1) Wrench Battery, (1) Battery Charger, (1) 40 Nm adapter, (1) Production Controller, and Production Premium Software
Quality	
CPSKU00	Includes (1) Wrench, (1) Wrench Battery, (1) Battery Charger, (1) 40 Nm Adapter, (1) Quality Controller, Quality Premium Software, (1) 200 Nm Extension, (1) 600 Nm Extension, and (1) 14 x 18 Ratchet Head (see p. 24)
CPSMJ00	Includes (1) Wrench, (1) Wrench Battery, (1) Battery Charger, (1) 40 Nm Adapter, (1) Quality Controller, Quality Premium Software

* Additional kits available. Contact an AIMCO Customer Service Associate, 1-503-254-6600, or toll free 1-800-852-1368.

WRENCH HANDLE	TORQUE RANGE	LENGTH	WEIGHT	TORQUE TRANSDUCER ACCURACY	TIGHTENING ACCURACY	ANGLE TRANSDUCER ACCURACY
CPSKV00	Screwdriver Mode: 0.5 - 5 Nm Wrench Mode: 4 - 40 Nm (requires CPSJP81 adapter) 4 - 1,000 Nm (with appropriate extension*)	7.9" 200 mm	0.82 lb 0.37 kg	ISO 6789 < 1%	< ±4%	±1%

* Wrench handle supplied with battery. Specific extensions for specific torques available separately (see page 26).

MOMENT ALPHA DIGITAL TORQUE WRENCH

REMOTE DISPLAY



CPSKR82

FEATURES

- Pre-set tightening settings
- Audible alarm
- Four tightening modes: Torque, Angle, Torque and Angle, Angle and Torque
- 2.4" color display touchscreen
- International units: Nm, kg/m, kp/m, ft-lb, in-lb, ft-oz, in-oz
- Sturdy and suited to industrial environments

MODEL	DESCRIPTION	SIZE	WEIGHT
CPSKR81	Production Controller w/out software	7.1" x 13.8" x 5.9" 180 x 350 x 150 mm	7.05 lb 3.2 kg
CPSKT82	Quality Controller w/out software	8.7" x 5.4" x 1.3" 221 x 138 x 32 mm	1.05 lb 0.5 kg
CPSKS50	Production Premium Software	-	-
CPSKU50	Quality Premium Software	-	-

ACCESSORIES



CPSJP75
Battery Unit

CPSJP73
Battery
Charger

CPSJP81
40 Nm Adapter



CPSKS82
600 Nm Extension

CPSKS81
200 Nm Extension

MODEL	DESCRIPTION	SIZE	END EFFECTOR CONNECTION	WEIGHT
CPSJP75	Battery Unit (includes 3 rechargeable AA batteries)	-	-	-
CPSJP73	Battery Charger	-	-	-
CPSJP81	Adapter 40 Nm	3.5" / 89 mm	-	0.03 lb 0.01 kg
CPSKS86	Extension 100 Nm	5.71" / 145 mm	14 x 18*	0.06 lb 0.03 kg
CPSKS81	Extension 200 Nm	14.41" / 366 mm	14 x 18*	1.1 lb 0.5 kg
CPSKS85	Extension 300 Nm	27.06" / 688 mm	14 x 18*	2.6 lb 1.2 kg
CPSKS87	Extension 400 Nm	30.27" / 769 mm	14 x 18*	3.08 lb 1.4 kg
CPSKS82	Extension 600 Nm	42.72" / 1,085 mm	14 x 18*	5.07 lb 2.3 kg
CPSKS88	Extension 1,000 Nm	70.86" / 1,800 mm	1 in.*	5.07 lb 2.3 kg

* End Effectors sold separately. See page 24.

TORQUE CARTS

TORQUE MEASUREMENT: TORQUE CARTS

Features and Benefits

- Test on repeatable joint simulators or production joints
- Simple to sophisticated options
- Manual or self-propelled
- Mobile test carts can be configured for testing continuous and discontinuous drive tools that include DC electric, clutch, battery, impulse, and torque wrenches
- Each cart is customizable to meet testing needs from 1 - 1,356 Nm

Contact your AIMCO representative for a quote or more information



iTVC

Hydraulic Braking Technology

- Dry braking with multiple hydraulic cylinders where thrust is generated equally to allow better linear control of the braking ramp
- Programmable joint characteristics for use with continuous drive tools - no unwinding required after testing

UFT Repeatable Joint Simulator

- Mechanically adjustable hydraulic pressure circuits allow the bolt tightening body to be configured to simulate various joint characteristics
- Ideal for repeatable, linear joint rate simulation while testing all tools including impulse tools

DataPro Software

Torque Wrench Loader Option

X

X

X

* Optional equipment - extension added to cart

AUDITOR TORQUE CART



iTVC Torque Cart

AIMCO offers torque carts for “lineside” or “point of use” tool validation and calibration. Our torque carts allow testing of tools on repeatable joint simulators and “in process” use on production joints, allowing users to identify process capability. There are multiple torque cart options:

- Manual push carts equipped with simple torque testers
- Manual push carts equipped with data collectors and database application software
- Self propelled cart with computer and relational database application
- Driven cart with computer and relational database application

Each cart can be equipped to specific customer requirements. Maximum torque range on board torque cart is 1,356 Nm or 1,000 ft-lb. Ancillary test stands up to 50,000 ft-lb available.

TRANSDUCERS



TORQUE MEASUREMENT: TRANSDUCERS

Features and Benefits

Superior:

- Accuracy
- Compatibility
- Durability

Auditor offers multiple styles of transducers in various configurations. Industry standard transducers (2mv/v) and intellect transducers for Auditor instruments that reduce configuration set up time.

	Rotary	Stationary	
			
	ARTIS	ASTIS	AISI - AISF*
	Auditor Rotary Transducer Industry Standard	Auditor Stationary Transducer Industry Standard	Auditor Industry Standard Stationary

Used in Conjunction with Analyzer

ATC	X		
AUET	X		
AUET/MTM	X	X	X
ATDA	X	X	X
ATDA-8000			X

* See Configuration Options on following page to configure complete part number for AISI / AISF models. Please contact an AIMCO Customer Service Associate for additional information, 1-503-254-6600, or toll free 1-800-852-1368.

AUDITOR ROTARY TRANSDUCERS

Suitable for use with all continuous drive tools, impulse tools and torque wrenches.



ARTIS Series

MODEL	DRIVE	MAX TORQUE		WEIGHT
	IN	NM	IN-LB/FT-LB	LB
ARTIS-25H-2T(A)	1/4 Hex	2	18 in-lb	1.0
ARTIS-25H-5T(A)	1/4 Hex	5	44 in-lb	1.0
ARTIS-25H-10T(A)	1/4 Hex	10	88 in-lb	1.0
ARTIS-25H-20T(A)	1/4 Hex	20	180 in-lb	1.0
ARTIS-25S-10T(A)	1/4 Sq.	10	88 in-lb	1.0
ARTIS-25S-20T(A)	1/4 Sq.	20	180 in-lb	1.0
ARTIS-38S-25T(A)	3/8 Sq.	25	225 in-lb	1.2
ARTIS-38S-75T(A)	3/8 Sq.	75	50 ft-lb	1.2
ARTIS-50S-180T(A)	1/2 Sq.	180	130 ft-lb	1.5
ARTIS-75S-250T(A)	3/4 Sq.	250	180 ft-lb	2.2
ARTIS-75S-500T(A)	3/4 Sq.	500	370 ft-lb	2.2
ARTIS-100S-750T(A)	1 Sq.	750	553 ft-lb	4.0
ARTIS-100S-1400T(A)	1 Sq.	1400	1,025 ft-lb	4.0

*Add "A" to the end of the part number to indicate torque/angle transducer.

TRANSDUCERS

AUDITOR STATIONARY TRANSDUCERS

Stationary Transducers with joint rundown fixtures and, where applicable, bench stands.



ASTIS

ASTIS industry standard transducers can be used with multiple analyzers.

MODEL	MAX TORQUE		DRIVE IN
	NM	IN-LB/FT-LB	
ASTIS-25D-11	11	100 in-lb	1/4
ASTIS-25D-28	28	250 in-lb	1/4
ASTIS-38D-135	135	100 ft-lb	3/8
ASTIS-50D-270	270	200 ft-lb	1/2
ASTIS-75D-1000	1017	750 ft-lb	3/4
ASTIS-100D-1700	1,695 Nm	750 ft-lb	1
ASTIS-100S-3000	4,100 Nm	3,000 ft-lb	1



AISI

AISI / AISF Transducers connect to the ATDA-8000 analyzer and mount directly to a benchtop.

MODEL*	MAX TORQUE		WEIGHT		W X H X D		DRIVE IN
	NM	IN-LB/FT-LB	KG	LB	MM	IN	
AISI-200025	2.8	25	1.13	2.5	79 x 95 x 83	3.13 x 3.75 x 3.25	1/4
AISI-200100	11.3	100	1.13	2.5	79 x 95 x 83	3.13 x 3.75 x 3.25	1/4
AISI-200500	56.5	500	1.13	2.5	79 x 95 x 83	3.13 x 3.75 x 3.25	3/8
AISF-200100	135.6	1,200/100	2.25	5	100 x 65	4 x 3	1/2
AISF-200250	339	3,000/250	2.25	5	100 x 65	4 x 3	1/2
AISF-201000	1,350	12,000/1,000	2.8	6	100 x 65	4 x 3	1

* See Configuration Options below to configure complete part number for AISI / AISF models.

Auditor AISI / AISF Industry Standard Transducers Configuration Options

Base Model #	Angle	Capacity	Configuration	Expanded Range*	Digital	Drive Size	Wireless
Model # Digits 1-5	Model # Digit 6	Model # Digits 7-11	Model # Digit 12	Model # Digit 13	Model # Digit 14	Model # Digit 15	Model # Digit 16
	2 = No	00025 = 25 in-Lb / 25 Ft-Lb 00050 = 50 in-Lb / 50 Ft-Lb 00100 = 100 in-Lb / 100 Ft-Lb 00250 = 250 in-Lb / 250 Ft-Lb 00350 = 350 in-Lb / 350 Ft-Lb 00500 = 500 in-Lb / 500 Ft-Lb 00600 = 600 in-Lb / 600 Ft-Lb 00750 = 750 in-Lb / 750 Ft-Lb 01000 = 1,000 in-Lb / 1,000 Ft-Lb	1 = Bench Stand 2 = Inline 3 = Loader (1000 Series Only)	1 = Yes 2 = No	1 = Yes 2 = No	1 = 1/4" Hex (up to 100 In-Lb / 8.3 Ft-Lb) 2 = 1/4" Sq. (up to 100 In-Lb / 8.3 Ft-Lb) 3 = 3/8" Sq. (150-500 In-Lb / 12.5-41.7 Ft-Lb) 4 = 1/2" Sq. (1,800-3,000 In-Lb / 150-250 Ft-Lb) 5 = 3/4" Sq. (3,000-12,000 In-Lb / 250-1,000 Ft-Lb) 6 = 1" Sq. (12,000-24,000 In-Lb / 1,000-2,000 Ft-Lb) 7 = 1-1/2" Sq. (24,000+ In-Lb / 2,000+ Ft-Lb)	2 = No
Stationary							
AISI- (in-lb capacities)	2						2
AISF- (ft-lb capacities)	2						2

*Standard range is 10%-100% of maximum capacity. Expanded range is 5%-100% of maximum capacity.

Transducers are available in capacities of up to 10,000 Ft-Lb. Contact an AIMCO Customer Service Associate at 1-503-254-6600, or toll free 1-800-852-1368.

RUNDOWN FIXTURES

TORQUE MEASUREMENT: RUNDOWN FIXTURES

Features and Benefits

- Enables accurate and repeatable testing of pneumatic or electric power tools
- Mechanical Belleville system of bolt, nut or nut body, Belleville washers and main housing, 1/4" - 3/4" drive sizes, 10 in-lb - 1,200 ft-lb
- Fixtures can be ordered to simulate hard, med., or soft joints



ARDFA-XXXXHD
ARDIA-XXXHD

ARDFA-XXXHDS
ARDIA-XXXHDS

ARDFA-XXXHDE
ARDIA-XXXHDE

ARDFA-XXX
ARDIA-XXX

Wear-Resistant Heavy Duty	X			
Heavy Duty, Fully Encapsulated		X		
Heavy Duty, Encapsulated Washers			X	
Standard (Included w/analyzer)				X
Spline Drive				
Used in Conjunction with External Transducer				
ASTIS	X	X	X	X
AISI / AISF	X	X	X	X
ARTIS	X	X	X	X

*Spline drive feature provides rundown control when testing pulse tools.

AUDITOR RUNDOWN FIXTURES



To test power tools, pneumatic or electric, consistent rotational speed must be achieved. The joint rundown fixture/simulator provides the means by which the tool motor and spindle rotates freely at the start of the test cycle and then develops torque as rotation resistance increases as fastener/joint load increases. The linearity and consistency of the joint rundown fixtures/simulators vary greatly and the tool test data is a product of the variations in these rundown fixtures. Higher quality joint rundown fixtures produce torque data with less scatter.

ARDIA MODELS

MODEL*	RECOMMENDED TORQUE RANGE		SQUARE DRIVE
	NM	IN-LB	
ARDIA-10(HD)(HDE)(HDS)	.13 - 1.13	1.0 - 10	1/4"
ARDIA-25(HD)(HDE)(HDS)	.28 - 2.8	2.5 - 25	1/4"
ARDIA-50(HD)(HDE)(HDS)	.56 - 5.6	5 - 50	1/4"
ARDIA-100(HD)(HDE)(HDS)	1.3 - 11.3	10 - 100	1/4"
ARDIA-150(HD)(HDE)(HDS)	1.7 - 16.9	15 - 150	1/4"
ARDIA-250(HD)(HDE)(HDS)	2.8 - 28.3	25 - 250	3/8"
ARDIA-350(HD)(HDE)(HDS)	4 - 40	35 - 350	3/8"
ARDIA-500(HD)(HDE)(HDS)	5.6 - 56.5	50 - 500	3/8"
ARDIA-750(HD)(HDE)(HDS)	8.5 - 84.7	75 - 750	3/8"
ARDIA-1000(HD)(HDE)(HDS)	11.3 - 113	100 - 1,000	3/8"

*Add "HD" to part numbers for wear resistant models. Add "HDS" to part numbers for fully encapsulated wear resistant models.

*Add "HDE" to part numbers for partial encapsulated wear resistant models.

ARDFA MODELS

MODEL*	RECOMMENDED TORQUE RANGE		SQUARE DRIVE
	NM	FT-LB	
ARDFA-100(HD)(HDE)(HDS)	13.6 - 136	10 - 100	1/2"
ARDFA-150(HD)(HDE)(HDS)	20.4 - 204	15 - 150	1/2"
ARDFA-250(HD)(HDE)(HDS)	34 - 340	25 - 250	1/2"
ARDFA-500(HD)(HDE)(HDS)	67.8 - 678	50 - 500	3/4"
ARDFA-600(HD)(HDE)(HDS)	81.6 - 816	60 - 600	3/4"
ARDFA-750(HD)(HDE)(HDS)	101.7 - 1,017	75 - 750	3/4"

* Add "HD" to part numbers for wear resistant models. Add "HDS" to part numbers for fully encapsulated wear resistant models.



* Add "HDE" to part numbers for partial encapsulated wear resistant models.

JOINT KITS / JOINT SIMULATORS

JOINT KITS

Joint kits are an essential accessory for accurate off-line testing of powered assembly tools.

- Represent production joint conditions off the production line
- Can be adjusted to include joint conditions specified by ISO 5393
- Allows free running of bolt before torque gradient
- Provide linear response. Repeatable 1/4" – 1" drive sizes, 28 – 1,695 Nm.

ROTARY KIT*	MODEL	DRIVE SIZE - IN
 AJKR	AJKR-28	1/4
	AJKR-135	3/8
	AJKR-271	1/2
	AJKR-1017	3/4
	AJKR-1695	1
STATIONARY KIT**	MODEL	DRIVE SIZE - IN
 AJKS	AJKS-25D	1/4
	AJKS-38D	3/8
	AJKS-50D	1/2
	AJKS-75D	3/4
	AJKS-100D	1

* AJKR for use with ARTIS external transducers.

**AJKS for use with ASTIS or ARTIS external transducers.

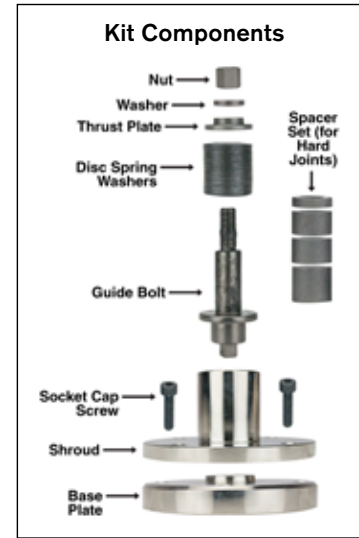

UFT SERIES HYDRAULIC MECHANICAL JOINT SIMULATORS



UFT-6

UFT-10

UFT-16



UFT-S10

UFT-S16



UFT-24

- Designed for pulse tool and continuous drive tool certification and testing, UFT Joint Simulators offer the most repeatable and linear joint rate simulation on the market
- For use with ARTIS external transducers
- Bolt tightening body and hydraulic pressure loading mechanism are connected by a hydraulic pressure circuit. Ideal for ISO 5393 test procedures
- Quickly and easily simulate three joint rates by opening or closing two external valves
- Specially coated testing bolt produces over 100,000 cycles without variation or deformation

MODEL	BOLT SIZE	TORQUE RANGE		WEIGHT	
		NM	FT-LB	LB	KG
UFT-6	M5	3.2 - 5.4	2 - 4	8	3.6
	M6	5.4 - 14.7	4 - 11		
UFT-10 / UFT-S10	M6	6.7 - 14.7	5 - 11	43	19.5
	M8	14.7 - 31.4	11 - 23		
	M10	31.4 - 53.9	23 - 40		
UFT-16 / UFT-S16	M12	53.9 - 88.2	40 - 65	88	40
	M14	88.2 - 149	65 - 110		
	M16	149 - 190	110 - 140		
UFT-24*	M18	190 - 294	140 - 217	108	49.1
	M20	294 - 441	217 - 325		
	M24	441 - 686	325 - 506		

* UFT-24 medium hard/soft joints only

Reaction fixture for continuous drive tools not included. Sockets included.

TORQUE MEASUREMENT CABLES



TORQUE MEASUREMENT CABLES

MODEL	DESCRIPTION	SERIAL CABLE	TRANSDUCER CABLE	ROTARY	ROTARY W/ANGLE	STATIONARY	IND STD	INTELLECT
ICBL-USB*	Connects between COM port of display to PC	X						
ATDBLIS*	Connect to IS transducer w/ angle - 10 pin		X		X		X	
ATDBRIS*	Connect to IS transducer - 4 pin		X	X		X	X	
ICBL-10P*	Intellect transducer cable. Identification chip in cable - 10 pin connector		X					X
ICBL-4P*	Intellect transducer cable. Identification chip in cable - 4 pin connector		X	X		X		X
ICBL-5000L	Connect from AUET/MTM & ATDA to Intellect Transducers, Analog AISI / AISF		X			X		X
ICBL-8000DIG	Connect from ATDA-8000 series analyzer to AISI / AIFI transducer		X					

* Compatible with ATDA, AUET, ADW products

TESTER / ANALYZER COMPATIBILITY

MODEL	ATC	AUET	AUET/MTM	AUET-DC	AUET/MTM-DC	ATDA	ATDA-DC	ATDA-8000	ATDA-8000-10-DCA(-TA)(-TP)	AISWT SWITCH-BOX	ADW	ADW-DC	AIMTS TEST STAND
ICBL-USB	X	X	X	X	X	X	X				X	X	
ATDBLIS		X	X	X	X	X	X						
ATDBRIS		X	X	X	X	X	X						
ICBL-10P		X	X	X	X	X	X						
ICBL-4P		X	X	X	X	X	X						
ICBL-5000L			X		X	X	X	X	X	X			X
ICBL-8000DIG								X	X				

TRANSDUCER COMPATIBILITY

MODEL	STATIONARY			ROTARY
	ASTIS	ANALOG AISI/AISF	DIGITAL AISI/AISF	ARTIS
ATDBLIS				X
ATDBRIS	X			X
ICBL-10P				X
ICBL-4P				X
ICBL-5000L		X		
ICBL-8000DIG			X	



INDEX

MODEL #	PAGE	MODEL #	PAGE	MODEL #	PAGE	MODEL #	PAGE	MODEL #	PAGE
A - B									
ADW-0010K	21	APTH-12OE10	24	ARDFA-100(HD)(HDE)(HDS)	31	ATDA	12	CPSJP73	26
ADW-0075K	21	APTH-12OE11	24	ARDFA-150(HD)(HDE)(HDS)	31	ATDA-8000	13	CPSJP75	26
ADW-0180K	21	APTH-12OE12	24	ARDFA-250(HD)(HDE)(HDS)	31	ATDA-8000-10-DCA(-TA)(-TP)	13	CPSJP81	26
ADW-0270K	21	APTH-12OE13	24	ARDFA-500(HD)(HDE)(HDS)	31	ATDA-DC	12	CPSKR81	26
ADW-0500K	21	APTH-12OE14	24	ARDFA-600(HD)(HDE)(HDS)	31	ATDBLIS	33	CPSKS00	25
ADW-1400F	21	APTH-12OE15	24	ARDFA-750(HD)(HDE)(HDS)	31	ATDBRIS	33	CPSKS50	26
ADW-DS	21	APTH-12OE16	24	ARDIA-10(HD)(HDE)(HDS)	31	ATW-0100F	23	CPSKS81	26
AHBTS-2500	19	APTH-12OE17	24	ARDIA-25(HD)(HDE)(HDS)	31	ATW-0200F	23	CPSKS82	26
AHBTS-5000	19	APTH-12OE18	24	ARDIA-50(HD)(HDE)(HDS)	31	ATW-0500F	23	CPSKS85	26
AHCTS-0.5K	16	APTH-12OE19	24	ARDIA-100(HD)(HDE)(HDS)	31	ATW-1000F	23	CPSKS86	26
AHCTS-1.5RDF	15	APTH-12OE20	24	ARDIA-150(HD)(HDE)(HDS)	31	ATWL-250	20	CPSKS87	26
AHCTS-001K	16	APTH-12RT25	24	ARDIA-250(HD)(HDE)(HDS)	31	ATWL-750	20	CPSKS88	26
AHCTS-1RDF	15	APTH-12RT38	24	ARDIA-350(HD)(HDE)(HDS)	31	ATWL-1000	20	CPSKT82	26
AHCTS-2.5K	16	APTH-12RT50	24	ARDIA-500(HD)(HDE)(HDS)	31	Audit Manager Software	14	CPSKU00	25
AHCTS-3/4RDF	15	APTH-12SD25	24	ARDIA-750(HD)(HDE)(HDS)	31	AUET-10(-DC)	10	CPSKU50	26
AHCTS-005K	16	APTH-12SD38	24	ARDIA-1000(HD)(HDE)(HDS)	31	AUET-50(-DC)	10	CPSKV00	25
AHCTS-010K	16	APTH-12SD50	24	ARTIS-25H-2T(A)	29	AUET-0100(-DC)	10	CPSMH00	25
AHCTS-025K	16	APTH-14OE1	24	ARTIS-25H-5T(A)	29	AUET-250(-DC)	10	CPSMJ00	25
AHCTS-0500	16	APTH-14OE13	24	ARTIS-25H-20T(A)	29	AUET-500(-DC)	10	D - H	
AHCTS-0500	16	APTH-14OE14	24	ARTIS-255-10T(A)	29	AUET-1000(-DC)	10	DATAPRO + SQNET Software 28	
AHCTS-2500	16	APTH-14OE15	24	ARTIS-385-75T(A)	29	AUET-1200(-DC)	10	I - L	
AHCTS-5000	16	APTH-14OE16	24	ARTIS-505-180T(A)	29	AUET-1800(-DC)	10	ICBL-4P	33
AHCTS-7500	16	APTH-14OE17	24	ARTIS-755-250T(A)	29	AUET/MTM-10-100(-DC)	10	ICBL-10P	33
AHCTS-5000	16	APTH-14OE18	24	ARTIS-755-500T(A)	29	AUET/MTM-050-25	10	ICBL-5000L	33
AHCTS-5000	16	APTH-14OE19	24	ARTIS-1005-1400T(A)	29	AUET/MTM-50-250(-DC)	10	ICBL-8000DIG	33
AHCTS-5000	16	APTH-14OE21	24	ARTIS-25H-10T(A)	29	AUET/MTM-50-500(-DC)	10	ICBL-USB	33
AHCTS-5000	16	APTH-14OE22	24	ARTIS-255-20T(A)	29	AUET/MTM-050-600(-DC)	10	iTVC	27
AHCTS-5000	16	APTH-14OE24	24	ARTIS-385-25T(A)	29	AUET/MTM-50-1000(-DC)	10	M - S	
AHCTS-5000	16	APTH-14OE25	24	ARTIS-1005-750T(A)	29	AUET/MTM-0100-050(-DC)	10	Moment Alpha 25	
AHCTS-5000	16	APTH-14OE27	24	ASTIS-25D-11	30	AUET/MTM-100-500(-DC)	10	T	
AHCTS-5000	16	APTH-14OE30	24	ASTIS-25D-28	30	AUET/MTM-100-1000(-DC)	10	Tool Manager Software 14	
AHCTS-5000	16	APTH-14OE32	24	ASTIS-38D-135	30	AUET/MTM-100-1200(-DC)	10	U - Z	
AHCTS-5000	16	APTH-14OE34	24	ASTIS-50D-270	30	AUET/MTM-100-1600(-DC)	10	UFT-6	32
AHCTS-5000	16	APTH-14OE36	24	ASTIS-75D-1000	30	AUET/MTM-100-2000(-DC)	10	UFT-10	32
AHCTS-5000	16	APTH-14OE38	24	ASTIS-100D-1700	30	AUET/MTM-250-1600(-DC)	10	UFT-16	32
AHCTS-5000	16	APTH-14OE41	24	ASTIS-100S-3000	30	AUET/MTM-250-1800(-DC)	10	UFT-24	32
AHCTS-5000	16	APTH-14OE118	24	ATC-10	9	AUET/MTM-250-2500(-DC)	10	UFT-24	32
AHCTS-5000	16	APTH-14OE138	24	ATC-25	9	AUET/MTM-500-2500(-DC)	10	UFT-510	32
AHCTS-5000	16	APTH-14RT34	24	ATC-100	9	C		UFT-S16	32
AHCTS-5000	16	APTH-14RT50	24	ATC-150F	9	CA150108DHD	15		
AHCTS-5000	16	APTH-14SD50	24	ATC-250	9	CA1510	15		
AHCTS-5000	16	APTW-25	24	ATC-250F	9	CA1550	15		
AHCTS-5000	16	APTW-50	24	ATC-500	9	CA1575	15		
AHCTS-5000	16	APTW-100	24	ATC-500F	9	CA2510I	15		
AHCTS-5000	16	APTW-150	24	ATC-750	9	CA2510I	15		
AHCTS-5000	16	APTW-200	24	ATC-750F	9	CA2515I	15		
AHCTS-5000	16	APTW-340	24	ATC-1800	9	CA2575I	15		

AIMCO CORPORATE HEADQUARTERS

10000 SE Pine Street
Portland, Oregon 97216
Phone: (503) 254-6600
Toll Free: 1-800-852-1368

AIMCO CORPORATION DE MEXICO SA DE CV

Ave. Cristobal Colon 14529
Chihuahua, Chihuahua. 31125
Phone: (01-614) 380-1010
Fax: (01-614) 380-1019

AIMCO EUROPE

Dibao Plaza Avenida Río Gallo, 431
19174 Galápagos - Guadalajara
Spain
Phone: +34 673 34 99 25

AIMCO CHINA

Room 607, No. 3998 Hongxin Rd
Minhang District, Shanghai
China
Phone: 0086-21-34319246
Fax: 0086-21-34319245

AIMCO SOUTH AMERICA

Calle Congreve No 800. Escobar
El Aromo. L207
Provincia de Buenos Aires
Argentina
CP: 1625
Phone: +54 9 11 3341 0543

AIMCO SOUTH KOREA

B-1213, 167, Songpa-Daero
Songpa-Gu, Seoul 05800
South Korea
Phone: 0082-2-2054-8930
Cell: 0082-10-9804-8905

