



Gen IV iCC Controller Operation Manual



Table of Contents

1. Safety Information	3	4.7.3 Live Tool Features	29
2. Controller Diagram	4	4.7.4 Tool Communications	30
2.1 Bottom Panel	4	4.7.5 Identify Controller	30
2.2 Front Console LED Display	4	4.7.6 Record Logs	30
3. Initial Setup	5	4.7.6.1 Change Log	30
3.1 Connecting to the Controller	5	4.7.6.2 Information Log	30
3.2 Quick Setup (Default PSets from Tool)	7	4.7.6.3 Error Log	30
4. Home Page (Main Menu)	8	4.7.6.4 All	30
4.1 Run	8	4.7.7 System Status	30
4.2 PSet	10	4.7.8 I/O Diagnostics	31
4.2.1 Add New PSet	10	4.7.9 Network Diagnostics	31
4.2.1.1 Advanced Options:	10	4.7.10 Serial Port Diagnostics	31
4.2.1.2 Add New Stage	11	4.7.11 Statistics	31
4.2.1.2.1 Stage Type	11	4.8 Login	32
4.2.1.2.2 Stage Setting Definitions	11	4.9 Advanced	32
4.2.1.2.3 Motor Setting Guidelines	12	4.9.1 Login Setup	32
4.2.1.2.4 Guidelines for PSets with		4.9.2 Results Archive	32
Two Stages	12	4.9.3 Import Settings	33
4.2.2 Tool Capabilities	13	4.9.4 Export Controller	33
4.2.3 Edit PSet	13	4.9.5 Update Controller	33
4.2.4 Default Psets	14	4.9.6 Backup Restore	34
4.2.5 Manage PSets	14	4.9.7 Restore Factory Defaults	34
4.2.6 Multistage Rundown Evaluation and		4.9.8 Previous Software	35
Reporting	14	4.9.9 Calibrate Touch Screen	35
4.3 Job	15	4.9.10 Soft Reboot	35
4.3.1 Add New Job	15	5. Barcode Reader Details	36
4.3.2 Advanced Options	15	6. Icons Defined	38
4.3.3 Jobs "Enabled" Display and Button		7. Stop Codes	39
Function	16	8. Error Codes	40
4.4 Results	16	9. 24 Volt I/O	41
4.4.1 Saving Rundown(s)	17	10. Assignable I/O	43
4.5 Controller	18	10.1 Inputs	43
4.5.1 Tool Setup	18	10.1.1 Polarity	44
4.5.1.1 Tool Parameters	18	10.1.2 Width and Offset	44
4.5.1.2 Disassembly	19	10.1.3 Input Assignments	44
4.5.2 IO	20	10.2 Outputs	48
4.5.2.1 Physical IO	20	10.2.1 Polarity	49
4.5.2.2 Physical IO Monitor	20	10.2.2 Mode	49
4.5.2.3 Anybus/Modbus TCP/Ethernet IP		10.2.3 Output Assignments	50
Inputs	21	11. Controller Supported MIDs	55
4.5.2.4 Anybus/Modbus TCP/Ethernet IP		12. Dimensions	56
Outputs	22	13. Specifications	56
4.5.3 Communication Interfaces	23	14. Troubleshooting	57
4.5.3.1 Ethernet/Second Ethernet	23	15. AIMCO Warranty	58
4.5.3.2 System Port	23		
4.5.3.3 Serial Port	23		
4.5.3.4 Anybus	24		
4.5.3.5 Spindle USB Port	24		
4.5.3.6 Serial USB	24		
4.5.4 Protocols	26		
4.5.5 Front Panel Buttons	26		
4.5.6 Power Up	26		
4.5.7 Bar Code Setup	26		
4.5.8 Set Time	27		
4.5.9 Remote Connections	27		
4.5.10 Languages	27		
4.6 Accessories	28		
4.7 Diagnostics	28		
4.7.1 Controller Overview	29		
4.7.2 Controller Status	29		

1. Safety Information

General Power Tool Safety Warnings



WARNING

Read all safety warnings, instructions, illustrations, and specifications provided with this power tool. Failure to follow all instructions listed below may result in electric shock, fire, and/or serious injury.

Save all warnings and instructions for future reference.

1. Work area safety

- a. Keep work area clean and well lit.
- b. Do not operate power tools in explosive atmospheres, such as in the presence of flammable liquids, gases, or dust.
- c. Keep children and bystanders away while operating a power tool.

2. Electrical safety

- a. Power tool plugs must match the outlet. Never modify the plug in any way. Do not use any adapter plugs with earthed (grounded) power tools.
- b. Avoid body contact with earthed or grounded surfaces, such as pipes, radiators, ranges, and refrigerators.
- c. Do not expose power tools to rain or wet conditions.
- d. Do not abuse the cord. Never use the cord for carrying, pulling, or unplugging the power tool. Keep cord away from heat, oil, sharp edges, or moving parts.
- e. When operating a power tool outdoors, use an extension cord suitable for outdoor use.
- f. If operating a power tool in a damp location is unavoidable, use a residual current device (RCD) protected supply.

3. Personal safety

- a. Stay alert, watch what you are doing, and use common sense when operating a power tool. Do not use a power tool while you are tired or under the influence of drugs, alcohol, or medication.
- b. Use personal protective equipment. Always wear eye protection.
- c. Prevent unintentional starting. Ensure the switch is in the off-position before connecting to power source and/or battery pack, picking up or carrying the tool.
- d. Remove any adjusting key or wrench before turning the power tool on.
- e. Do not overreach. Keep proper footing and balance at all times.
- f. Dress properly. Do not wear loose clothing or jewelry. Keep your hair, clothing, and gloves away from moving parts.
- g. Do not let familiarity gained from frequent use of tools allow you to become complacent and ignore tool safety principles. A careless action can cause severe injury within a fraction of a second.

4. Power tool use and care

- a. Do not force the power tool. Use the correct power tool for your application.
- b. Do not use the power tool if the switch does not turn it on and off.
- c. Disconnect the plug from the power source and/or remove the battery pack, if detachable, from the power tool before making any adjustments, changing accessories, or storing power tools. Such preventive safety measures reduce the risk of starting the power tool accidentally.
- d. Store idle power tools out of the reach of children and do not allow persons unfamiliar with the power tool or these instructions to operate the power tool. Power tools are dangerous in the hands of untrained users.
- e. Maintain power tools and accessories. Check for misalignment or binding of moving parts, breakage of parts, and any other condition that may affect the power tool's operation. If damaged, have the power tool repaired before use. Many accidents are caused by poorly maintained power tools.
- f. Use the power tool, accessories, and tool bits, etc., in accordance with these instructions, taking into account the working conditions and the work to be performed. Use of the power tool for operations different from those intended could result in a hazardous situation.
- g. Keep handles and grasping surfaces dry, clean, and free from oil and grease. Slippery handles and grasping surfaces do not allow for safe handling and control of the tool in unexpected situations.

5. Service

- a. Have your power tool serviced by a qualified repair person using only identical replacement parts. This will ensure that the safety of the power tool is maintained.

6. Equipment Installation, Operation, and Maintenance

- a. Safety of any system incorporating the equipment is the responsibility of the system assembler
- b. Position the equipment so that it is easy to access the disconnecting device
- c. Do not replace main power cord with an inadequately rated cord
- d. Only allow your power tool to be repaired by a qualified technician using only original spare parts, available from AIMCO. This ensures that the safety of your device is maintained.

2. Controller Diagram

2.1 Bottom Panel

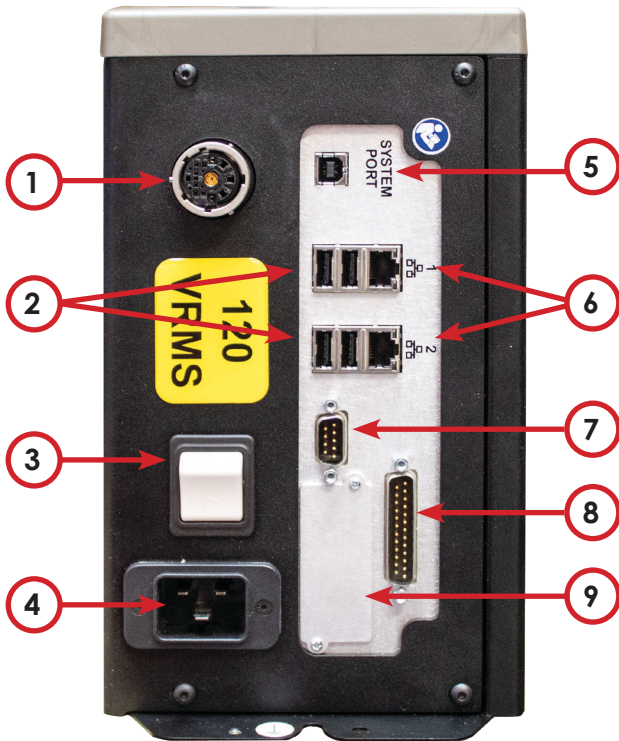

1	Tool Connection
2	USB port-for import/export of data including firmware updates
3	Power Cord Connection
4	Power Disconnect Switch-Turns controller on and off.
5	System Port- USB connection used to connect external computer to configure/monitor the controller.
6	Ethernet Port RJ45: Connection used to connect external computer to configure/ monitor the controller.
7	Serial Port (DB-9 Pin M) Serial data Output for communication with peripherals such as barcode readers and printers
8	24 Volt I/O Connector (DB-25 Pin M): Input and output of signals for process control.
9	Anybus-To connect to customer's fieldbus network (Ex: Profibus)

2.2 Front Console LED Display

Indicator Lights

Green	Indicates fastening cycle meets specified parameters.
Red	Indicates fastening cycle rejected for exceeding high torque.
Red Flashing	Indicates low torque. Fastening cycle was rejected for not achieving low torque.
Yellow	Indicates High Pulse. Fastening cycle was rejected for exceeding high pulse.
Yellow Flashing	Indicates Low Pulse. Fastening cycle was rejected for not achieving low pulse.
Blue	Tool is In-cycle, above threshold.



Toggle Button
Toggles what is shown in the secondary display

Parameter Settings (PSet)/Job Display

Increment/Decrement Buttons
Change PSet

Torque Display
Always displays torque value

Secondary Display
Toggle button switches secondary display between

- Units of measure
- Ethernet 1 IP address
- Ethernet 2 IP address
- USB (System Port) IP address
- Angle report

NOTE: If Jobs are enabled refer to "4.3 Job" on page 15 for Toggle Button function.

3. Initial Setup

Step 1: Connect Tool Cable to tool connection port of ICC Controller (see "2.1 Bottom Panel" on page 4) and then connect tool cable to the UCX tool.

Model	Description	Length
910-727-0	Tool cable iCC to UCX	5M
910-728-0	Tool cable iCC to UCX	10M

Step 2: Plug female end of power cable into Power Cable Connector.

Step 3: Plug male end of power cable into appropriate power source. Connection to local power should be made in consultation with a qualified electrician.

Step 4: The Redundant Earth Ground (required) must be connected to ground using the #14 AWG conductor, a green wire with a yellow stripe. Attach using a #10-14AWG ring terminal and #10 star washer (see Figure 1).



Figure 1 — Redundant Earth Ground Attachment

Step 5: Turn controller on by pushing the Power Disconnect Switch to the POWER ON position, a light indicates power on.

3.1 Connecting to the Controller

There are three ways to program/communicate with the controller:

- Controller touch-screen console
- System Port: (USB A to B connection) Direct connection to controller.
- Ethernet Port: Via direct connection or LAN.

Touchscreen Console

Controller functions and programming can be accessed directly through the touch-screen.

1. Power on controller.
2. Run screen will appear
3. Controller is ready for use.

Connecting via the System Port Directly to PC

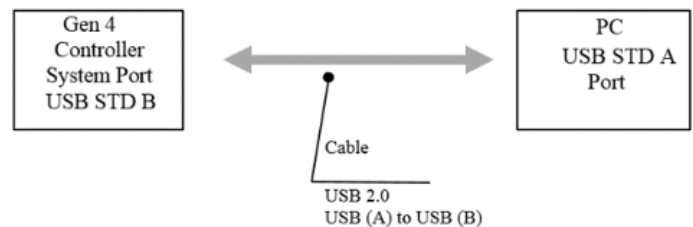

The following is an example using Window 7. Your screen may look different depending on the operating system.

Windows USB Setup

Step 1: Power on PC and controller, allow enough time for them to become fully operational.

Step 2: Attach controller to PC using a USB 2.0 A-B cable. If this is the first time connecting the devices, wait for Windows to install the RNDIS driver. This should happen automatically.

Step 3: After the driver is installed, go to 'Control Panel'.

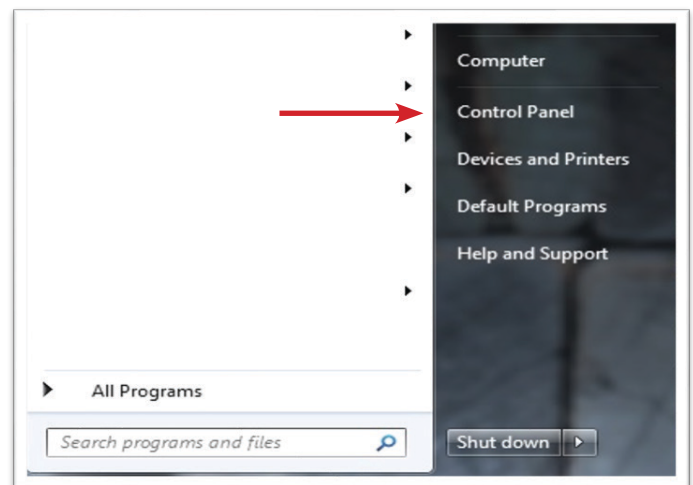

Step 4: Go to 'Network and Internet'.

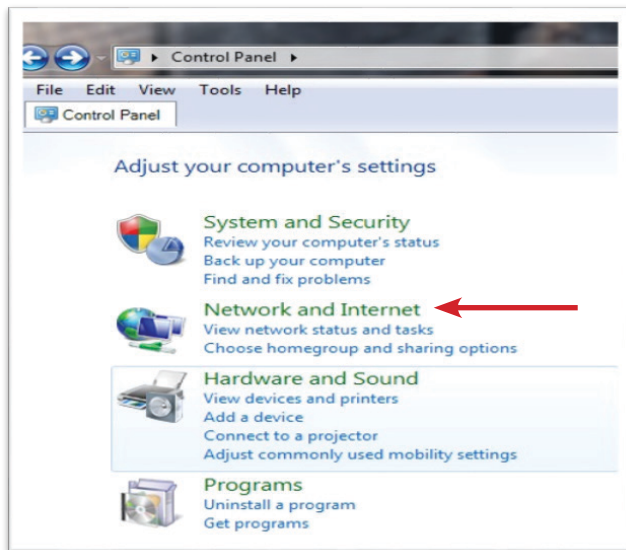

Step 5: Go to 'Network and Sharing Center'.

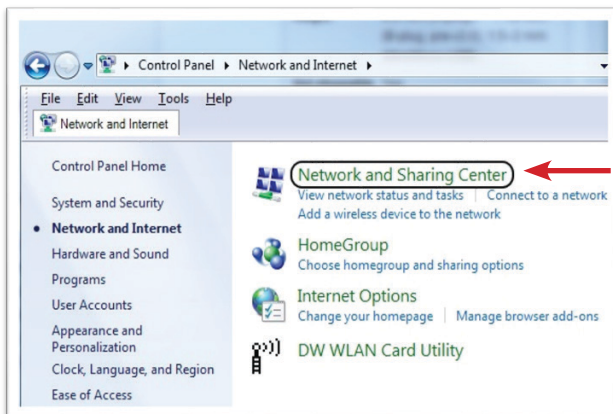

Step 6: Go to 'Change adapter settings'.

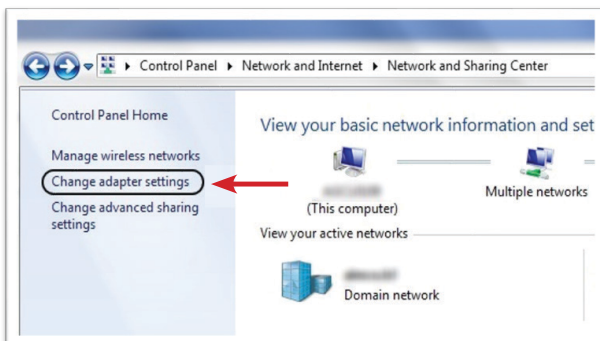

Step 7: Find the Local Area Connection that is using the 'USB Ethernet/RNDIS Gadget' network. Right click this network and go to 'Properties'.

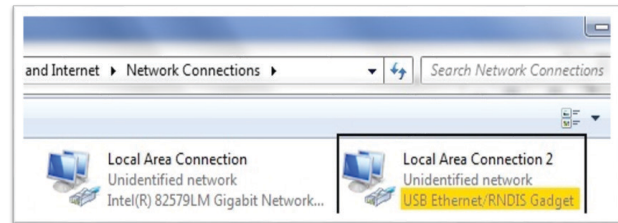

Step 8: In Properties window select 'Internet Protocol Version 4' and click 'Properties'.

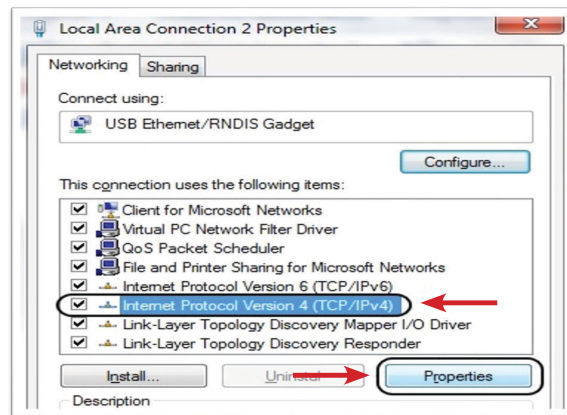

Step 9: In 'Properties', set the IP address to a static address.

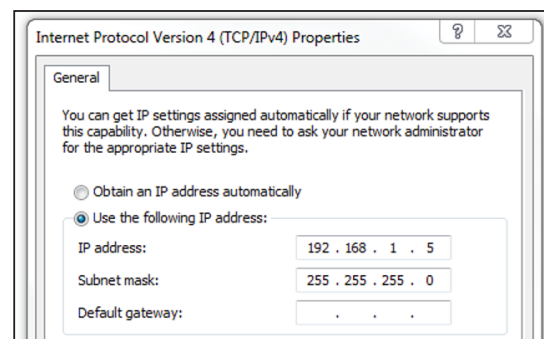

Type an IP address of 192.168.1.5 (Any address on the same subnet as the controller will work). Set subnet mask to 255.255.255.0

Step 10: To connect to the controller, open a browser such as Chrome or Firefox. Enter 192.168.1.4, the default system port IP address.

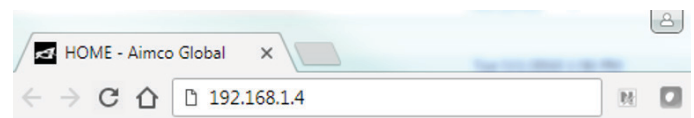

You will see the controller software on your computer screen.



NOTE: Controller does not have a DHCP client, it will not automatically configure itself with a usable IP address. Consult your Network Administrator for configuring a correct IP address for your network. The PC, Laptop or Tablet IP address will need to be configured to communicate with the controller.

Connecting using the Ethernet Port Directly or via LAN to PC

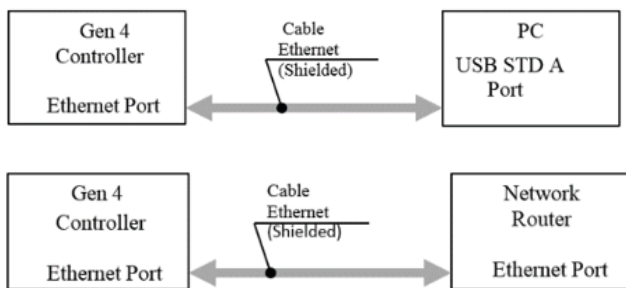

Turn on the computer and make a physical connection by using a straight through Ethernet cable.

Turn on controller. Verify the controller IP address in 'Communication Interfaces' or press toggle button to verify the IP address. If defaulted 0.0.0.0 set desired IP address.

Set a static IP address of the Computer/Laptop to 10.10.30.98 (example) and subnet mask to 255.255.255.0. (For instructions, see the example in "Step 9" earlier in this section.)

To connect to the controller. In the Computer/Laptop open a browser such as Chrome or Firefox. Enter 10.10.30.99, the default Ethernet port IP address.

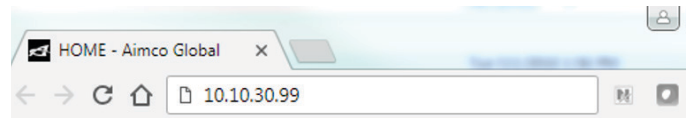

You will see on your computer screen the controller software

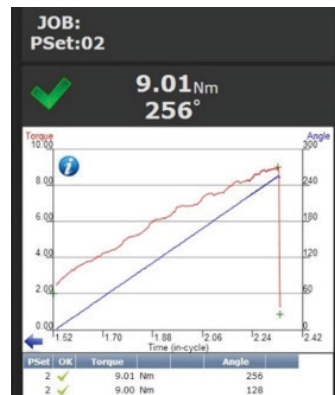

NOTE: Controller does not have a DHCP client, it will not automatically configure itself with a usable IP address. Consult your Network Administrator for configuring a correct IP address for your network. The PC, Laptop or Tablet IP address will need to be configured to communicate with the controller.

3.2 Quick Setup (Default PSets from Tool)

On the Home Page press the following to accept default PSet Parameters:

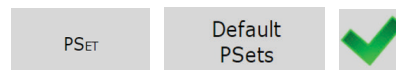

This will generate three generic PSets for the tool connected to the controller. It will automatically use the 40%, 60%, and 80% of the rated maximum torque set in Controller/Tool Setup/Tool Parameters to create a two-stage Torque Control Pulse Monitor Strategy (TC_PM) PSets. A prompt will display rated Max Torque and Max RPM of the connected tool for reference. These PSets can be modified to meet application requirements.

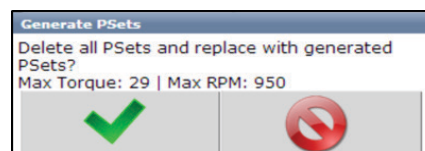

4. Home Page (Main Menu)



4.1 Run

The Run Screen is essentially the dashboard of the Gen IV controller and provides a look at real-time information regarding rundowns.

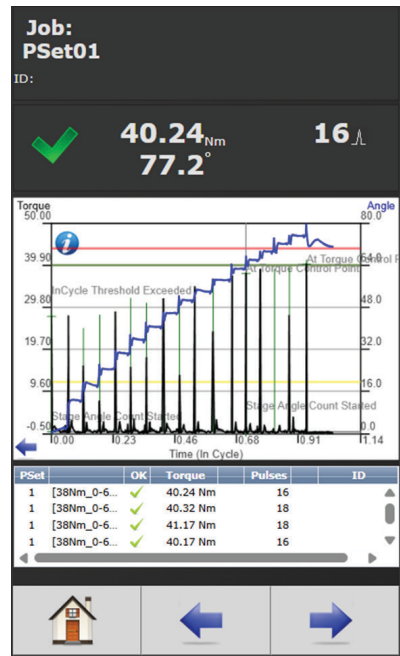

Time (In-Cycle) Screen

JOB:	Indicates the current JOB.
PSet:01	Indicates the current PSet in which you are operating.
	Indicates accepted rundown.
	Indicates failed rundown.
40.24_{Nm}	Displays Torque and Angle for current rundown
16	Number of Pulses
77.2°	Angle Count

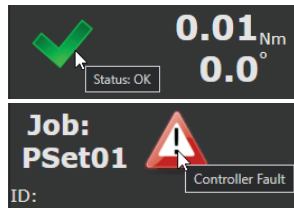

Click on (or remote sessions can hover over) the rundown status icon or stop icons for a text description.

Graph displays curves representing Torque (green trace). The blue left arrow at the origin of the graph will change the X-axis of the rundown curve from Time (In - Cycle) to Time (Overall) and Angle.

Below the graph is a historical table that will give information and status of the most recent rundowns, including current PSet, accepted/failed rundown status, torque and angle.



Arrows allow user to scroll left or right for viewing real time Job information such as Run Screen or rundown indicators.

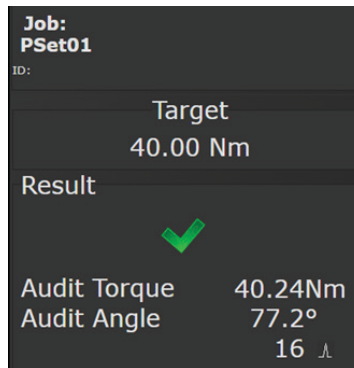

Home tab will return user to the Home Page

On the Run Screen, click for curve detail.

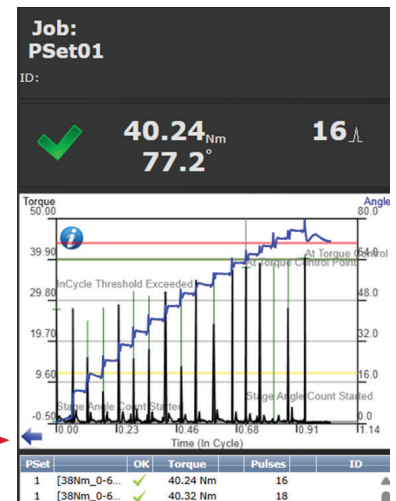

Click on blue arrow to change curve X axis.

Choose Time In-cycle or Time Overall screen.

Large Screen Indicators and Audit information

The large screen indicators are helpful in viewing real time results of the rundown from a distance.

Example of Good Rundown

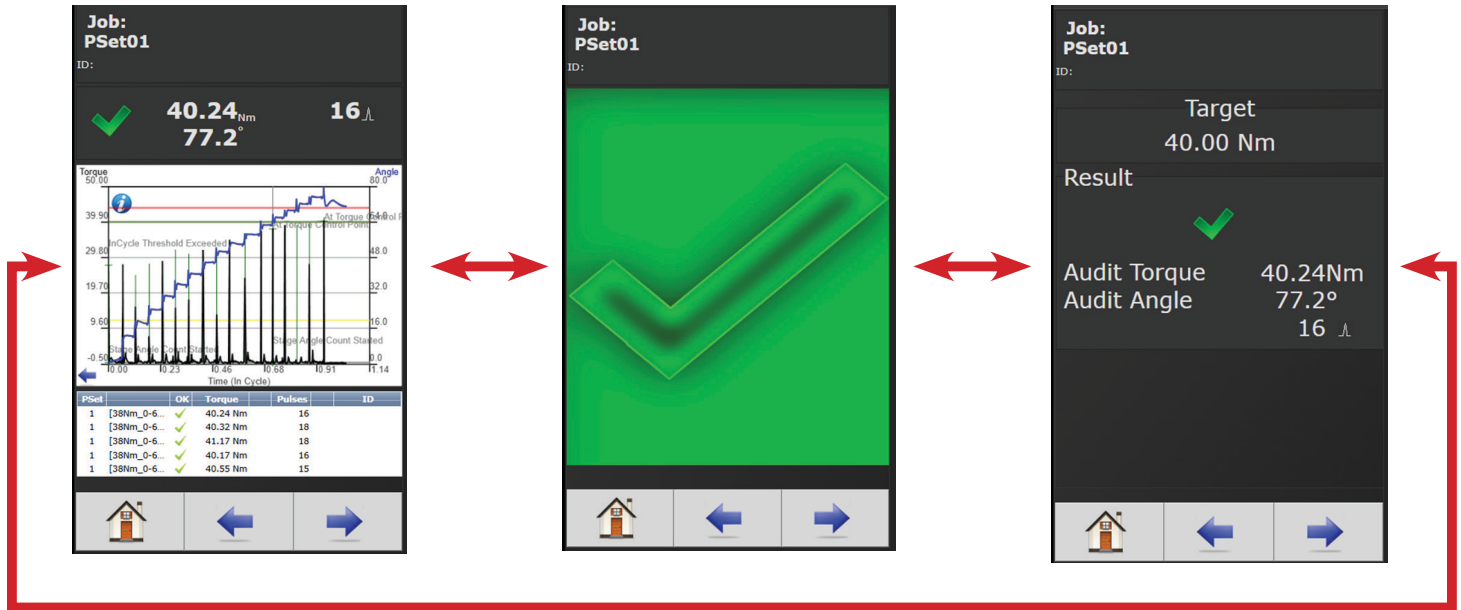

Example of NOK Rundown

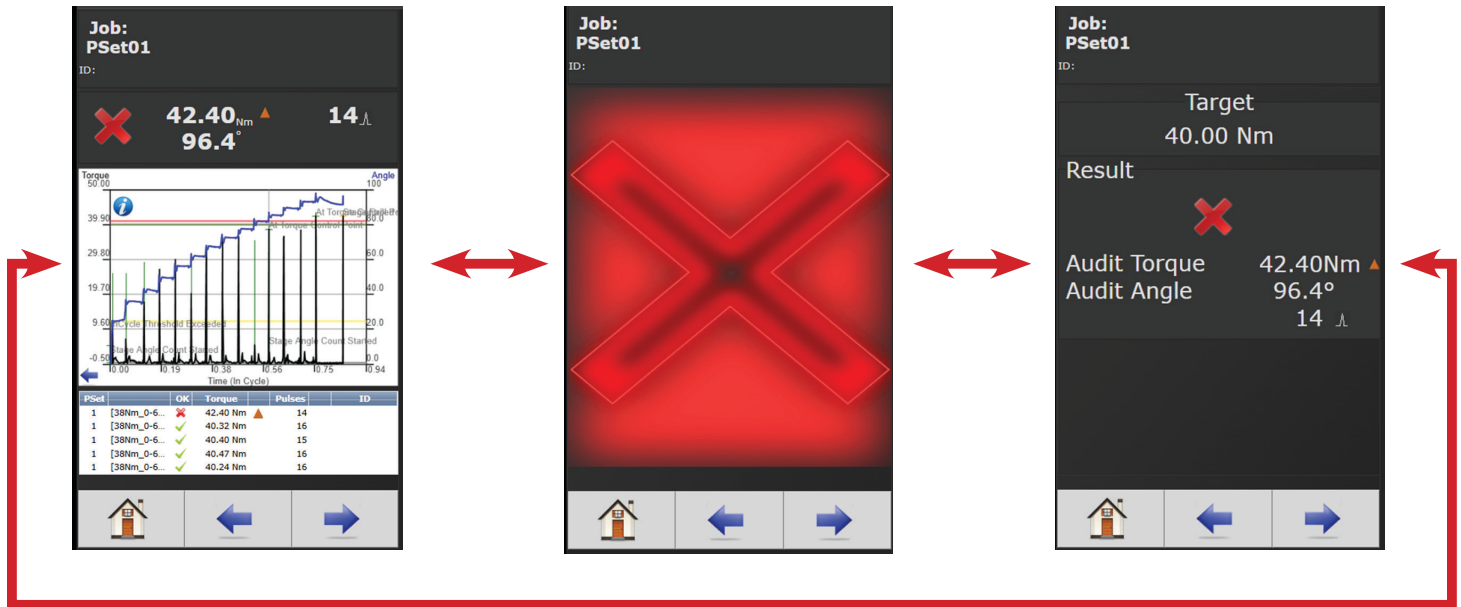

4.2 PSet

Parameter Settings (PSETS) control the fastening process. The following describes the different fastening strategies and how to setup the basic PSet parameters necessary to perform a fastening. Up to 256 PSETS are available.

4.2.1 Add New PSet

On Home Page press the  PSET tab.

On PSETS screen press  to add a new PSet.

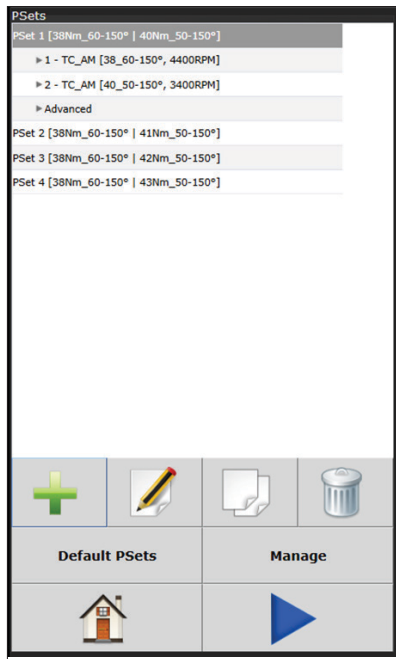

 Add a PSet

 Edit a PSet

 Copy a PSet

 Delete a PSet

Default PSETS: See "3.2 Quick Setup" on page 7.

Manage: See "4.2.5 Manage PSETS" on page 14.

On PSet Edit Screen and Advanced Options Screen (following) enter appropriate values.

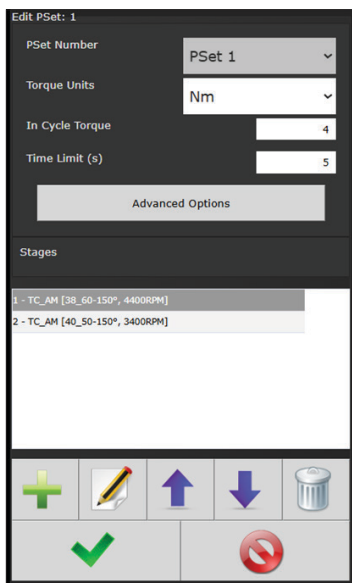

PSet Number: Current PSet to be added/edited.

Torque Units: Unit of torque measurement and reporting of the fastening cycle.

In Cycle Torque: Threshold value at which tool is "In Cycle" and results from the Rundown will be reported.

Time Limit(s): Maximum time the tool (in seconds) the tool is

allowed to run after In Cycle Torque is reached.

4.2.1.1 Advanced Options:

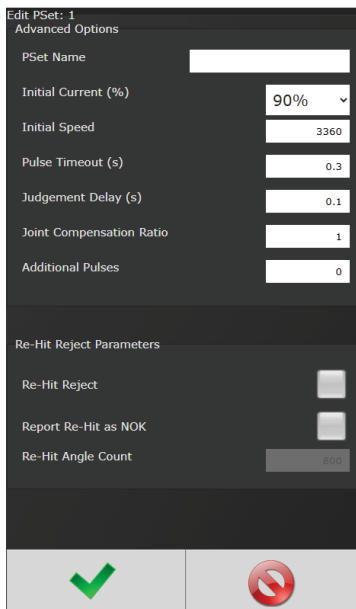

PSet Name: Add PSet name if desired (up to 10 characters).

Initial Current (%): Maximum allowable current supplied to the motor before In Cycle is reached.

Initial Speed: The target speed in RPMs of the tool before In Cycle is reached.

Pulse Timeout: After going In Cycle, if the time between pulses is greater than this time, the tool stops and fastening is ended.

Judgement Delay (s): Time delay after fastening has ended, where the rundown is still being monitored, after which the rundown is evaluated and reported.

Joint Compensation Ratio: Adjusts the calibration of the tool to compensate for the application's joint characteristics. The 'Total Torque Calibration Ratio' = CAL * CAL Ratio * Joint Compensation Ratio. Total Torque Calibration Ratio values above 1.0 result in a lower output torque where values below 1.0 result in higher output torques.

Additional Pulses: After reaching the target, additional pulses to be applied before shutting off the tool.

Re-Hit/Reject Parameters: Prevents the fastening of an already tightened fastener. If enabled, tool will stop and the rundown will be aborted if the angle of rotation (between 40 mSec before In-Cycle and when In-Cycle torque threshold has been reached) is less than the Re-Hit Angle Count.



- **Re-Hit Reject Enable:** Enables this feature
- **Report Re-Hit as NOK:** If checked, Re-Hit will be reported as NOK with torque, angle, and pulse reported as LOW. If not checked, the tool will be shut off and the controller will not go into cycle.

- **Re-Hit Angle Count:** If the angle changes less than this count (between 40 mSec before In-Cycle and when In-Cycle torque threshold has been reached) it is determined to be a Re-Hit.

Once PSet values are entered press  to enter Edit Stage screen (shown in the following section).

4.2.1.2 Add New Stage

You can add one or two stages to a PSet. Once the desired stage(s) are selected and configured, press  to save stage and again to save the PSet and return to initial PSet menu.

Next Press  to go to the RUN screen or  to return to the Home page. The tool should now be operational and you are ready to run a configured PSet.

4.2.1.2.1 Stage Type

Choose from four fastening strategies:

- TC: Torque Control

- TC_PM: Torque Control Pulse Monitor

- TC_AM: Torque Control Angle Monitor

- AC_TM: Angle Control Torque Monitor

4.2.1.2.2 Stage Setting Definitions

- **Torque Bailout:** The tool will stop if this torque is exceeded. The Torque Bailout value should be equal or greater than High Torque.
- **Torque High:** Upper control limit of the rundown.
- **Torque Target:** Final desired torque (CUT Level).
- **Torque Low:** Lower control limit of the rundown.

- **Pulse Bailout:** Total number of pulses never to be exceeded. Helps to illustrate how far past Pulse High the rundown experienced without damaging the part or excessively wearing the tool's pulse fluid.
- **Pulse High:** Maximum acceptable pulses.
- **Pulse Low:** Minimum acceptable pulses
- **Pulse Reference:**
 - In-cycle Pulse: Monitoring the number of tool Pulses begins after the tool goes 'In Cycle'.
 - Stage Pulse: Monitoring pulses specifically in the Stage
- **Angle Bailout:** Determines when to stop the tool on angle during any Torque Control strategy. Should be set equal to or above High Angle. Units are degrees of rotation of the tool's output.
- **Angle High:** Maximum acceptable angle rotation in degrees.
- **Angle Target:** Final desired output rotation in degrees
- **Angle Low:** Minimum acceptable angle rotation in degrees.
- **Angle Reference:**
 - In-cycle Angle: Monitoring the degrees of angle begins after the tool goes 'In Cycle'.
 - Stage Angle: Monitoring angle specifically in the Stage.
- **Angle Reference Torque:** Monitor the degrees of stage angle starting from the reference torque value set.
- **Motor Speed (RPM):** The target speed of the tool for the stage.
- **Motor Duty Cycle (%):** Adjusts the tightening power by limiting the average voltage supplied to the tool. The value set in the first stage affects the rundown from before In Cycle to the end of the first stage. The value set on the second stage affects the second stage only.
- **Motor Current (%):** The maximum allowable current supplied to the motor during the stage.
- **Stage Timeout (s):** Maximum allowable time (in seconds) in this stage. If time is exceeded, the tool will stop and the Rundown will be terminated.

4.2.1.2.3 Motor Setting Guidelines

In general, higher Motor Speed and Motor Current settings are required for higher torque and/or softer joint rates. When setting the Motor Speed and Current, start with a Duty Cycle at 100%. Then, reduce the Duty Cycle % to fine tune the motor power.

4.2.1.2.4 Guidelines for PSets with Two Stages

- Set the target in the first stage to 60% - 98% of the desired target.
- Add a second stage set to the desired target, with reduced motor power settings to increase pulses at the end of the rundown to improve accuracy.

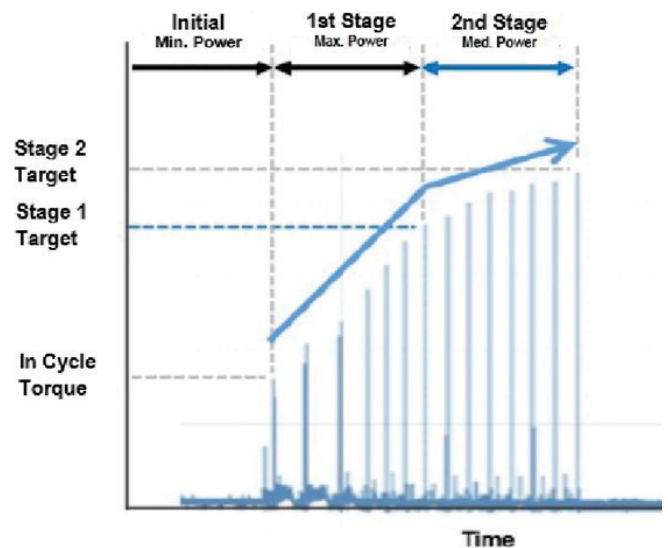

Motor Settings for PSets with Two Stages

Step	Initial (Pre-InCycle)	1st Stage	2nd Stage (Final)
Transition to Next Step	InCycle Torque Threshold reached	Stage 1 Target reached	Stage 2 Target reached
Purpose	Suppress jump during pre-tightening seating	Tighten quickly with minimal pulses until just before the target torque	Reduce variations in final tightening by suppressing final output
Power	Minimum Power	Maximum Power	Medium Power
Applicable Speed Setting	Initial Speed	Stage 1 Speed	Stage 2 Speed
Applicable Current % Setting	Initial Current	Stage 1 Current	Stage 2 Current
Applicable Duty Cycle % Setting	Stage 1 Duty Cycle	Stage 1 Duty Cycle	Stage 2 Duty Cycle

Typical Two Stage Motor Settings

Motor Power Requirements	Initial Speed (RPM)	Initial Current	Stage 1 Speed (RPM)	Stage1 Current	Stage 2 Speed (RPM)	Stage 2 Current
Low	1500	70%	1700	90%	1700	70%
Middle	2000	70%	3000	90%	2500	70%
High	2000	90%	4000	100%	3500	90%
Very High	2000	90%	4800	100%	4800	100%

4.2.2 Tool Capabilities

Model	URYU Recommended Static Torque Range (Nm)	AIMCO Recommended Max. Dynamic Torque Target (Nm)	Max. Free Speed (RPM)	Number of fasteners per minute
UCX-AF600L	4 – 20	14	4800	12
UCX-AF600	10 – 40	28	4800	10
UCX-AF700	20 – 60	42	4800	9
UCX-AF900	30 – 72	60	4800	9

4.2.3 Edit PSet

On Home page press

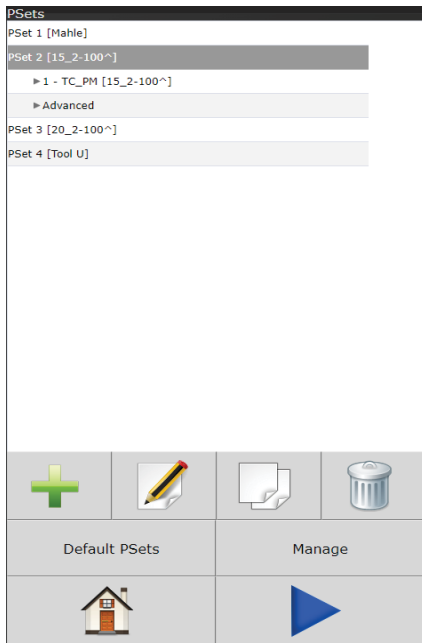
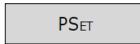

On the PSet screen click on the desired PSet you would like to edit.

Click on the Edit button to make changes in the Edit screen (below).

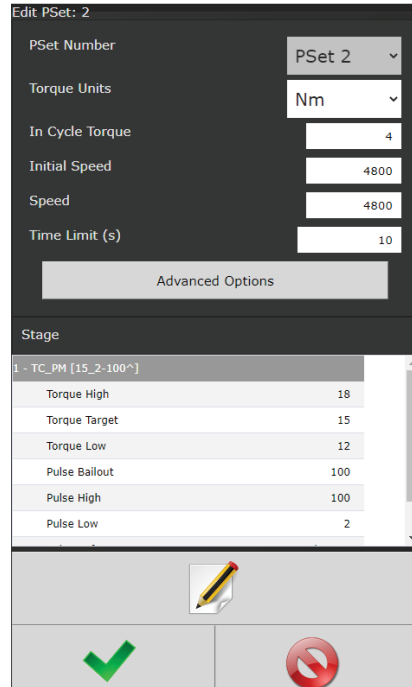

If further Stage changes are needed click the

Edit button again to enter Edit Stage screen (below).

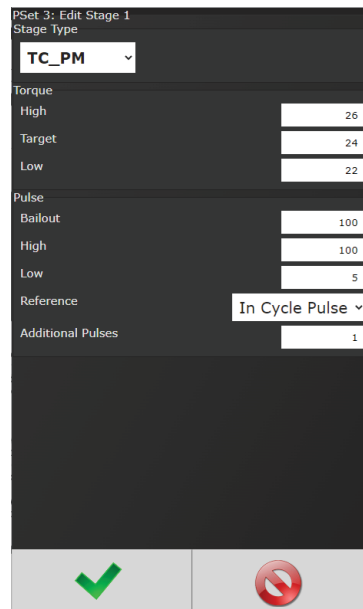

Once desired changes are made click twice to save changes.

4.2.4 Default Psets

See "3.2 Quick Setup" on page 7.

4.2.5 Manage PSets

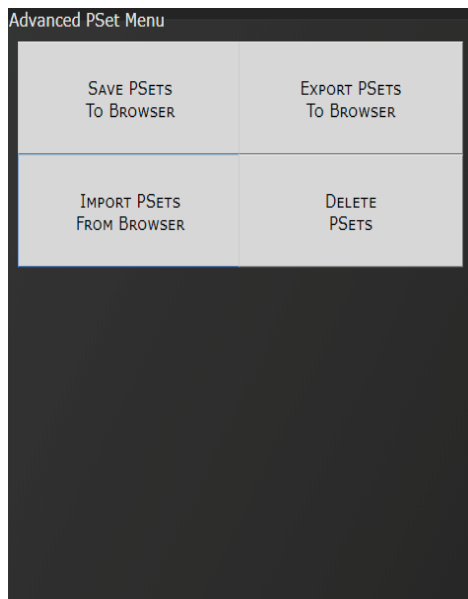

Save PSets to Browser

Allows the PSet information to be saved to the local PC connected to controller. PSet information is saved as a .txt file and can be opened using any text editor such as WordPad. It can also be opened with Excel. The format of the .txt file is tab separated values.

Export PSets to Browser

Save the PSets as a database file to the PC connected to controller. These PSets can later be imported to another controller.

Import PSets from Browser

Import previously exported PSets to controller.

Delete PSets

Enables deletion of selected PSets.

4.2.6 Multistage Rundown Evaluation and Reporting

- If a rundown cycle completes, or is terminated early while in or after the final stage of the PSet:
 - The overall evaluation of the rundown will be determined using the limits set in the final stage.
 - The peak torque, pulse count, and angle, achieved during the rundown are used for the evaluation and reported.
 - Note: The fastening torque must reach the In-Cycle torque value set in the PSet in order for the rundown to be evaluated and reported.
- If a rundown is terminated early before reaching the final audit stage:
 - The overall result of the rundown will be reported as a reject.
 - The torque, pulse, and angle evaluation will be determined using the limits set in the stage that was running when the rundown was terminated.
 - The peak torque, pulse count, and angle at the point in time when the rundown was terminated, is used for the stage evaluation.
 - The torque, pulse count, and angle status reported will reflect this stage evaluation with the following exception:
 - If torque, pulse count, and angle are all within limits of the stage that was running, the torque, pulse, and angle status will all be reported as low. This is done to further indicate that the rundown terminated before reaching the final audit stage.
 - The peak torque, pulse count, and angle achieved, during the rundown, will be reported.
- Angle measurement details:
 - Peak Angle used for overall evaluation and reported is the peak angle achieved during the rundown, measured from the angle reference set in the final stage. Note: If an angle reference is not defined in the final audit stage, the angle is measured from when the torque first crosses the In-Cycle torque set in the PSet.
 - Angle used for stage evaluation is the angle at the point in time when stage was terminated or completed, measured from the angle reference set in the stage.
- Note: If the evaluation of any stage during the rundown fails, or a bail out limit is exceeded, the fastening cycle will be terminated early and any subsequent stages will not run.

4.3 Job

A Job is a collection of PSets which can be run when performing multiple fastening operations on a single application.

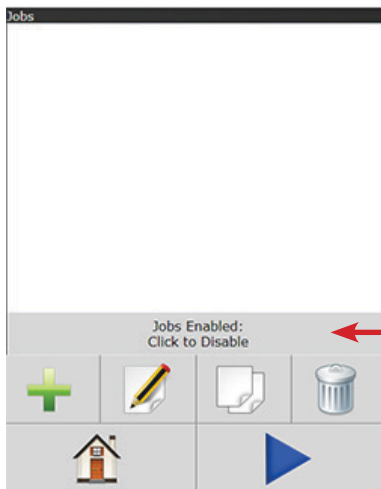

- Jobs provide:
- Error proofing
 - Logical grouping of PSets
 - Fastening order
 - Job status

Click to Enable/Disable Job function.

4.3.1 Add New Job

To add a new Job press **Job** on the Home Page. Press on Jobs screen (above) to enter Add New Job screen (below)

Job Number: Up to 99 Jobs can be configured.

Job Action:

- **Disable Tool:** Disable tool after job is finished. Job complete Icon will appear.



Tool will not operate until job is reset.

- **Reset Job:** Will reset after Job is finished. Once Reset Job is finished, the following icon appears:



This means that results from the last successful rundown of a job are cleared. Information from last successful rundown can still be accessed in the Results screen (see "4.4 Results" on page 16).

Job Name: Enter Job Name

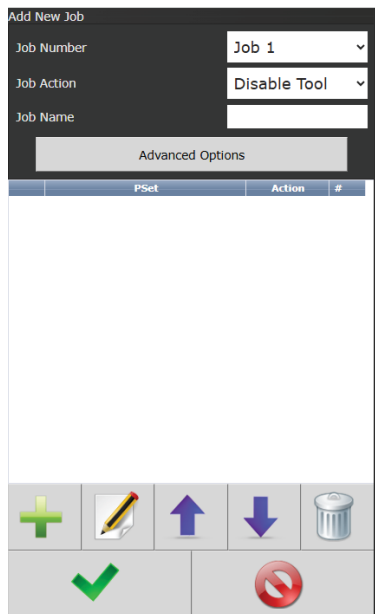

After appropriate values are entered, press to go to Add New Job Sequence screen.

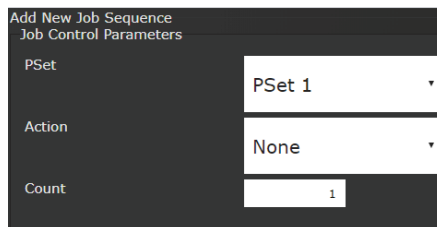

PSet Number: Choose any current PSet already configured in controller.

Action:

- **None:** Will stay in current sequence.
- **Next:** will advance to next sequence set up after count is reached.

Count: Fastener number required to complete sequence.

Once values are entered press two times to return to Job screen

4.3.2 Advanced Options

Enter Advanced Options **Advanced Options** if needed.

Lock on Reject Parameters:

- **Enable:** When enabled, this prevents tool from starting a new rundown if the result of the last rundown was a reject. The tool can be enabled with the "Remove Lock on Reject" assignable input.

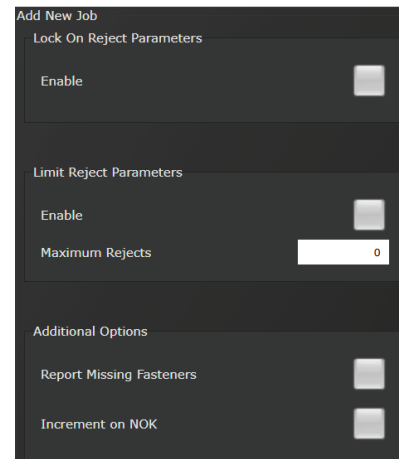

Limit Reject Parameters:

- **Enable:** Enable or Disable
- **Maximum Rejects:** Number of rejected fasteners allowed

Additional Options:

- **Report Missing Fasteners:** Add an option to each JOB that would allow us to report any missing fasteners. When it is set, the controller will report a NOK rundown for each fastener that is defined in the JOB but has not been run. These NOK results will be reported whenever a new job is started AND the prior JOB is incomplete.

These generated NOK results are treated like any other fastening. They are displayed on the run screen, stored in the results and transmitted on all protocols.

- **Increment on NOK:** If enabled, the JOB will count NOK fastening toward the bolt count to complete the JOB.

4.3.3 Jobs "Enabled" Display and Button Function

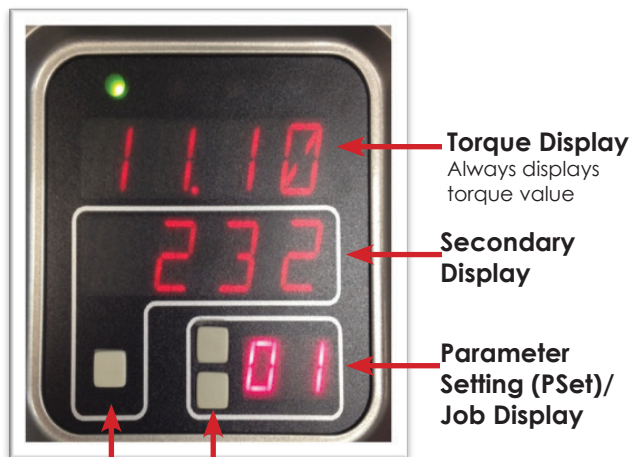

Toggle Button
PSet Job Functions

Increment/Decrement Buttons

- Increment and Decrement buttons change the job sequence. The pset number will change and job sequence number on secondary display will change if jobs are enabled.
- Holding the toggle button will display will display the Job number, while pressing increment or decrement buttons will change it. The two numbers on the PSet/Job display will be separated by decimals.
- Pressing the toggle button will change secondary display between:
 - Units of measure
 - Ethernet IP address
 - System port IP address
 - Angle report
 - Bolt count
 - Job sequence
 - Pulse count

NOTE: Job sequence shows which PSet you are currently on in the job (this is not the pset number). The first pset in the job is always job sequence 1, and the next is 2, etc.

Bolt count is shown as current bolt count out of total number of bolts. Example: If you have 3 total bolts. When you start the job you will see 0.3. After one rundown you will see 1.3 and then 2.3 on the next run and so on until the job is completed.

4.4 Results

ID	Time Stamp	PSet	OK	Torque	Pulses
10	01/01 21:36:44	4	✓	46.93 Nm	23
9	01/01 21:36:37	4	✓	46.03 Nm	26
8	01/01 00:09:27	1	✓	10.45 Nm	4
7	01/01 00:09:25	1	✓	10.61 Nm	4
6	01/01 00:09:22	1	✓	10.03 Nm	4
5	01/01 00:09:17	1	✗	12.15 Nm	3
4	01/01 00:09:14	1	✗	10.21 Nm	2
3	01/01 00:09:06	1	✗	10.70 Nm	2
2	01/01 00:09:03	1	✓	11.81 Nm	3
1	01/01 00:08:56	1	✗	5.95 Nm	1

This screen provides a history of rundowns performed. Information such as ID Number, Time Stamp, Parameter Set#, Accept /Reject status, and Torque and Angle are recorded for each rundown.

	Filter Button gives filter options in Rundown screen.																																
	Save Button saves rundowns as .Txt File.																																
	Deletes individual rundowns by clicking on them																																
	Select Columns Button lets you customize the columns shown on the Results Screen																																
	<table border="1"> <thead> <tr> <th colspan="4">Select Columns</th> </tr> </thead> <tbody> <tr> <td>Rundown ID</td> <td><input checked="" type="checkbox"/></td> <td>Timestamp</td> <td><input checked="" type="checkbox"/></td> </tr> <tr> <td>PSet</td> <td><input checked="" type="checkbox"/></td> <td>OK/NOK</td> <td><input checked="" type="checkbox"/></td> </tr> <tr> <td>Torque</td> <td><input checked="" type="checkbox"/></td> <td>Angle</td> <td><input checked="" type="checkbox"/></td> </tr> <tr> <td>Pulses</td> <td><input checked="" type="checkbox"/></td> <td>Barcode ID #1</td> <td><input type="checkbox"/></td> </tr> <tr> <td>Stopped</td> <td><input type="checkbox"/></td> <td>Barcode ID #2</td> <td><input type="checkbox"/></td> </tr> <tr> <td>Aborted</td> <td><input type="checkbox"/></td> <td>Barcode ID #3</td> <td><input type="checkbox"/></td> </tr> <tr> <td>Faulted</td> <td><input type="checkbox"/></td> <td>Barcode ID #4</td> <td><input type="checkbox"/></td> </tr> </tbody> </table>	Select Columns				Rundown ID	<input checked="" type="checkbox"/>	Timestamp	<input checked="" type="checkbox"/>	PSet	<input checked="" type="checkbox"/>	OK/NOK	<input checked="" type="checkbox"/>	Torque	<input checked="" type="checkbox"/>	Angle	<input checked="" type="checkbox"/>	Pulses	<input checked="" type="checkbox"/>	Barcode ID #1	<input type="checkbox"/>	Stopped	<input type="checkbox"/>	Barcode ID #2	<input type="checkbox"/>	Aborted	<input type="checkbox"/>	Barcode ID #3	<input type="checkbox"/>	Faulted	<input type="checkbox"/>	Barcode ID #4	<input type="checkbox"/>
Select Columns																																	
Rundown ID	<input checked="" type="checkbox"/>	Timestamp	<input checked="" type="checkbox"/>																														
PSet	<input checked="" type="checkbox"/>	OK/NOK	<input checked="" type="checkbox"/>																														
Torque	<input checked="" type="checkbox"/>	Angle	<input checked="" type="checkbox"/>																														
Pulses	<input checked="" type="checkbox"/>	Barcode ID #1	<input type="checkbox"/>																														
Stopped	<input type="checkbox"/>	Barcode ID #2	<input type="checkbox"/>																														
Aborted	<input type="checkbox"/>	Barcode ID #3	<input type="checkbox"/>																														
Faulted	<input type="checkbox"/>	Barcode ID #4	<input type="checkbox"/>																														
	Home Button returns to main display menu.																																
	Play Button sends you directly to Run Screen.																																
	Refresh Button refreshes screen to include latest rundowns.																																

ID	Time Stamp	PS...	OK	Torque	Angle
112	01-01 02:29:00	1	✓	12.03 Nm	124
111	01-01 02:28:56	1	✓	11.98 Nm	124
110	01-01 02:28:50	1	✓	12.02 Nm	112
109	01-01 02:28:46	1	✓	11.63 Nm	113
108	01-01 02:20:13	1	✗	2.56 Nm	34

Click on Individual Runs for Rundown information.

Example: Rejected Rundown Information.

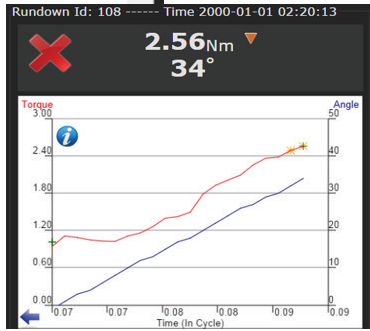

Saving Individual Rundowns

ID	Time Stamp	PS...	OK	Torque	Angle
490	01-01 01:01:28	1	✓	15.69 Nm	3
489	01-01 01:01:27	1	✓	15.33 Nm	3

To save an individual rundown, select a

rundown from the Results screen.

This opens the Rundown Information View. Click on in save the rundown. The file will automatically download as a CSV file.

Rundown Information View

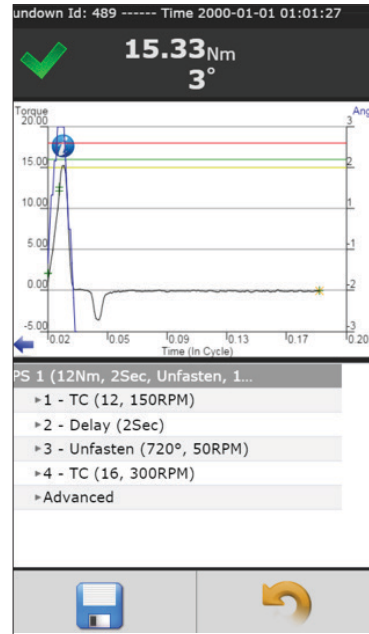

Sample of Individual Rundown Information

1	Result	65
2	Job Numb	1
3	Job Name	Paramont
4	Job Sequ	1
5	Bolt Coun	3
6	Date	##### 4:18:00
7	Master Ru	0
8	PSet ID	59
9	PSet Num	1
10	PSet Name	
11	Tool Mod	AEN32030A
12	Tool Seria	191111
13	Torque	11.69
14	Angle	57
15	Pulses	0
16	Torque St:P	
17	Angle Stat--	
18	Pulse Stat--	
19	Rundown P	
20	Tool Cycle	1111
21	ID1 ("ID #1)	2.2E+10
22	ID2 ("ID #2)	4.86E+10
23	ID3 ("ID #3")	
24	ID4 ("ID #4")	
25		
26		
27		
28	Curves	
29	Tick	Torque Angle
30	0	0.02 0
31	1	0.02 0
32	2	0.05 0
33	3	0.04 0
34	4	0.09 0

4.4.1 Saving Rundown(s)

Saving All Rundowns

Click on in main rundown screen to view/save total rundowns. A dialog box will open that allows you to choose the download format, either a CSV file or a TW4 file. The CSV file includes rundown data in tab separated variables and can be viewed using Excel or opened in text editor such as Notepad. The raw data can be imported to Excel to build graphs, charts etc. Contact AIMCO Technical Service for pre-made Torque and Angle Templates.

The TW4 file can be opened using the ACE Platform G4 Utility located on the [software page](#) of the AIMCO website.

Save Results

File Type: CSV

Include Stage Results:

Include Log Entries:

The dialog box also shows options for including stage results or log entries in the downloaded file. If downloading a TW4 file, all information will be automatically selected.

Click and your browser will download the file.

HTTP Method for Retrieving and Saving Rundown Results

An http request to the controller for file "fastening.csv" (<http://ipaddress/fastening.csv>) will return the most recent rundown in the full rundown CSV format. This is in the same format as "Home->Results" selecting a results then selecting save.

Optionally, a specific ID can be selected. An http request to the controller for file "fastening.csv" with the optional parameter "id" set to the desired id number (<http://ipaddress/fastening.csv?id=47>) will return rundown id the full rundown CSV format.

The format can also be changed with the optional "version" parameter. An http request to the controller for file "fastening.csv" with the optional

parameter "version" set to 1 (http://ipaddress/fastening.csv?version=1) will return a CSV file in the "QualityWorX File" format.

The "id" and "version" options can be used in any combination as needed.

4.5 Controller

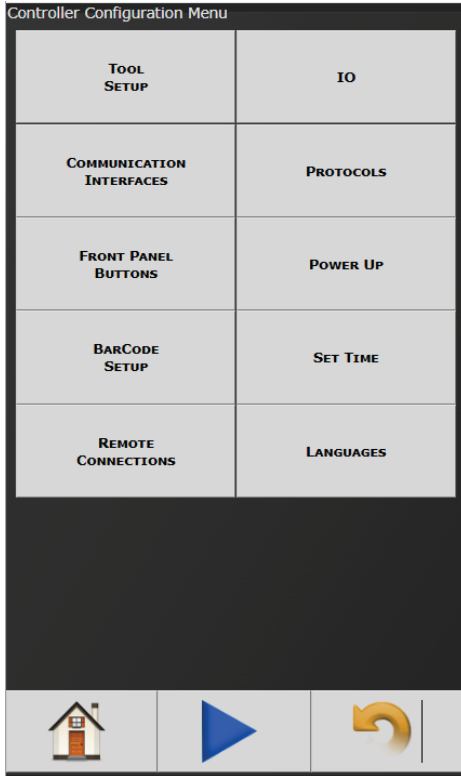

The controller menu is where all of the settings for the Gen IV controller are configured. All of the different configuration capabilities are explained below.

4.5.1 Tool Setup

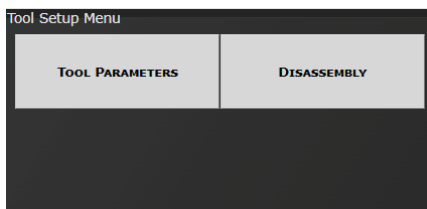

In this screen user can enable/disable various tool functions.

4.5.1.1 Tool Parameters

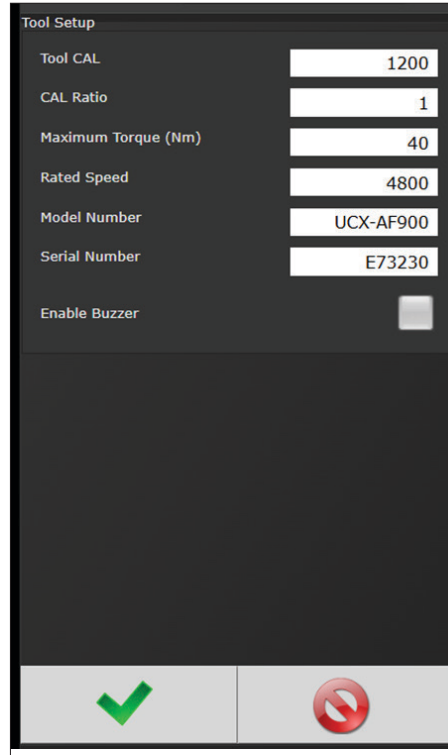

For proper operation of the tool, this information must be entered each time a new tool is connected to the controller.

Tool CAL: Value stamped on tool.
Attention!!! This value must be set correctly before running the tool.

CAL Ratio: Calibration factor for matching the torque reading

of the tool/controller to a torque auditor.

Maximum Torque (Nm): Rated maximum torque of the tool. This is used when determining the default PSets.

Rated Speed: Rated catalog speed of the tool. This is used when determining the default PSets.

Model Number: Optional information only. Recorded in rundown results. Does not affect the operation of the tool

Serial Number: Optional information only. Recorded in rundown results. Does not affect the operation of the tool)

Enable Buzzer: Enables or disables the buzzer

4.5.1.2 Disassembly

- **Overall Timeout (s):** Maximum allowable time the tool is allowed to run after reaching the Threshold Torque when Report Disassembly is enabled.
- **Pulse Timeout (s):** After reaching the Threshold Torque when Report Disassembly is enabled, if the time between pulses is greater than this time the tool stops and an unfastening event is reported.
- **Speed (RPM):** The speed the tool will run in the disassembly direction when the trigger is fully pressed.
- **Report Disassembly:** If enabled, disassembly events are reported and logged.
- **Threshold Torque:** Disassembly will be reported only if this torque value is reached. This is entered as a positive value.
- **Torque Units:** Units for the Disassembly Threshold Torque

Report Disassembly: If enabled, disassembly events will be reported and logged.

Threshold Torque: Disassembly will be reported only if this torque value is reached. This is entered as a positive value.

Torque Units: Units for the Disassembly Threshold Torque

Decrement Fastener Count: If Disassembly is detected the fastener count in JOBS

- **Never:** Decrement count will be ignored
- **Always:** Decrement will always be active
- **Only after NOK:** Decrement count will only happen after a rundown judged to me NOK (Reject) has occurred

Disable on Disassembly: If disassembly is detected the tool will be disabled

Judgment Delay (s): Amount of time (in seconds) after final pulse in disassembly that determines disassembly has been completed

When a disassembly event is reported:

The disassembly will be displayed on the run screens and logged in the rundown record, containing the following:

- Overall evaluation will be marked as 'Disassembled' Peak torque during the disassembly (torque shown as negative).
- Peak overall angle during the disassembly (angle shown as negative).
- Curve data from the disassembly
- Parameters from the current PSet selected
- Fastening events from the disassembly.

All of the controller's status LEDs will be turned OFF. The LED display will show peak torque and angle as negative

I/O Considerations:

If Report Disassembly is enabled:

When disassembly is detected, the IO outputs will reflect the disassembly.

If Report Disassembly is not enabled:

When disassembling, all assignable IO outputs that report rundown status will remain in the state from the last fastening cycle. This includes:

- Ok and Nok signals
- Torque/Angle high or low signals
- Torque and Angle Values

All assignable I/O outputs reporting a fastening events will not change state during the disassembly. This includes:

- Fastening Complete
- In Cycle
- Fastening Stopped
- Fastening Aborted

4.5.2 IO

Assignable IO Menu	
PHYSICAL IO	PHYSICAL IO MONITOR
ANYBUS INPUTS	ANYBUS OUTPUTS
MODBUS TCP INPUTS	MODBUS TCP OUTPUTS
ETHERNET IP INPUTS	ETHERNET IP OUTPUTS

4.5.2.1 Physical IO

Physical IO Configuration			
Input	Function	State	Force
---1---		<input type="checkbox"/>	<input type="checkbox"/>
---2---		<input type="checkbox"/>	<input type="checkbox"/>
---3---	Stop	<input type="checkbox"/>	<input type="checkbox"/>
---4---	Select PSet / [...	<input type="checkbox"/>	<input type="checkbox"/>
---5---	Used By Input:...	<input type="checkbox"/>	<input type="checkbox"/>
---6---	Used By Input:...	<input type="checkbox"/>	<input type="checkbox"/>
---7---	Reset Job	<input type="checkbox"/>	<input type="checkbox"/>
---8---		<input type="checkbox"/>	<input type="checkbox"/>

Output	Function	State	Force
---1---	OK	<input type="checkbox"/>	<input type="checkbox"/>
---2---	NOK	<input type="checkbox"/>	<input type="checkbox"/>
---3---	In Cycle	<input type="checkbox"/>	<input type="checkbox"/>
---4---	Torque High	<input type="checkbox"/>	<input type="checkbox"/>
---5---	Torque Low	<input type="checkbox"/>	<input type="checkbox"/>
---6---	Angle High	<input type="checkbox"/>	<input type="checkbox"/>
---7---	Angle Low	<input type="checkbox"/>	<input type="checkbox"/>
---8---	Job Complete	<input type="checkbox"/>	<input type="checkbox"/>

Assign functionality to 24V Input and Output pins. Shows the "live state" of each Input and Output.

Functions shown in screen shot are default settings.

To change these assignments, click on the "Function" column of the any of the I/O pins. This will open a Output/

Input Configuration screen (following).

Click on the "Force" column of any of the I/O pins to enable or disable the forcing of the selected input or output.

If force is enabled, click on the "State" column to toggle the state of input or output selected.

Input Configuration

Output Configuration

See "10. Assignable I/O" on page 43 for more details on available assignment functions and how to configure.

See "9. 24 Volt I/O" on page 41 for the pinout of the 24Volt Logic IO port, and wiring examples.

4.5.2.2 Physical IO Monitor

Provides monitoring of Physical 24 Volt I/O. Force on/off the individual I/O pins for testing of field wiring.

Each indicator shows the state of the associated pin.

Green = On
Red = Off

- Force:** When Buttons from I/O are selected, this field selects which Inputs and Outputs can be forced through the Monitor I/O screen.

Physical IO Monitor								
Input			Output					
State	Off/On	Force	State	Off/On	Force			
1 <input type="checkbox"/>	<input type="checkbox"/>	<input type="checkbox"/>	5 <input type="checkbox"/>	<input type="checkbox"/>	<input type="checkbox"/>			
2 <input type="checkbox"/>	<input type="checkbox"/>	<input type="checkbox"/>	6 <input type="checkbox"/>	<input type="checkbox"/>	<input type="checkbox"/>			
3 <input type="checkbox"/>	<input type="checkbox"/>	<input type="checkbox"/>	7 <input type="checkbox"/>	<input type="checkbox"/>	<input type="checkbox"/>			
4 <input type="checkbox"/>	<input type="checkbox"/>	<input type="checkbox"/>	8 <input type="checkbox"/>	<input type="checkbox"/>	<input type="checkbox"/>			
Output			Output					
State	Off/On	Force	State	Off/On	Force			
1 <input type="checkbox"/>	<input type="checkbox"/>	<input checked="" type="checkbox"/>	5 <input type="checkbox"/>	<input type="checkbox"/>	<input type="checkbox"/>			
2 <input type="checkbox"/>	<input type="checkbox"/>	<input type="checkbox"/>	6 <input type="checkbox"/>	<input type="checkbox"/>	<input type="checkbox"/>			
3 <input type="checkbox"/>	<input type="checkbox"/>	<input type="checkbox"/>	7 <input type="checkbox"/>	<input type="checkbox"/>	<input type="checkbox"/>			
4 <input type="checkbox"/>	<input type="checkbox"/>	<input type="checkbox"/>	8 <input type="checkbox"/>	<input type="checkbox"/>	<input type="checkbox"/>			

- Off/On:** If Force is enabled this button will toggle the state of input or output selected.

4.5.2.3 Anybus/Modbus TCP/Ethernet IP Inputs

These types of communication are useful for data communication between controller and PLCs. It is an effective, quick way for the data transfer of short data packages.

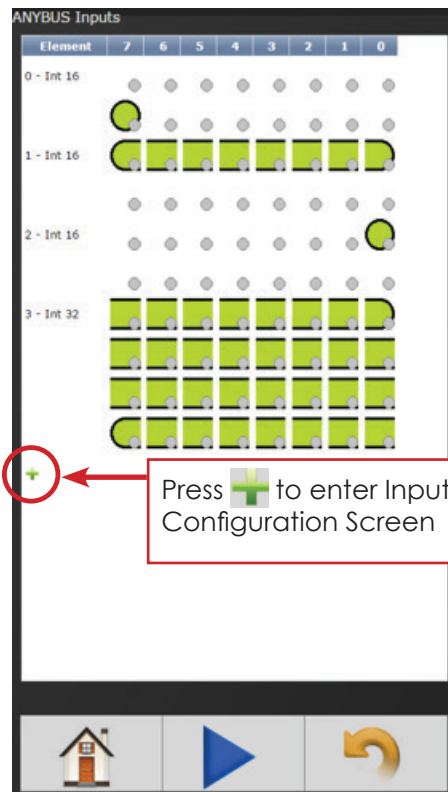

Press to enter Input Configuration Screen

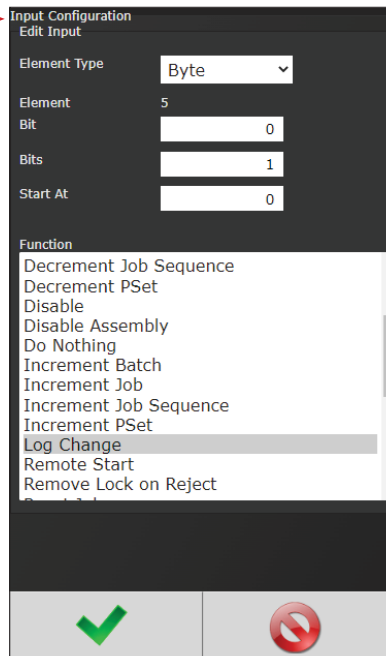

Element Type: Choose from Byte, Int16, Int32, or ASCII.

Element: Shows element # being configured

Bit (not shown): Enter Bit #.

Bits: # of bits the assignment will read.

Start at: Starting bit location.

Polarity (not shown): Select Normally Open (N.O.) or Normally Closed Outputs (N.C.).

Length (not shown, available in ASCII ID function): Number of characters desired to send.

Torque (not shown, available in Click Wrench function): Torque value to be reported when using Click Wrench input. Value input is what will be sent from controller when Input Signal is received from a Click Wrench. **Value is NOT calculated by the controller, rather it is solely what the Click Wrench is calibrated to by outside means.**

Torque Units (not shown, available with Click Wrench function): Choose from Nm, Kgm, Kgcm, Ftlb, and Inlb.

Function: See "10. Assignable I/O" on page 43 for more details on assignable functions.

Click on after appropriate selections are made.

Example of the Anybus Input screen with five Inputs set up.

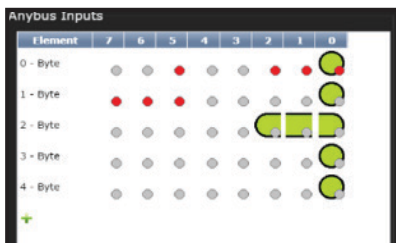



Click on to change an individual Element or return to Input Configuration screen.

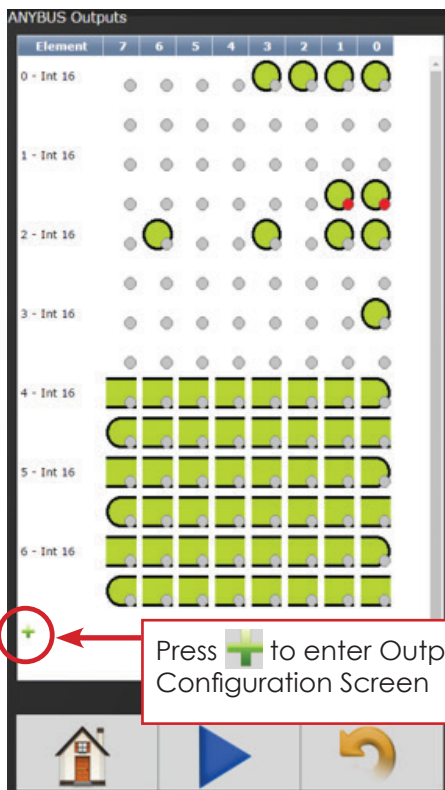

Will delete individual Elements.

4.5.2.4 Anybus/Modbus TCP/Ethernet IP Outputs



Press  to enter Output Configuration Screen

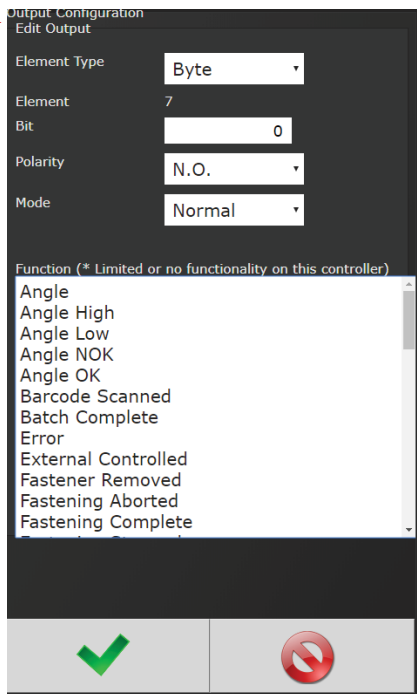

Element Type: Choose from Byte, Int16, Int32, or ASCII.

Element: Shows element # being configured

Bit: Enter Bit #.

Bits (not shown): # of bits the assignment will read.

Start at: Starting bit location.

Polarity: Select Normally Open or Normally Closed Outputs.

- Mode:**
- **Normal:** Output signal sent.
 - **Timed Signal Sent:** Time entered in seconds
 - **Flash Signal Sent:** Time entered in seconds

Function: See "10. Assignable I/O" on page 43 for more details on assignable functions.

Click on  after appropriate changes are made.

Example of the Anybus Output screen with five Outputs set up.

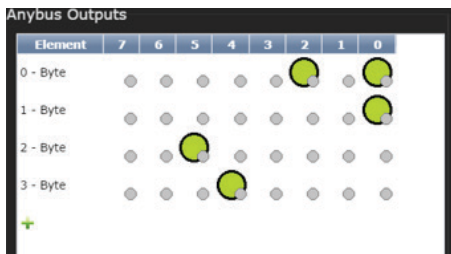

Click on  to change an individual Element or return to Input Configuration screen.

 Will delete individual Elements.

4.5.3 Communication Interfaces

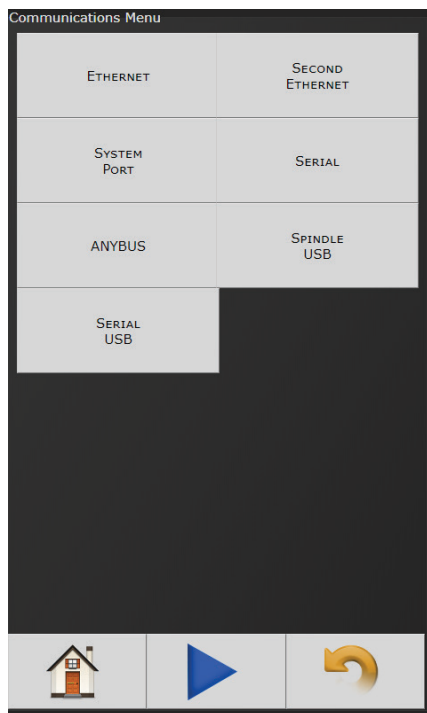

4.5.3.1 Ethernet/Second Ethernet

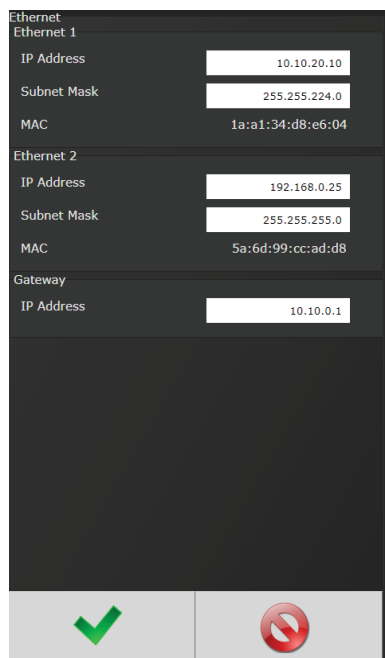

IP Address: IP address of controller's Ethernet port.

Subnet Mask: Subnet mask of the controller.

Gateway: Gateway is the IP address of the gateway computer that provides access beyond the local network.

NOTE: Consult your local System Administrator to connect the controller to your Network and assign IP addresses.

4.5.3.2 System Port

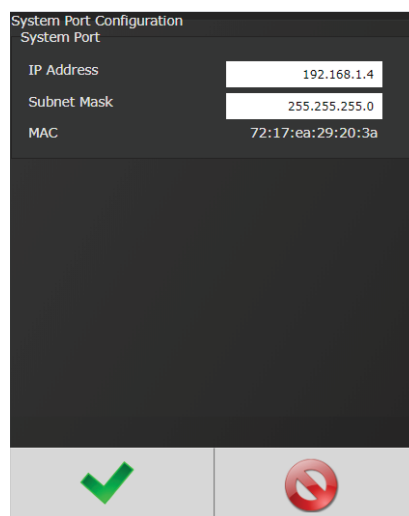

IP Address: The IP address of controller's System Port (Default is 192.168.1.4)

Subnet Mask: The Subnet Mask of controller's System Port.

NOTE: It is not recommended to change this setting.

4.5.3.3 Serial Port

Port Mode: The following modes are available:

- **Serial Output:** A serial data string will be Output after each rundown
- **Barcode Reader:** See "5. Barcode Reader Details" on page 36 for Barcode setup.
- **Serial Output and Barcode Reader:** Select from dropdown and configure per hardware requirements
- **Open Protocol:** Select from dropdown and configure per hardware requirements
- **PFCs:** Select from dropdown and configure per hardware requirements
- **PI Line Control:** This is customer specific. Please reference PI Line Control Document on AIMCO Website/Manuals.
- **Tohnichi Wrench:** Supports connecting a Tohnichi wrench/R-CM receiver to the controller. See Gen IV Serial Instructions on AIMCO Website/Manuals.

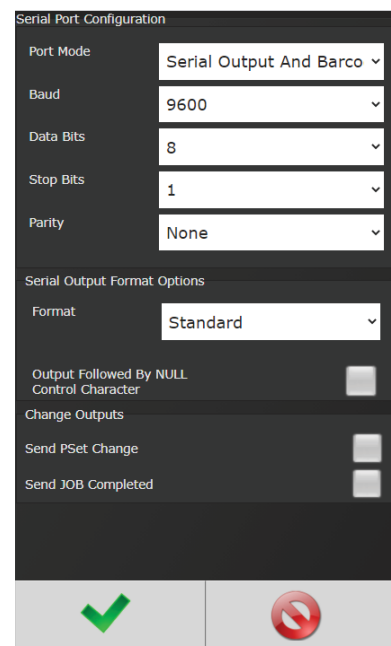

Choosing "Tohnichi Wrench" in Port Mode presents a "Wrench Type" drop down where the appropriate Wrench Type should be selected

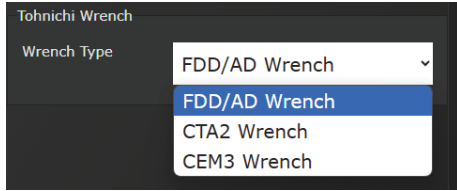

Find instructions for Gen IV/Tohnichi wrench operation at AIMCO Website/Manuals.

Baud: Serial ports can be configured for different baud rates available.

- 75, 110, 300, 1200, 2400, 4800, 9600, 19200, 38400, 57600, 115200

Data Bits / Stop Bits / Parity: Configure per hardware requirements

Serial Output Format Options: See following section "Serial Output Format Options" on page 25 for details.

- Standard
- Standard with PSet
- UEC Serial Modified
- Profibus
- UEC Serial
- CVS String

Output Followed by Null Control Character: Adds a one-byte NULL character to the end of the serial string. Needed by systems that use the NULL character to signify the end of the string. See following section.

Send PSet Change

- Sends a serial string any time the PSet is changed. String is in the form '%CAN8X%CAN4YNAC%' where X is the previous pset and Y is the new pset. See following section for more information.

Send Job Completed:

- Sends a serial string containing "Job Completed" whenever a job has been completed.

Gen IV Serial Port Pin-out

Pin	Signal
1	
2	RX
3	TX
4	DTR
5	GND
6	
7	
8	
9	

Pin 1 Pin 5

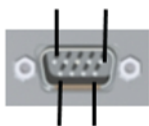

Pin 6 Pin 9

4.5.3.4 Anybus

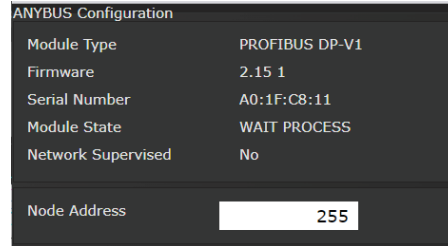

Displays when the controller is AnyBus-enabled by hardware

4.5.3.5 Spindle USB Port

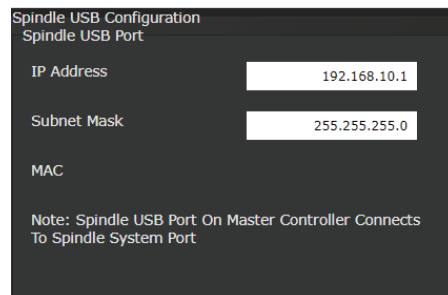

This can be used to set up a 2 spindle network through the USB port.

4.5.3.6 Serial USB

See "4.5.3.3 Serial Port" on page 23 for reference

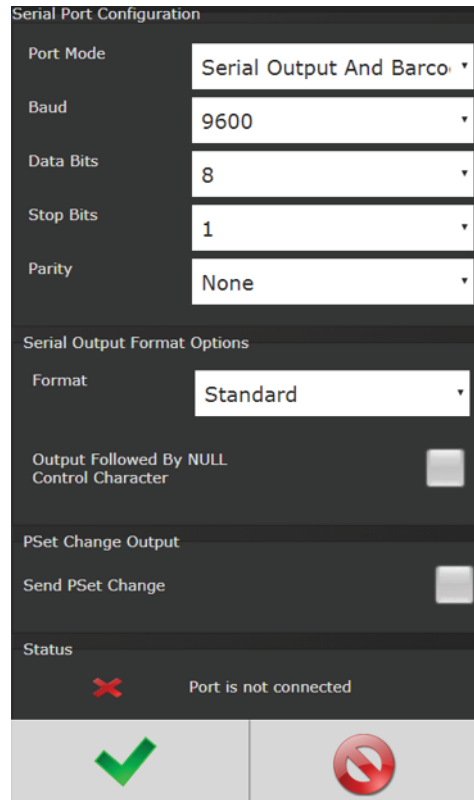

Serial Output Format Options

Standard Output Format:

- O P HHHHH LLLLL TTTT P HHHHH LLLLL AAAAA CR CR NULL*
 - O: Overall Pass/Fail
 - 'P' = Pass, 'F' = Fail
 - P: Torque Pass/Fail
 - 'P' = Pass, 'F' = Fail
 - HHHHH: Torque High Limit
 - Units selected in the PSet X10
 - LLLLL: Torque Low Limit
 - Units selected in the PSet X10
 - TTTT: Torque Result
 - Units selected in the PSet X10
 - P: Angle Pass/Fail
 - 'P' = Pass, 'F' = Fail
 - HHHHH: Angle High Limit
 - Degrees
 - LLLLL: Angle Low Limit
 - Degrees
 - AAAAA: Angle Result
 - Degrees
 - CR: Carriage return control character
 - CR: Carriage return control character
 - NULL*: Null control character (*if option is selected)

Standard Output with Carriage Return, Line Feed and PSet Format:

- O P HHHHH LLLLL TTTT P HHHHH LLLLL AAAAA 1 CR LF NULL*
 - O: Overall Pass/Fail
 - 'P' = Pass, 'F' = Fail
 - P: Torque Pass/Fail
 - 'P' = Pass, 'F' = Fail
 - HHHHH: Torque High Limit
 - Units selected in the PSet X10
 - LLLLL: Torque Low Limit
 - Units selected in the PSet X10
 - TTTT: Torque Result
 - Units selected in the PSet X10
 - P: Angle Pass/Fail
 - 'P' = Pass, 'F' = Fail
 - HHHHH: Angle High Limit
 - Degrees
 - LLLLL: Angle Low Limit
 - Degrees
 - AAAAA: Angle Result
 - Degrees
 - 1: PSet
 - PSet('1' - '9') for PSets 1-9, ('A' - 'Z') for PSets 10-35
 - CR: Carriage return control character
 - LF: Line feed control character
 - NULL*: Null control character (*if option is selected)

UEC Serial Modified Format (matches some Gen4 earlier versions):

- # P 1 BB TTT.T AAAA PPPP 0000 J CR NULL*
 - #: Message Start
 - P: PSet
 - PSet('1' - '9') for PSets 1-9, ('A' - 'Z') for PSets 10-35
 - 1: Spindle Number (Always 1)
 - BB: Job Bolt Count
 - Total number of accepts during the Job
 - TTT.T: Torque Result
 - Units selected in the PSet
 - AAAA: Angle Result
 - Degrees
 - PPPP: Pulse Count
 - 0000
 - J: Judgment
 - '@' = Overall Pass, 'H' = Low Torque, 'I' = High Torque, 'J' = Low Angle, 'K' = High Angle, 'G' = Fault During Fastening
 - CR: Carriage return control character
 - NULL*: Null control character (*if option is selected)

Profibus Output Format:

- %CAN 1 O P HHHHH LLLLL TTTT P HHHHH LLLLL AAAAA NAC% CR LF NULL*
 - %CAN: Message Start
 - 1: PSet
 - PSet('1' - '9') for PSets 1-9, ('A' - 'Z') for PSets 10-35

- O: Overall Pass/Fail
 - 'P' = Pass, 'F' = Fail
- P: Torque Pass/Fail
 - 'P' = Pass, 'F' = Fail
- HHHHH: Torque High Limit
 - Units selected in the PSet X10
- LLLLL: Torque Low Limit
 - Units selected in the PSet X10
- TTTT: Torque Result
 - Units selected in the PSet X10
- P: Angle Pass/Fail
 - 'P' = Pass, 'F' = Fail
- HHHHH: Angle High Limit
 - Degrees
- LLLLL: Angle Low Limit
 - Degrees
- AAAAA: Angle Result
 - Degrees
- NAC%: Message End
- CR: Carriage return control character
- LF: Line feed control character
- NULL*: Null control character (*if option is selected)

UEC Serial Format (matches UEC 4800 and Gen3):

- # 1 P BB TTT.T AAAA PPPP 0000 J CR NULL*
 - #: Message Start
 - 1: Spindle Number (Always 1)
 - P: PSet
 - PSet('1' - '9') for PSets 1-9, ('A' - 'Z') for PSets 10-35
 - BB: Job Bolt Count
 - Total number of accepts during the Job
 - TTT.T: Torque Result
 - Units selected in the PSet
 - AAAA: Angle Result
 - Degrees
 - PPPP: Pulse Count
 - L = Low Pulse Count, M = High Pulse Count
 - 0000
 - J: Judgment
 - '@' = Overall Pass, 'H' = Low Torque, 'I' = High Torque, 'J' = Low Angle, 'K' = High Angle, 'G' = Fault During Fastening, '*' = None of these conditions apply
 - CR: Carriage return control character
 - NULL*: Null control character (*if option is selected)

'CSV String'

- S01,JB01, TTT.T, S, AAA.A, S, O, MM/DD/YYYY HH:MM:SS, VVV<CR><LF>
 - S01: Spindle number
 - JB01: Job number
 - TTT.T: Torque
 - S: Torque Status (A = OK, H = High, L = Low)
 - AAA.A: Angle
 - S: Angle Status (A = OK, H = High, L = Low)
 - O: Overall Status (A = OK, R = NOK)
 - MM: Month
 - DD: Day
 - YYYY: Year
 - HH: Hour
 - MM: Minute
 - SS: Second
 - VVV: 32 character barcode ID
 - <CR>: Carriage Return
 - <LF>: Line Feed

'Output Followed by NULL Character'

- The NULL characters can be seen by using PUTTY and connecting to the controller in 'Raw' mode. Then set logging to log all output and check the log to see the NULL characters.

'Send PSet Change'

- PSets up to 9 match the number, 10-35 are A-Z, greater than 35 is '*':
 - %%CAN8X%%CAN4YNAC%%
 - X: Last PSet
 - Y: New PSet

4.5.4 Protocols

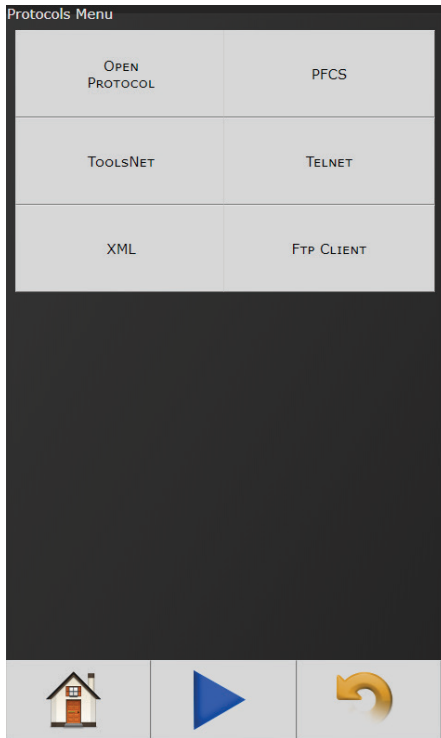

For information about these settings, see individual protocol instructions on AIMCO's website at www.aimco-global.com/manuals

4.5.5 Front Panel Buttons

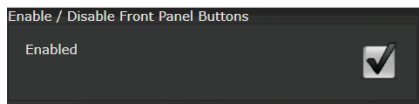

Enable/ Disable front panel buttons on controller console.

4.5.6 Power Up

Allows user several "Job" choices upon controller Power Up:

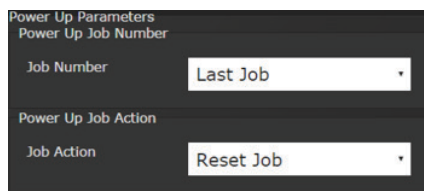

Power Up Job

Number: Controller will power up on the job # selected.

- **Last Job:** When "Last job" is selected, controller will power up on last job selected prior to being Powered Down.

Power Up Job Action

- **Reset Job:** Job will be reset when controller is Powered Up.
- **Wait for Job Reset:** Controller will wait for an External Job reset command upon Power Up and will retain job information existing prior to power down.
- **Resume Last Job:** Upon Power Up, tightening sequence will resume at the next fastening from the point in the job when power was shut down.

4.5.7 Bar Code Setup

Required Identifiers for Tool Enable: Selects which four Identifiers (ID# 1-4) are required to enable tool.

Reset Identifiers on Job Complete: Selects which four Identifiers (ID# 1-4) to reset on a job complete. Select Identifiers by clicking on them.

Block New Identifiers While Job is Running:

Check to enable feature that ignores any barcode scanning while a JOB is in progress

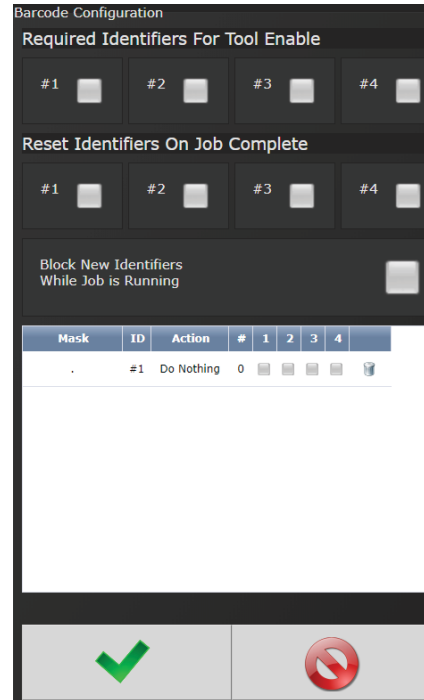

Step 2: Enter appropriate information on Barcode ID Configuration Screen.

Identifier Mask: The Mask is a string used to compare the received barcode against. The received barcode must be at least as long in length as the Mask. The Mask can also contain "don't care"

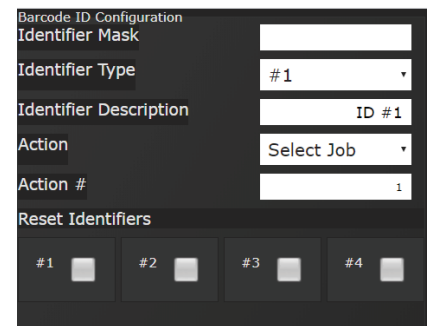

characters of a decimal point or period in the string. These characters are counted in the length, however, the actual received character in that position doesn't matter.

Example:



VIN# 123456

Identifier Type: Identifies which identifier (ID# 1-4) received barcode will be stored into.

Identifier Description: Text field can be used to give a description to each identifier type. (Example: Vehicle).

Action: Action executed by controller when barcode with a matching identifier mask is scanned. The actions are:

- Select Job (This will require a Job to be configured on the JOB page when using this option)
- Do Nothing
- Select PSet

Action#: When Select Job or Select PSet is selected, this is the number of the Job or PSet that will be selected.

Reset Identifiers: Can reset other identifiers (ID#1-4) when barcode is received. Click on identifiers to reset.

Step 3: Press  to save and re-enter completed barcode configuration screen.

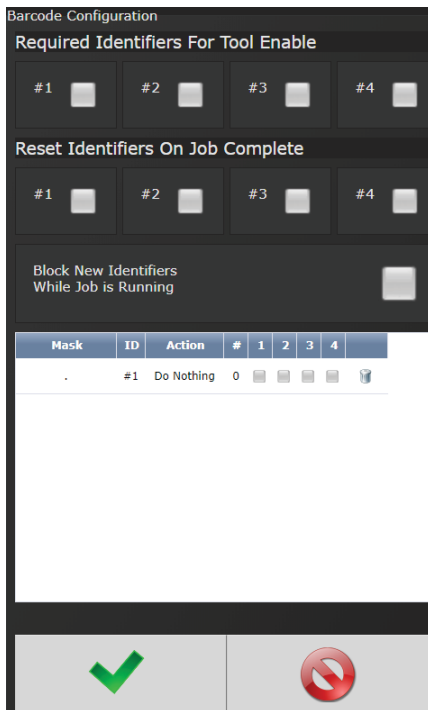

Click anywhere in body if additional identifiers are required.

Press  to save barcode configuration.

See "5. Barcode Reader Details" on page 36 for more information)

To configure Serial Port for Barcode Reader: On Home page click Controller → Communication Interfaces → Serial

Select Barcode Reader and the correct Baud rate.

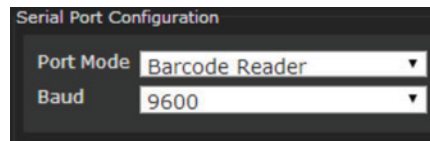

Press  to save changes.

4.5.8 Set Time

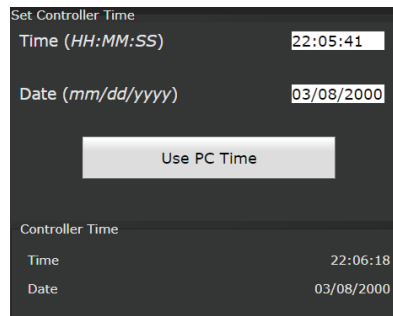

Set time and date. If connected to a PC, use PC Time to set controller time.

4.5.9 Remote Connections

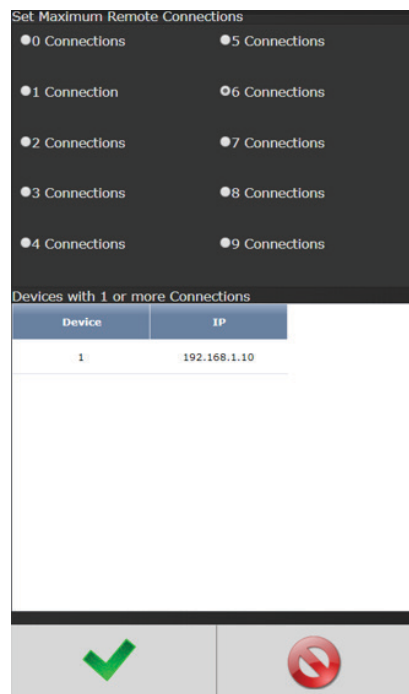

Sets number of remote browser connections to controller.

Displays the IP addresses of remote browser connections to the controller.

4.5.10 Languages

Select from:

- English
- Chinese
- Japanese
- Korean
- Spanish
- Portuguese

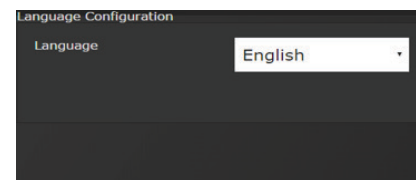

4.6 Accessories



This screen shows accessories configured in the controller. New accessories can be added, edited, and deleted using the buttons at the bottom of the table.

To add a new accessory, press or to navigate to the Accessory Scanning and Setup page.

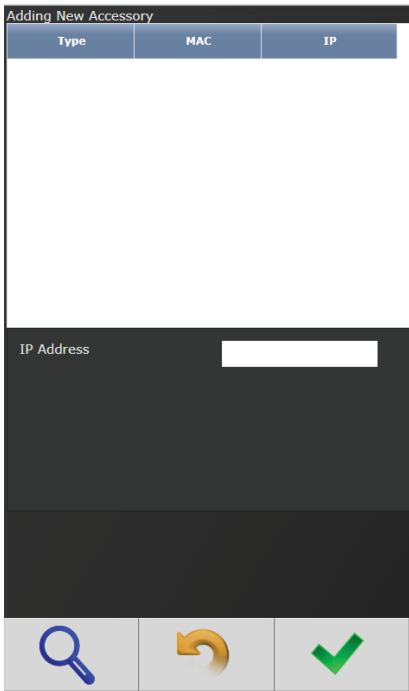

Press the scan button to search for AcraDyne accessories on the network or enter the IP address of the accessory manually

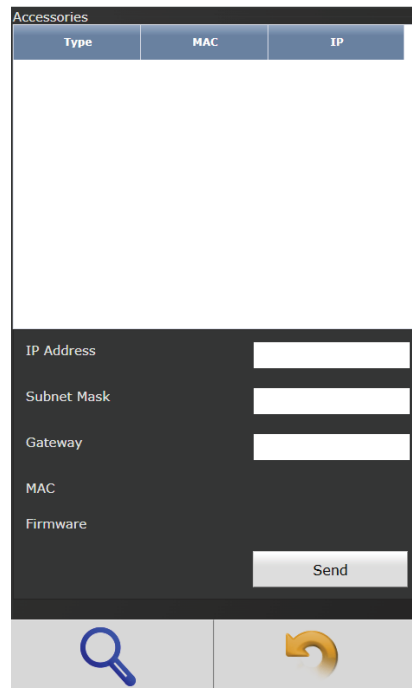

The Smart Arm Accessory allows an articulated arm with encoders to be used with the Gen IV controller. Fastener locations can be programmed into the controller so that the controller will perform specific actions when the tool is located on a specific fastener.

4.7 Diagnostics

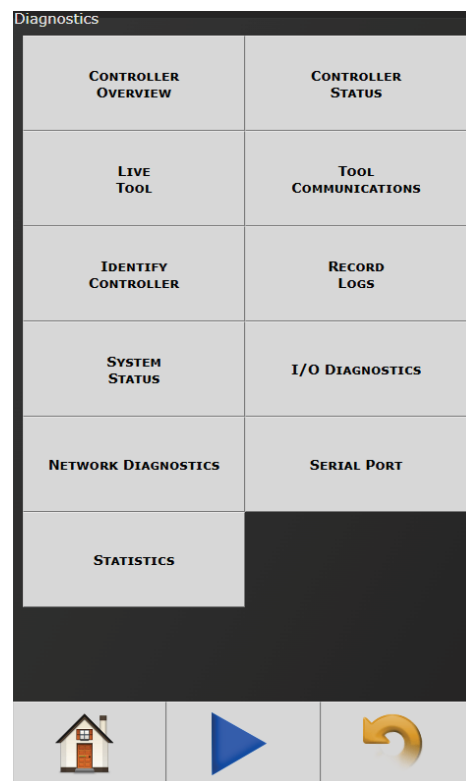

The Diagnostics menu contains all pertinent information regarding unusual behavior of the system. Detailed descriptions are given in the following sections.

4.7.1 Controller Overview

Model Number:
Model Number of the controller.

Serial Number:
Serial Number of the controller.

Type: Type of controller:

- **ICC:**
Intelligent UCX-AF Series Tool Controller

SYSREL: System Release # shown

Application:
Current Application software version.

Firmware: Current Firmware software version.

Available Hardware: Available hardware on the controller.

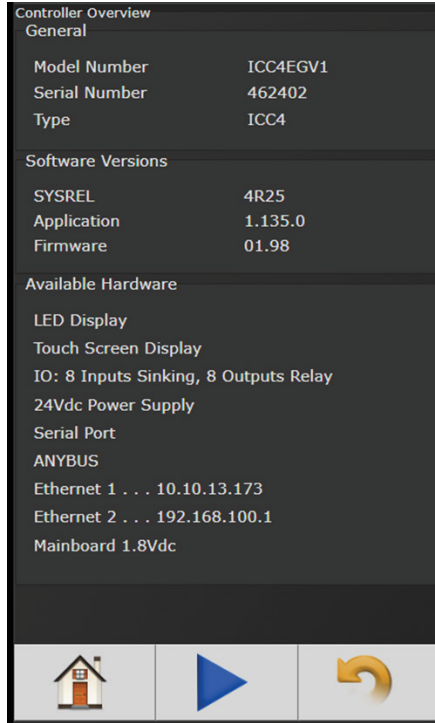

Bus Voltages: Alarm icon will appear on controller console and under "Active Faults" (see below) if any of these values are out of range:

- **24 Vdc:** Represents voltage from 24V power supply. Value is reported as on or off (.0-24.0 volts) and is for external use via 24V I/O port.
- **15 Vdc and -15Vdc:** These are voltages that power the torque transducer for IAC & IPC controllers only
- **5 Vdc:** Represents voltage from 5V power supply powering controller electronics.
- **3.3 Vdc:** Represents controller electronics internal 3.3V Bus voltage.
- **SOM 1.8 Vdc:** Represents controller electronics internal 1.8V Bus voltage
- **Mainboard 1.8 Vdc:** Represents controller electronics internal 1.8V Bus voltage
- **Torque Vdc:** Status indication of tool transducer voltage

CPU Temperature (° C): Represents temperature of CPU measured in Celsius.

Mainboard Temperature (° C): Represents temperature inside controller measures in Celsius.

Active Faults: Any tool/ controller faults will be shown in this area.

4.7.2 Controller Status

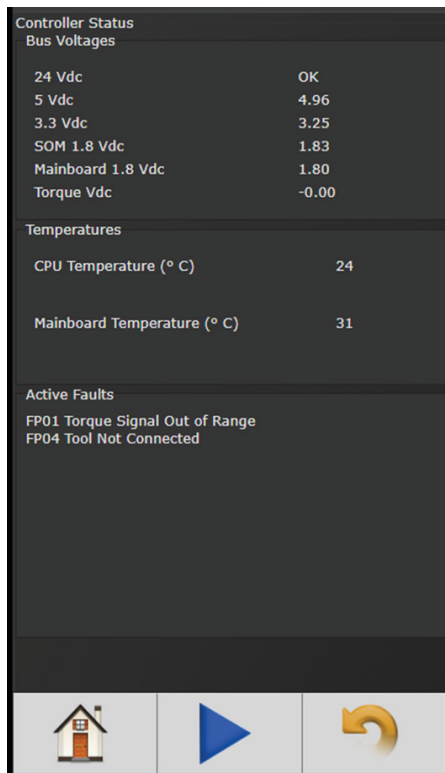

Shows "Live" status of controller, voltages, active faults, and temperature.

4.7.3 Live Tool Features

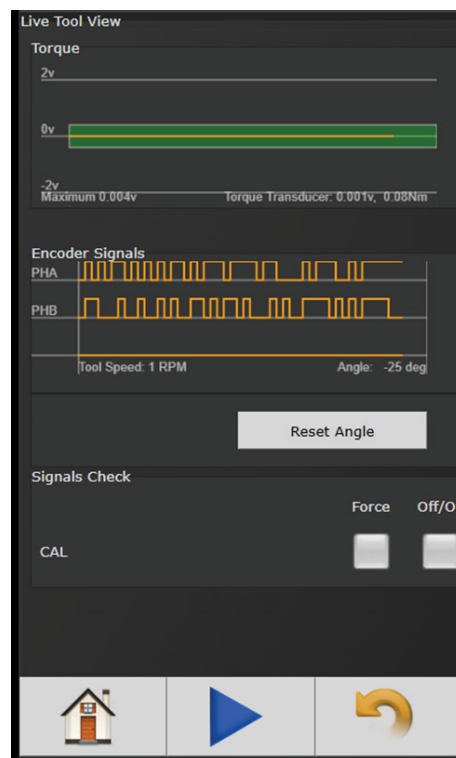

Torque: Shows a live view of tool transducer in volts. Voltage will be approximately 2.0 volts (± 0.005 Vdc) when tool is at rest and torque is zero (verify the voltage is within the green zone in the graph).

During a rundown, tool transducer voltage increases as torque increases.

Encoder Signals will be monitored along with tool RPM. (Only applies for tools with Angle Sensing capability 'Resolver')

Signals Check: Encoders sensors can be monitored for function and reliability

CAL: A CAL signals check can also be toggled. Forcing the cal check will drive the torque transducer voltage to near 2.0V if the tool is operating correctly.

4.7.4 Tool Communications

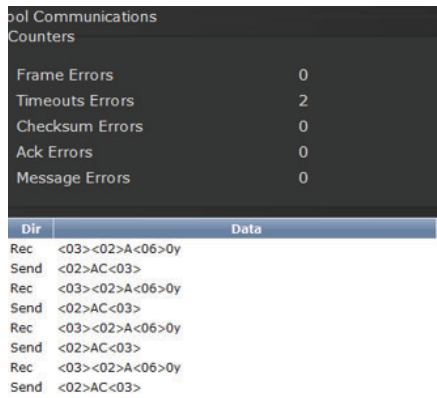

Access this screen to view the communications between the tool and controller. Data should be continually streaming if the system is working normally. This can be used to identify issues with tool communication. If no data is being sent between the tool and controller then there may be a hardware problem. These logs can be



saved for troubleshooting purposes.

4.7.5 Identify Controller

'Identify Controller' will cause lights on controller and tool to flash making the system easy to locate. This is especially helpful when programming is being done and multiple controllers are being used in close proximity to each other.

4.7.6 Record Logs

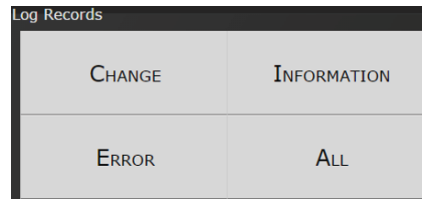

Logs information describing usage of controller and tools that have been used with that controller.

4.7.6.1 Change Log

Log displays changes made to tool or controller.

4.7.6.2 Information Log

Log displays all information entries.

4.7.6.3 Error Log

Log displays ONLY Error Entries.

4.7.6.4 All

Displays all Changes, Information and Error entries.

4.7.7 System Status

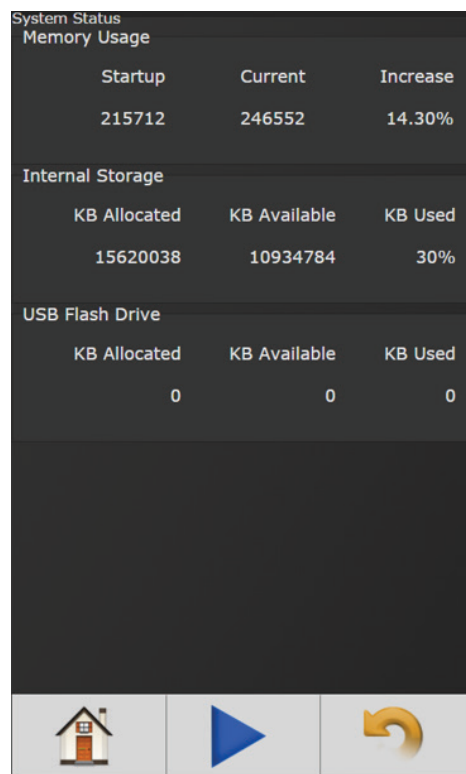

4.7.8 I/O Diagnostics

Assignable I/O Diagnostics			
I/O	Bus	Assignment	I/O St...
In	24v	Select Job	0
In	24v	Select Job	1
Out	24v	Torque High	0
Out	24v	NOK	0
Out	Abus	Angle	0
Out	Abus	Angle	0
Out	Abus	Torque (x10)	0
Out	Abus	NOK	0
Out	Abus	Torque High	0
Out	Abus	Tool Enabled	1
Out	Abus	Tool Enabled	0
In	24v	Reverse	0
Out	Abus	External Controlled	0

This screen shows a record of the last changes in state of all the assigned I/O that are active. Record can be saved to diagnose I/O functionality

4.7.9 Network Diagnostics

Network Diagnostics can be useful in troubleshooting Ethernet communication issues

Network Diagnostics
Ethernet

Ethernet 1	State	Address
Ethernet 2	up	10.10.5.50
	down	

Test Connection

IP Address:

Capture

Interface:

Number of Packets:

Ethernet: Shows if the Ethernet port is physically connected and if the hardware is operational.

Test Connection: Provides a way to check the ethernet connection to other devices on the same network.

Capture: Captures and saves the ethernet traffic for evaluation

4.7.10 Serial Port Diagnostics

The Serial Port Diagnostics page shows all serial communications coming in and out of the controller. Select between Enclosure Serial Port (RS232/DB9 port) and USB Serial Port communications.

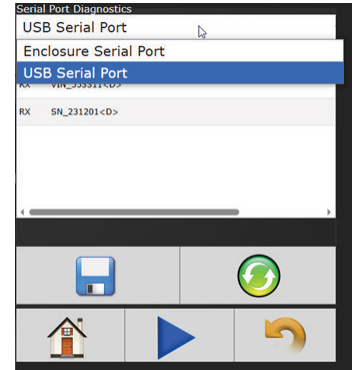

The Refresh button updates the screen with the most recent communications.

The Save button generates a log file that can be viewed on a PC and downloaded. This file can also be saved to a USB drive when using the controller touch screen. This saved CSV file contains a timestamped record of all communications since the last time the controller restarted.

4.7.11 Statistics

Enter the desired number of samples and PSET to observe calculated statistics. Number of samples must be equal to or less than the existing recent results stored within the controller. Statistics are presented as a courtesy to users who wish to review them in quick fashion on the controller screen.

Statistics, 3 Samples		
	Torque	Angle
LSL	10.00 Nm	0°
Target	15.00 Nm	--
USL	20.00 Nm	0°
Min	32.42 Nm	4°
Max	45.87 Nm	132°
Range	13.45 Nm	128°
Low	0.0%	--
Ok	0.0%	--
High	100.0%	--
\bar{x}	41.33 Nm	88.77°
σ	7.72 Nm	73.04°
$\bar{x} - 3\sigma$	18.18 Nm	-130.35°
$\bar{x} + 3\sigma$	64.48 Nm	307.88°
6σ	46.31 Nm	438.23°
$6\sigma / \bar{x}$	1.12	4.94
Cp	0.22	--
Cpk	-0.92	--

Sample Size:

PSet:

The Lower Spec Limit (LSL) and Upper Spec Limit (USL) are the lowest and highest torque or angle values that should occur in the audit torque or angle stage. By default, the audit torque or angle stage is the last auditable stage. This can be changed in PSet → Edit Stage → Audit Options.

4.8 Login

When a password is required it can be entered in this screen.

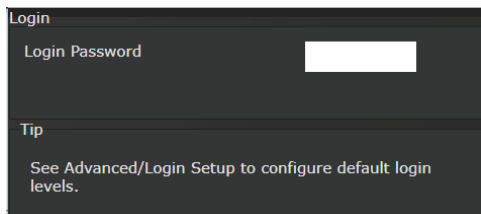

Three levels of access to the controller are available:

- **Operator:** Run/Login/View PSet screens available.
- **Technician:** Run/PSet/Job/Diagnostics and Login screens available.
- **Administrator:** All screens available.

4.9 Advanced

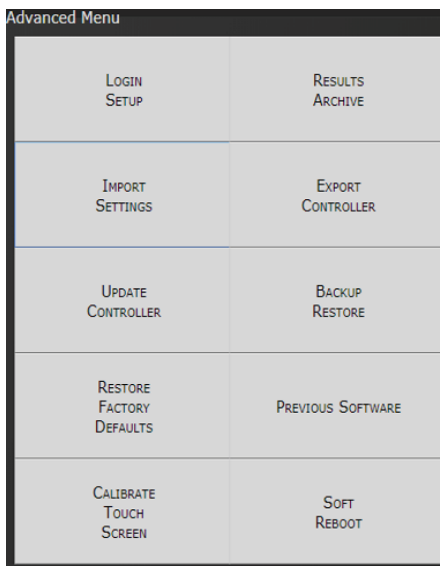

The 'Advanced' menu handles complex settings within the controller. Detailed descriptions are given in the following sections.

4.9.1 Login Setup

This screen allows the user to select the default Login level upon controller start up.

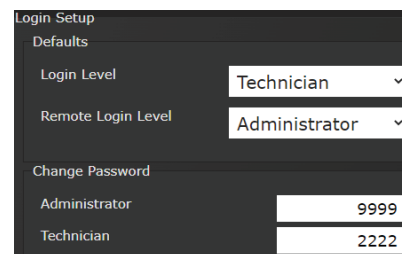

- **Operator**
- **Technician**
- **Administrator**

The Remote Login Level sets the default login level for remote sessions, allowing administrators to avoid logging in when accessing the controller over the network.

4.9.2 Results Archive

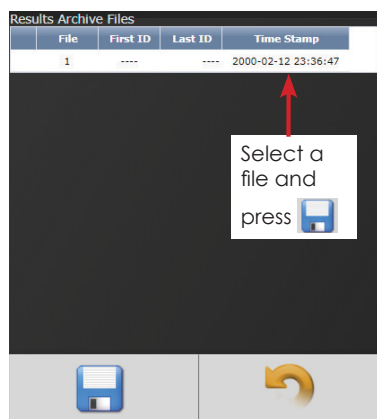

Approximately one million rundowns can be stored. Twenty files with approximately 50,000 rundowns are maintained at a time. The user can, at any time, save the runs to either a USB stick or to the Web as a CSV file imported directly into an Excel spreadsheet.

Using the touchscreen console, you can select multiple files to save.

Using the web option, you can select one of these files at a time to save (web option is default).

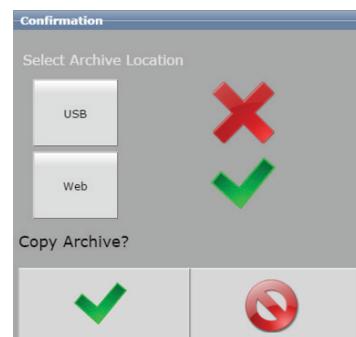

Select either USB or Web Archive location. See example of saved Excel files below

Example of Saved Excel File

Rundown	Job Num	Job Name	Sequence	Bolt count	Status	Date	Time	Torque	Status	Angle	Status	PSet Num	PSet Name	Tool Mod	Tool Serial	Id1 (ID #1)	Id2 (ID #2)	Id3 (ID #3)	Id4 (ID #4)
2068	0		0	0	P	#####	11:13:42	5.08	P	480	--	1			0				
2069	0		0	0	P	#####	11:13:49	5.054	P	535	--	1			0				
2070	0		0	0	P	#####	11:13:50	5.002	P	450	--	1			0				
2071	0		0	0	P	#####	11:13:52	5.013	P	595	--	1			0				
2072	0		0	0	P	#####	11:13:53	5.085	P	495	--	1			0				
2073	0		0	0	P	#####	11:13:54	5.1	P	440	--	1			0				
2074	0		0	0	P	#####	11:13:56	5.089	P	575	--	1			0				

4.9.3 Import Settings

This allows the user to download any previously saved settings onto the controller (refer to 'Export Controller' for help with saving data).

1. Plug the USB with an export file into any port on the controller.
2. From the Home screen, navigate to Advanced → Import Settings.
3. Select the settings to be checking the

corresponding box

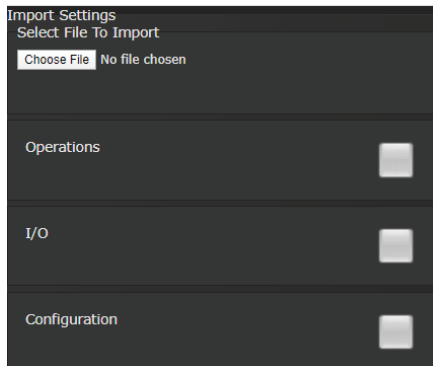

Operations: This includes PSets and Jobs.

I/O: This includes I/O settings for the local I/O, Anybus, Modbus, and EtherNet/IP.

Configuration: This includes all settings of the controller except I/O, Master Spindle, Rundowns, PSets or Jobs.

Spindle: This includes any Master Spindle setup (i.e. number of spindles, IP addresses, etc).

4. Press to accept the changes.
5. Press to proceed.
6. Press when the import is complete and the controller will restart.

Import settings that were exported from another controller via a USB flash drive. Use this to quickly apply the same settings across several controllers. For example, it is common to have multiple controllers with the same I/O configuration. Set up one controller with the correct I/O configuration and export the controller from Advanced → Export Controller. Now the I/O settings can be imported using this screen.

NOTE: Setting can only be imported from controllers running the same version of software.

4.9.4 Export Controller

This allows the user to save Configuration, Operations, I/O, and Spindle settings onto a USB flash drive.

1. Plug a USB into any port on the controller.
2. From the Home screen, navigate to Advanced → Export Controller.
3. Press to continue, and the controller will begin the export process.

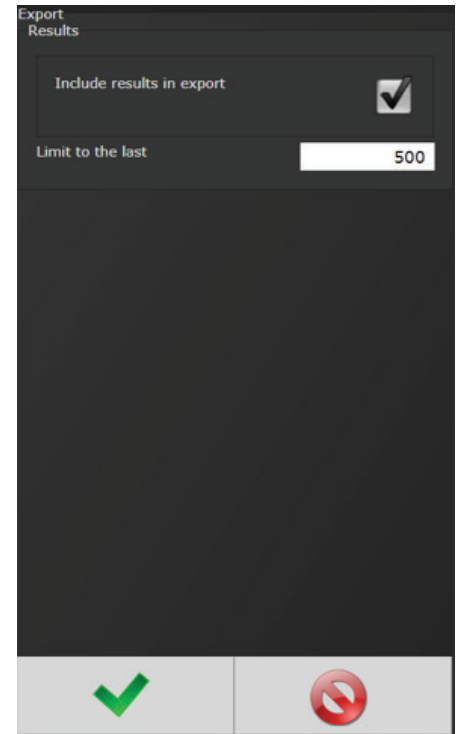

4. Press to complete the export.

4.9.5 Update Controller

The following screen will appear showing current software and firmware versions, as well as a link to the [AIMCO software website](#) where you can download the current software version.

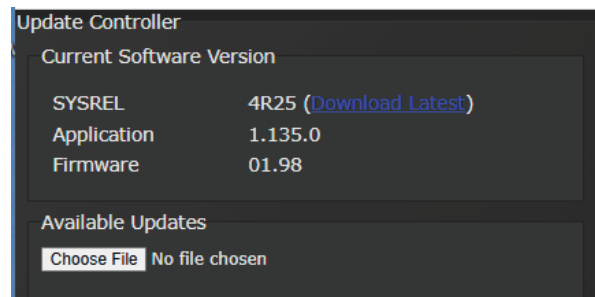

NOTE: Updated firmware versions will typically be sent via email zip file. Always save PSet and IP address information before upgrading controller.

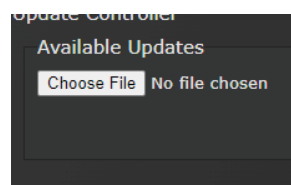

If updating through a system port browser session, a dialog box will appear. Click the Choose File button and navigate to the folder where the zip file you downloaded from the AIMCO website is located on the computer. Select the latest release and click  when ready.

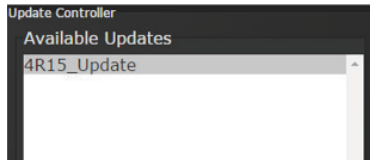

If a USB stick containing the zip file has been plugged in to the controller, the file will show in the

Available Updates list. Select the latest release and click  when ready.

After the controller restarts, the user should see following messages

Updating System

Do not unplug USB

Do not Power Off Controller

This may take a few minutes...

Controller Upgrade Notification

When the controller has finished, navigate to Diagnostics → Controller Overview to view any changes to the 'Software Versions'. Any system settings (Ethernet IP address, PSets, Jobs, etc.) will remain unchanged.

4.9.6 Backup Restore

The Backup function allows the user to create an image of the controller software/firmware including all Configurations, Operations, I/O, and Spindle settings. This is used to create a point in which the controller can restore to if the need arises. In that case, the Restore function would be used.

1. From the Home screen, navigate to Advanced → Backup Restore.
2. Press Backup to initialize the backup process.

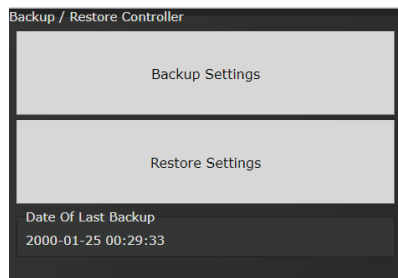

3. Press  to replace previous backup with current system, the backup process will begin.

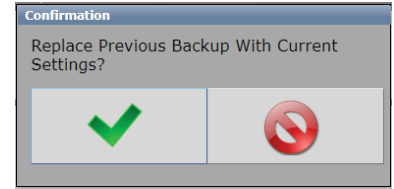

4. Press **Restore** to initialize the restore process.

5. Press  to restore all settings and firmware to last backup, the restore process will begin.

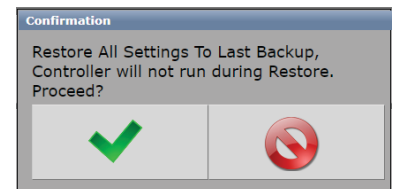

6. The controller will restart when finished.

4.9.7 Restore Factory Defaults

This allows the user to reset the controller's parameters to factory settings

1. From the Home screen, navigate to Advanced → Restore Factory Defaults.
2. Select the settings to be changed and accept .

- **Operations:** This includes PSets and Jobs.
- **I/O:** This includes I/O settings for the local I/O, Anybus, Modbus, and EtherNet/IP.
- **Configuration:** This includes all settings of the controller except I/O, Master Spindle, Rundowns, PSets or Jobs.
- **Results:** This includes all rundown data /information
- **Log:** This includes the Change, Information, Error, and Combined logs.

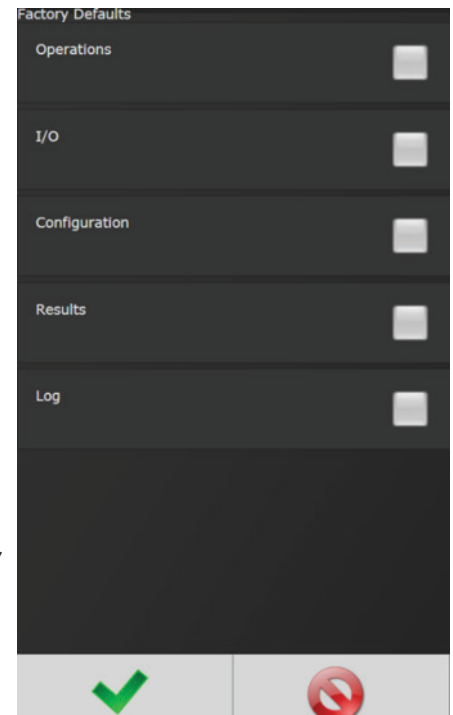

3. Press  to accept the changes.

4. Press  to proceed.

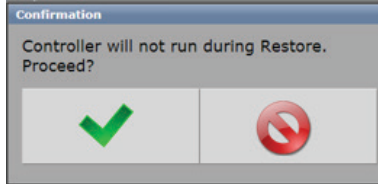

5. Press  when the calibration is complete, the controller will restart.

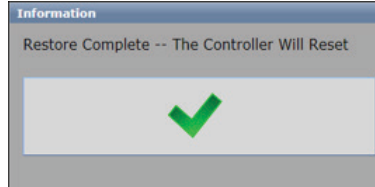

Custom Calibration: This allows the user to create a custom calibration setting for the touch screen.

Factory Default Calibration: This calibrates the touchscreen to the factory defaults.

4. Press  to accept the selection.

5. Press  to proceed.

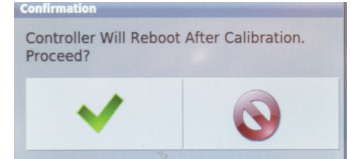

In the case of custom calibration, a screen will appear with instructions on how to increase precision.

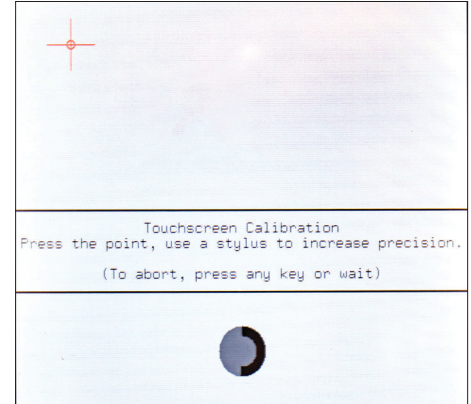

6. Press  when the calibration is complete, the controller will restart.

NOTE: The controller may need to be reset before the custom calibration is possible.

4.9.8 Previous Software

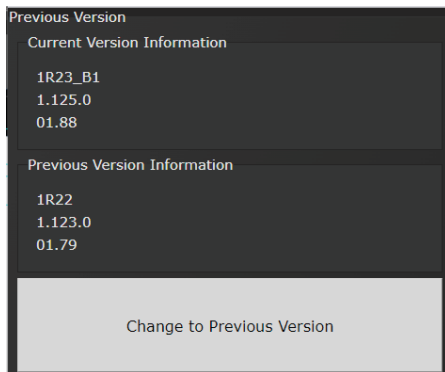

The 'Previous Software' page enables users to change the software to an alternate version. When the controller is updated, the previous version will be retained to easily revert

versions. Settings are not affected. Any changes to settings are retained when changing to an alternate version. The screen shows the current version along with the version information of the alternate version.

This feature is only available for versions 3R19 going forward. It is not possible to revert to a release earlier than 3R19.

4.9.9 Calibrate Touch Screen

Custom and Factory default calibration are available on the controller console.

1. From the Home screen on the controller console, navigate to Advanced → Calibrate Touch Screen.

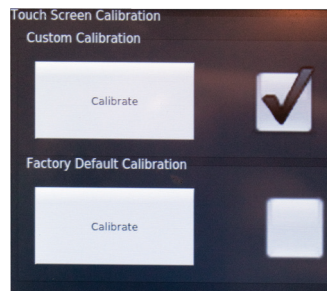

2. Press  to disable the tool.
3. Select the desired calibration

4.9.10 Soft Reboot

Restart the controller without turning the power off.

1. From the Home screen on the controller interface, navigate to Advanced → Soft Reboot.

2. Press  to proceed, the controller will restart.

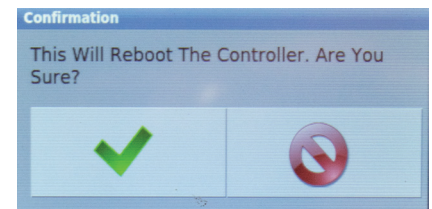

5. Barcode Reader Details

The Gen IV controller supports the following barcode reader functionality:

- Support up to four identifiers.
- Each rundown result can be associated with up to four identifiers.
- Identifier(s) can be used to select a parameter set or a job.
- Display identifier(s) on controller.
- Ability to lock-out tool until correct identifier(s) is entered.
- Ability to block barcode reads while a job is in progress.
- Barcode reads (identifiers) can come from any or all the following sources:
 - Serial barcode reader
 - Open protocol
 - Fieldbus network
 - Telnet port

Solution

Regardless of the source (serial barcode reader, telnet, fieldbus, or protocol) each new string is passed through the same process:

- All four identifiers are reset to an empty string on power-up.
- Each received barcode is processed through a Barcode Match Table to look for a match, if one is found the barcode is accepted.
- Each fastening will then be associated with the received barcode(s) until a new one is received or they are reset.

Parameters

The parameters that pertain to the processing of barcode strings:

- The Barcode Match Table is used to identify the newly received barcode string.
- Which of the four Identifiers (ID#1-4) are required to enable the tool?
- Which of the four Identifiers (ID#1-4) to reset on a job complete?
- Parameter to disable all barcode reads while a job is in progress. If set, barcode reads will be disabled after the first fastener is ran until job is complete.

Barcode Match Table

The Barcode Match Table is used to identify which barcode has been received. The controller can have up to 99 entries (rows) in the table. Each entry has actions that will be performed when a matching barcode is received. The table is searched from

top to bottom in an attempt to find a matching barcode. If none are found, the barcode is ignored.

Mask

The Mask is a string used to compare against the received barcode. The received barcode must be at least as long in length as the Mask. The Mask can also contain "don't care" characters of a decimal point or period in the string. These "don't care" characters are counted in the length but the actual received character in that position doesn't matter.

Identifier Type

The "Identifier Type" field identifies which identifier (ID#1-4) the received barcode will be stored in.

Action

Action can be one of the following:

- None
- Select PS#1-256
- Select Job#1-20

Reset ID

The "Reset ID" has the ability to reset other identifiers (ID#1-4) when barcode is received.

Examples:

Operator Scans

When a vehicle enters the station, the operator scans the VIN. The controller selects the correct job number and enables the tool. Each fastener will be identified with this VIN stored locally, and/or sent to a server for storage. The job settings will disable the tool when the job is complete.

Setup

In this example, there are three possible vehicle types each with its own job. The barcode scan will select the correct job (enabling the tool) and the scan will be stored into ID#1.

Mask	ID type	Action		Reset ID			
				ID#1	ID#2	ID#3	ID#4
"VIN.....7..."	ID#1	Select Job#	1	No	No	No	No
"VIN.....8..."	ID#2	Select Job#	2	No	No	No	No
"VIN.....9..."	ID#3	Select Job#	3	No	No	No	No

The tool enable/disable will be controlled by the job settings; the correct job will be selected by the barcode scan. The "ID Required to Enable the Tool" feature does not need to be utilized.

Required Identifiers for Tool Enable			
ID#1	ID#2	ID#3	ID#4
No	No	No	No

These settings are irrelevant since the only way to enable the tool is with a new job and the only way to select a new job is to scan a new barcode.

Reset Identifiers on Job Complete			
ID#1	ID#2	ID#3	ID#4
Yes	No	No	No

Examples

This is what the 'Operator Scans' example looks like once set up in the Barcode Configuration Screen (see "4.5.7 Bar Code Setup" on page 26).

Airbag Install

The customer wants to track the serial number of each airbag being installed, as well as the operator installing it. When the operator reports to the station, they will scan their employee ID. When the vehicle comes into the station, the operator scans the VIN of the vehicle and the serial number of the airbag. Once all three scans are received, the tool is enabled. Once the correct number of fasteners are installed, the tool is disabled by the job settings. From that point, the operator only needs to scan the vehicle and the airbag to enable the tool.

Setup

We will assign the employee ID to ID#1, the vehicle VIN to ID#2, and the airbag serial number to ID#3. Scanning a new employee ID will reset the other IDs and force a scan of the vehicle VIN and airbag serial number. The scan of the vehicle VIN will also select the correct job number.

Mask	ID type	Action	Reset ID			
			ID#1	ID#2	ID#3	ID#4
"EMP...."	ID#1	None	No	Yes	Yes	No
"VIN....."	ID#2	Select Job#	1	No	No	No
"SN....."	ID#3	None	No	No	No	No

Once all three scans are received, the tool will be enabled.

Required Identifiers for Tool Enable			
ID#1	ID#2	ID#3	ID#4
Yes	Yes	Yes	No







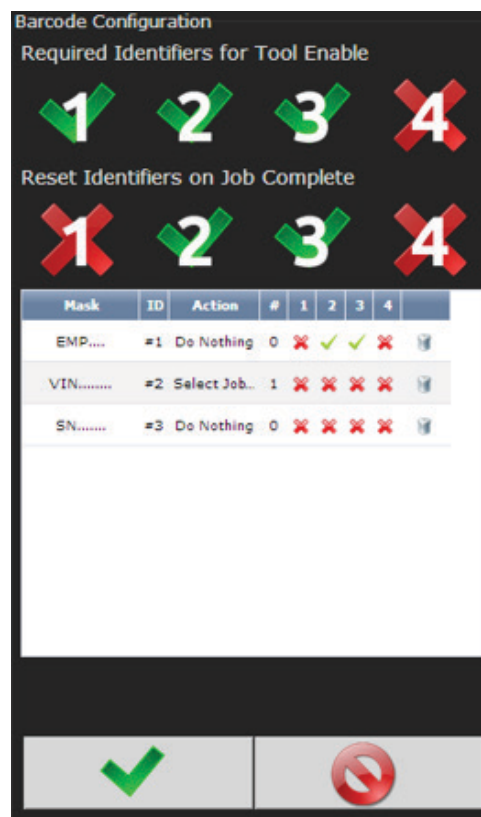









When job is complete, the vehicle VIN will be reset and the airbag serial number, but not the employee ID; this way subsequent vehicles will only require a VIN and S/N to enable tool.







Reset Identifiers on Job Complete			
ID#1	ID#2	ID#3	ID#4
No	Yes	Yes	No

This is what the Airbag Install example looks like set up in the Barcode Configuration Screen (see "4.5.7 Bar Code Setup" on page 26).















6. Icons Defined











Icon	Description	Function	Where Used
	Home Navigation Button	Navigate to the main menu ("HOME") screen.	All screens except for edit screens.
	Run Navigation Button	Navigate to the Run Screen.	All screens except for edit screens.
	Run Screen Select Buttons	Switch between the different run screen pages.	Run Screen
	Go Back Button	Navigate to one menu level back.	All screens except for edit screens.
	Accept Changes Button	Accept the changes made and return to the parent screen.	Edit screens
	Cancel Changes Button	Reject the changes made and return to the parent screen.	Edit screens
	Add New Button	Add a new item (Pset, Stage, Job, and other).	PSet and Job edit screens.
	Edit Button	Edit selected Item.	PSet and Job edit screens.
	Move Up and Down Buttons	Move selected item up or down in the sequence order.	PSet and Job edit screens.
	Copy Button	Copy selected Items	PSet, Job, and other edit screens.
	Delete Button	Remove or un-assign selected items.	Edit and list view screens.
	Filter Button	Filter Items in a list or table.	List view screens
	Save Button	Save selected item to file.	List view screens
	Select Columns Button	Allows customization of columns shown on the Results Screen.	Results Screen
	Fault Indicator	Fault exists that is preventing the tool from running (can be pressed for more Info).	Run Screen
	Invalid PSet Indicator	Selected Pset does not exist or is not valid.	Run Screen

Icon	Description	Function	Where Used
	Barcode Scan Required Indicator	A barcode is required to enable the tool.	Run Screen
	Job Complete Indicator	Job is complete.	Run Screen
	Lock on Reject (LOR)	Lock tool on rejected fastener.	Run Screen
	Disassembly	A disassembly event has been detected.	Run Screen
	Job Reset Complete	Reset Job has finished. Results from last successful rundown of a job are cleared.	Add New Job Screen
	Scan	Search for accessories on the network	Add Accessories Screen

7. Stop Codes

If a Stop condition is detected that prevents the tool from running, a code will appear on the LED display. Any active stop conditions are also displayed on the RUN screen.

Code	Icon	Description
IO		Stopped or Disabled from Physical 24 volt IO input
ABUS		Stopped or Disabled from ANYBUS
MODB		Stopped or Disabled from Modbus
EIP		Stopped or Disabled from Ethernet IP
RTU		Stopped or Disabled from Modbus RTU
OP		Stopped or Disabled from Open Protocol
OP		Lost Open Protocol Connection
REV		Disassembly Disabled
ARM		Tool Requires Arming – MFB button configured to enable the tool to run.
JOB		Job Sequence Complete
JOB		Job Complete
JOB		XML Count Complete
LOR		Locked on Reject

Code	Icon	Description
BRCD		Bar Code ID scan required to enable tool
SRVC		Tool Disabled For Service - Tool service or calibration interval has expired
INVP		Invalid PSet - Parameter set number for a non-existent Pset has been selected to run. Most likely via one of the following methods: <ul style="list-style-type: none"> ○ Job ○ MFB ○ I/O
INVP		PSet outside of Job - Parameter set number outside of the job has been selected. Most likely via one of the following methods: <ul style="list-style-type: none"> ○ MFB ○ I/O
INVJ		Invalid Job - Job number for a non-existent Job has been selected to run. Most likely via one of the following methods: <ul style="list-style-type: none"> ○ MFB ○ I/O
PSET		PSet Mismatch
SPND		Spindle Not Configured – Spindle selected to run from a Multi-Spindle Job has not been configured
NET		XML Disconnected
XML		Stop from XML
NOK		XML Max Rejects Exceeded
FLT		Controller Fault - Error has been detected. See fault code list for details

8. Error Codes

If an error condition is detected that prevents the tool from running, a fault code will appear on the LED display. Any active faults are also displayed on GUI RUN screen. Fault history can be viewed in the Controller Error Log.

Gen4 Common Hardware Fault Codes

Code	Fault Type	Description	Possible Causes
Gen IV Common Hardware Fault codes			
FH17	1.8vdc MB out of tolerance	Main board 1.8 bus voltage exceeds electrical limits	<ul style="list-style-type: none"> Faulty Controller main board or other Controller electronics
FH18	1.8vdc SOM out of tolerance	System on Module 1.8 bus voltage exceeds electrical limits	<ul style="list-style-type: none"> Faulty Controller main board or other Controller electronics
FH19	3.3vdc out of tolerance	Main board 3.3 bus voltage exceeds electrical limits	<ul style="list-style-type: none"> Faulty Controller main board or other Controller electronics
FH20	5vdc out of tolerance	5 Volt bus voltage out of range	<ul style="list-style-type: none"> Faulty power supply or wiring Faulty Controller main board or other Controller electronics
FH21	9vdc out of tolerance	9 Volt bus voltage out of range	<ul style="list-style-type: none"> Faulty power supply or wiring Faulty Controller main board or other Controller electronics Faulty tool cable Faulty tool electronics or wiring
FH22	24 volt level low	24 Volt I/O power not detected	<ul style="list-style-type: none"> Faulty power supply or wiring Short or other problem with external connections to the 24Volt I/O port.
FH23	Controller temp high	Controller's internal temperature exceeds limit	<ul style="list-style-type: none"> Ambient air temperature exceeds rating of Controller
FH24	+15vdc out of tolerance	+15 Volt bus voltage out of range	<ul style="list-style-type: none"> Faulty power supply or wiring Faulty Controller main board or other Controller electronics Faulty tool cable Faulty tool electronics or wiring
FH25	-15vdc out of tolerance	-15 Volt bus voltage out of range	<ul style="list-style-type: none"> Faulty power supply or wiring Faulty Controller main board or other Controller electronics Faulty tool cable Faulty tool electronics or wiring
FH32	Processor Fault	RTOS processor not communicating with the Application processor	<ul style="list-style-type: none"> Faulty mainboard electronics RTOS processor firmware corrupted or not loaded Faulty SOM board or connector
ICC (URYU UCX-AF Pulse Tool) Specific Fault Codes			
FP01	Torque signal out of Range	Tool torque signal voltage is beyond electrical limits	<ul style="list-style-type: none"> Tool not connected Faulty tool cable Faulty transducer Transducer electronics not calibrated Faulty tool/controller electronics or wiring
FP02	Torque tare value out of range	Tool torque signal no load voltage is out of range	<ul style="list-style-type: none"> Faulty tool cable Transducer electronics significantly out of calibration Faulty transducer
FP03	Torque Cal signal out of Range	Tool does not respond to the full scale voltage CAL single	<ul style="list-style-type: none"> Tool not connected Faulty tool cable Faulty transducer Transducer electronics not calibrated Faulty tool/controller electronics or wiring
FP04	Tool Not Connected	Tool communication timeout	<ul style="list-style-type: none"> Tool not connected Faulty tool cable Faulty tool electronics or wiring Tool firmware may require update
FP05	Tool Fault	The tool detects a problem	<ul style="list-style-type: none"> Tool is overheated and needs to cool down Faulty tool electronics or wiring

9. 24 Volt I/O

Port Pinout and Diagrams

An I/O wiring adapter kit is available (Part #27348) from AIMCO to make connection to I/O port on the controller easier. Contact your AIMCO Sales Representative for ordering information. Toll Free: 1-800-852-1368.

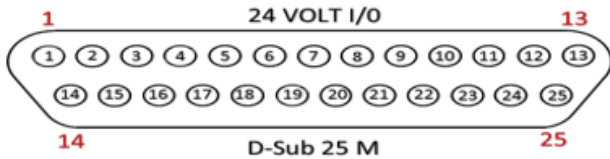

Pin #	Function	Default Assignment
1	Output 1	NOK/Timed
2	Output 2	OK
3	Output 3	In Cycle
4	Output 4	Torque High
5	Outputs 1-4 common	
6	Input 1	Start
7	Input 2	Reverse
8	Input 3	Disable Tool
9	Input 4	PSet Bit 1
10	Input 5	PSet Bit 2
11	Input 6	PSet Bit 3
12	Input 7	Reset Job
13	Input 8	Stop
14	Output 5	Torque Low
15	Output 6	Angle High
16	Output 7	Angle Low
17	Output 8	Job Complete
18	Outputs 5-8 common	
19	N/C	
20	N/C	
21	24 V Return	
22	24 V Return	
23	+24 Vdc	
24	+24 Vdc	
25	+24 Vdc	

NOTE: The Default Assignments in Table above are factory defaults and can be changed. See "10. Assignable I/O" on page 43.

24 Volt I/O Connections

Turn off system before connecting to the LOGIC I/O port. There may be risk of damaging the controller.

- **24Vdc Supply:** The internal 24Vdc power can supply up to 1 amp.
- **Inputs:** Inputs are a sinking configuration with the common connected to the ground pins. 24Vdc is logic ON and 0Vdc is logic OFF.
- **Outputs:** Outputs are normally open relay contacts. The relays are rated for 24Vdc, 1 amp.

NOTE: If Outputs are driving an inductive load, such as a solenoid or large relay, it is recommended to add a diode in parallel with the load to prevent voltage surges.

LOGIC I/O INPUT CONNECTION EXAMPLE

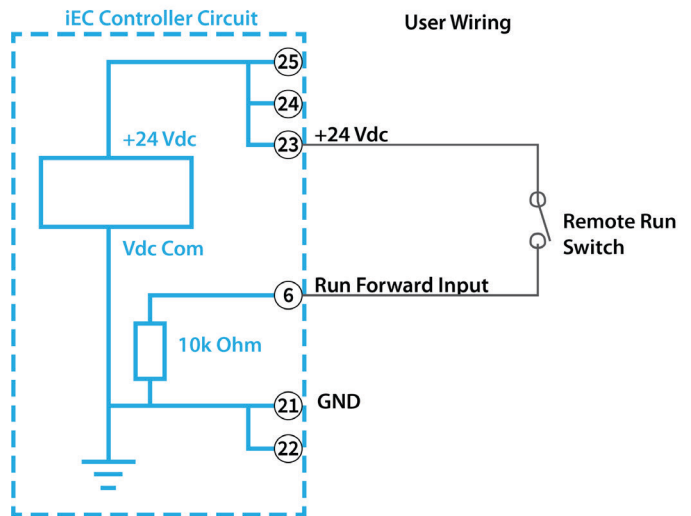

LOGIC I/O OUTPUT CONNECTION EXAMPLE

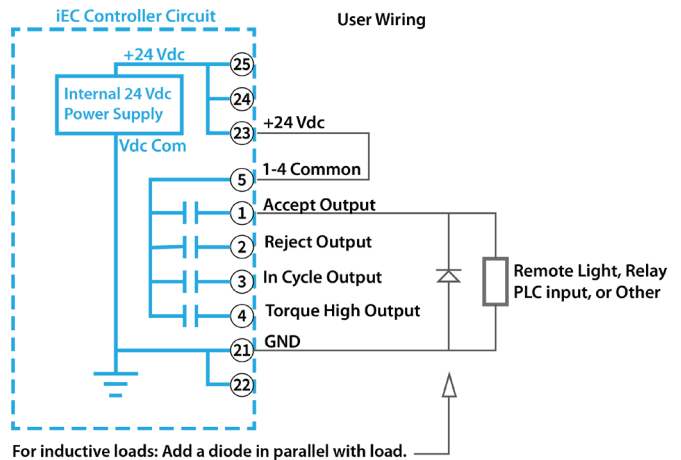

For inductive loads: Add a diode in parallel with load.

Importing I/O on an iCC4

These instructions detail how to import IO into an iCC4 controller via the system port to modify the Anybus outputs.

1. Power on the controller
2. Insert the USB stick into a USB port
3. Connect to the controller via system port and web browser (default address 192.168.1.4)
4. Navigate to Advanced → Import Settings

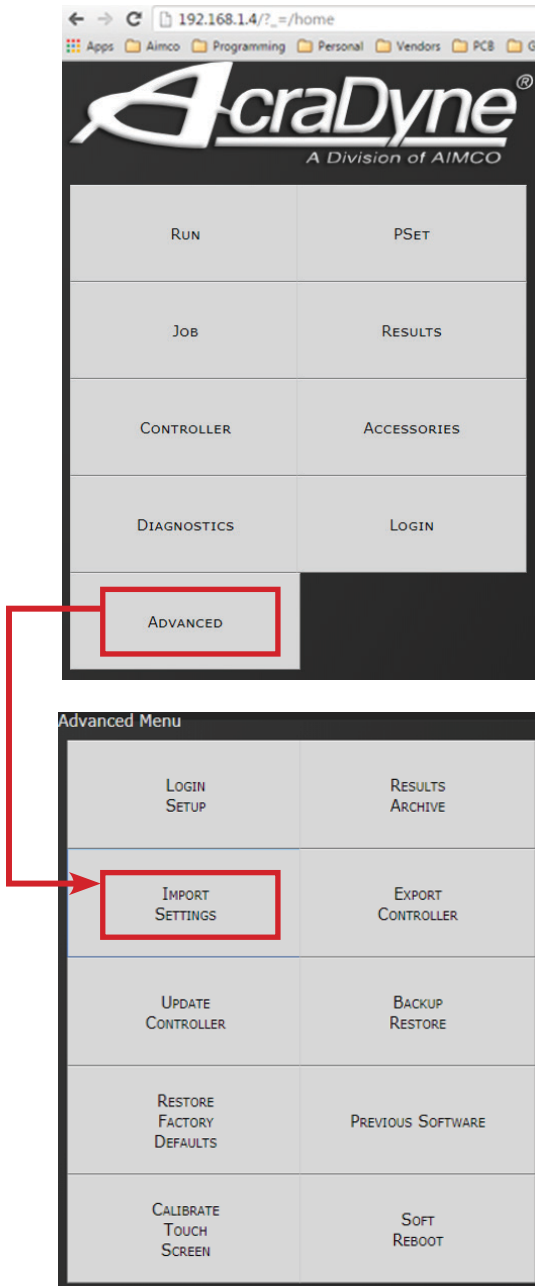

5. Choose file and select **ONLY I/O**

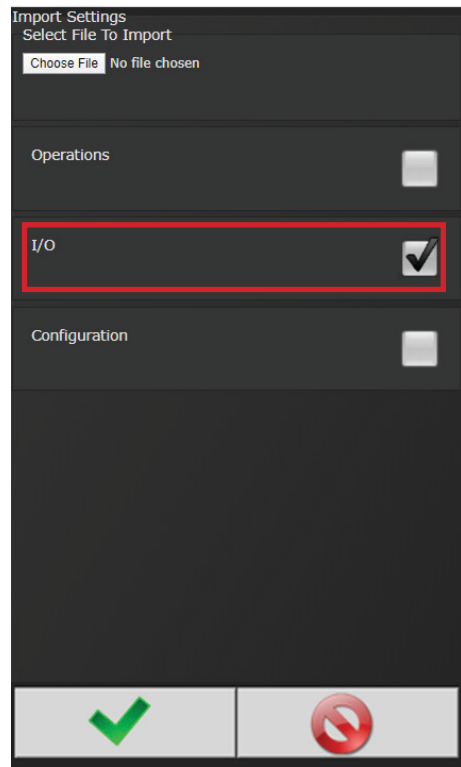

6. Click OK
7. Click OK in the Confirmation dialog box
8. The controller will restart
9. Verify the Anybus outputs.
 - a. Navigate to Controller → IO → Anybus Outputs
 - b. Click on the first row of element #1 and verify it is set as 'Running Job Number', Bit 0, Bits 8, Start at 0.
 - c. Click on element #4 and verify it is set as "Torque (x100)", Bit 0, Bits 16



10. Assignable I/O

The Gen IV controller supports assignable I/O.

Buses: The controller is divided up into buses. Each bus has a set of inputs and a set of outputs. Currently the controller supports the following buses.

Bus Number	Bus
1	Physical I/O
2	Fieldbus (Anybus module) I/O
3	Modbus TCP
4	Ethernet/IP

All assignments have a bus, element, and bit configuration to define its location in the system. The bus value needs to be set from the list above. The element and bit define the location in the bus. The first element on the bus is 0 and goes up the last legal element for the given bus. The bits in each element is referenced from 0(LSB) to 31(MSB).

10.1 Inputs

All input assignments have a Bus, Element, and Bit configuration to define its location in the system. Along with the basic configuration many also have other configuration(s) that allow its behavior to be modified to suit the application.

	Supported Feature						Controllers					
	Bus	Element	Bit 0-31	Polarity N.O./N.C.	Width	Offset	iEC	iAC	iPC	iBC	iBC-Z	iCC
Do Nothing	√	√	√				√	√	√	√	√	√
Start	√	√	√	√			√					
Stop	√	√	√	√			√	√	√	√		√
Reverse	√	√	√	√			√					
Disable	√	√	√	√			√	√	√			√
Reset Job	√	√	√	√			√	√	√	√	√	√
Select PSet	√	√	√		√	√	√	√	√	√		√
Select Job	√	√	√		√	√	√	√	√	√	√	√
Select Job Sequence	√	√	√		√	√	√	√	√	√	√	√
Disable Assembly	√	√	√	√			√					
Set ID	√	√	√		√		√	√	√	√	√	√
Set ID (word swap)	√	√	√		√		√	√	√	√	√	√
Set Date/Time	√	√	√		√		√	√	√	√	√	√
Set Date/Time (word swap)	√	√	√		√		√	√	√	√	√	√
Verify PSet	√	√	√		√	√	√	√	√	√	√	√
Clear Results	√	√	√	√			√	√	√	√	√	√
Log Change	√	√	√		√	√	√	√	√	√	√	√
Decrement Batch	√	√	√	√			√	√	√	√	√	√
Increment Batch	√	√	√	√			√	√	√	√	√	√
Click Wrench	√	√	√	√			√	√	√	√	√	√
Click Wrench NOK	√	√	√	√			√	√	√	√	√	√
Bypass Stops	√	√	√	√			√	√	√	√	√	√
Verify Job Sequence	√	√	√		√	√	√	√	√	√	√	√
ASCII ID	√	√					√	√	√	√	√	√
Abort Job	√	√	√	√			√	√	√	√		√
Remote Start	√	√	√	√			√					
Remove Lock on Reject	√	√	√	√			√	√	√	√		√
Dual Start Interlocked	√	√	√	√			√					
Decrement Job	√	√	√	√			√	√	√	√	√	√
Increment Job	√	√	√	√			√	√	√	√	√	√
Decrement PSet	√	√	√	√			√	√	√	√	√	√
Increment PSet	√	√	√	√			√	√	√	√	√	√
Decrement Job Sequence	√	√	√	√			√	√	√	√	√	√
Increment Job Sequence	√	√	√	√			√	√	√	√	√	√
Set Tool Home Position	√	√	√	√			√					

10.1.1 Polarity

When the polarity is set to N.O. the input is considered active high (24vdc for physical inputs and logic 1 for all network type buses). When the polarity is set to N.C. the input is considered active low (0vdc for physical inputs and logic 0 for all network type buses).

10.1.2 Width and Offset

For multiple bit inputs (for example "Select PSet") the width variable defines the number of bits the assignment will read for its input. This allows the input size to be restricted to a few bits saving space for other assignments.

The offset variable allows a fixed value to be added to the read value.

For example to use bits 4 & 5 of the physical inputs to select parameter sets 1-4 the assignment would look like...

Select PSet		
Bus	1	For the physical bus
Element	0	For the first element on the bus
Bit	4	For the starting bit location
Width	2	To span the two bits 4 & 5
Offset	1	Adding 1 to the read input value so we get... Binary 00 = 1 Binary 01 = 2 Binary 10 = 3 Binary 11 = 4

10.1.3 Input Assignments

Do Nothing	Bus	Element	Bit 0-32	Polarity N.O./N.C.	Width	Offset
	√	√	√			

The "Do Nothing" assignment will run do nothing if it is active or inactive.

Start	Bus	Element	Bit 0-32	Polarity N.O./N.C.	Width	Offset
	√	√	√	√		

The "Start" assignment will run the tool while the input is active. Start is available for the Physical I/O bus only.

Stop	Bus	Element	Bit 0-32	Polarity N.O./N.C.	Width	Offset
	√	√	√	√		

The "Stop" assignment will stop the tool if it is running and prevent it from being started.

Reverse	Bus	Element	Bit 0-32	Polarity N.O./N.C.	Width	Offset
	√	√	√	√		

The "Reverse" will put the controller in disassembly mode while the input is active.

Disable	Bus	Element	Bit 0-32	Polarity N.O./N.C.	Width	Offset
	√	√	√	√		

The "Disable" will disable the tool while the input is active. It will not stop a fastening cycle that is progress.

Reset Job	Bus	Element	Bit 0-32	Polarity N.O./N.C.	Width	Offset
	√	√	√	√		

On the transition of inactive to active the "Reset Job" assignment will reset the active job.

Select PSet	Bus	Element	Bit 0-32	Polarity N.O./N.C.	Width	Offset
	√	√	√		√	√

The "Select PSET" input will select the parameter set according to the input value. Uses the width parameter to define the number of input bits read. The minimum width is 1 and the maximum is 8. After the input is read the offset parameter will be added to the value to get the actual parameter set number. Selecting an invalid parameter set number will disable the tool.

Select Job	Bus	Element	Bit 0-32	Polarity N.O./N.C.	Width	Offset
	√	√	√		√	√

The "Select Job" input will select the job number according to the input value. Uses the width parameter to define the number of input bits read. The minimum width is 1 and the maximum is 8. After the input is read, the offset parameter will be added to the value to get the actual job number. Selecting an invalid job number will disable the tool.

Select Job Sequence	Bus	Element	Bit 0-32	Polarity N.O./N.C.	Width	Offset
	√	√	√		√	√

The "Select Job Sequence" input will select the job sequence number according to the input value. Uses the width parameter to define the number of input bits read. The minimum width is 1 and the maximum is 8. After the input is read, the offset parameter will be added to the value to get the actual job sequence number. Selecting an invalid job sequence number or a sequence that is already complete will disable the tool.

Disable Assembly	Bus	Element	Bit 0-32	Polarity N.O./N.C.	Width	Offset
	√	√	√	√		

The "Disable Assembly" assignment will disable the tool in the assembly direction. It will not disable the tool in disassembly or tube nut homing. It will not stop a fastening cycle that is progress.

Set ID	Bus	Element	Bit 0-32	Polarity N.O./N.C.	Width	Offset
	√	√	√		√	

The "Set ID" assignment will set the ID to an integer value of the input value. The width can be set from 1 to 32 bits. The input value will read as an integer value and an ASCII string with leading zeros will be produced and passed to the ID recognition system. The length of the string is based on the width of the assignment. The string will always be sized to accommodate the maximum value of the input. For example a width setting of 16 can have an integer value of 0-65535 so the produced ID would be "00000" to "65535" (always five character long).

Width setting	Length of ID string	ID value
1 - 3	1	"0" - "n"
4 - 6	2	"00" - "nn"
7 - 9	3	"000" - "nnn"
10 - 13	4	"0000" - "nnnn"
14 - 16	5	"00000" - "nnnnn"
17 - 19	6	"000000" - "nnnnnn"
20 - 23	7	"0000000" - "nnnnnnn"
24 - 26	8	"00000000" - "nnnnnnnn"
27 - 29	9	"000000000" - "nnnnnnnnn"
30 - 32	10	"0000000000" - "nnnnnnnnnn"

Set ID (word swap)	Bus	Element	Bit 0-32	Polarity N.O./N.C.	Width	Offset
	√	√	√		√	

The "Set ID (word swap)" assignment is the same as the "Set ID" assignment except the high and low words (16bit) are swapped prior to evaluation. This is to correct the mixed endianness of some PLC. See the "Set ID" for behavior.

Set Date/Time	Bus	Element	Bit 0-32	Polarity N.O./N.C.	Width	Offset
	√	√	√		√	

The "Set Date/Time" assignment will set the date and time of the controller. The width can be set from 1 to 32 bits but should always be set to 32 to get the correct results. The input value will be read as the number of seconds since 00:00:00 January 1, 1970 (POSIX time or Epoch time). If the input value changes and it is non-zero the date and time of the controller will be set to the new value.

Set Date/Time (word swap)	Bus	Element	Bit 0-32	Polarity N.O./N.C.	Width	Offset
	√	√	√		√	

The "Set Date/Time (word swap)" assignment is the same as the "Set Date/Time" assignment except the high and low words (16bit) are swapped prior to evaluation. This is to correct the mixed endianness of some PLC. See the "Set Date/Time" for behavior.

Verify PSet	Bus	Element	Bit 0-32	Polarity N.O./N.C.	Width	Offset
	√	√	√		√	√

The "Verify PSET" input will compare the current parameter set to the input value. Uses the width parameter to define the number of input bits read. The minimum width is 1 and the maximum is 8. After the input is read, the offset parameter will be added to the value to get the actual parameter set number. If the parameter set input value does not match the current parameter of the controller the tool will be disabled.

Clear Results	Bus	Element	Bit 0-32	Polarity N.O./N.C.	Width	Offset
	√	√	√	√		

The "Clear Results" assignment will clear the latest results outputs (Ok, Nok, etc.) on the same bus.

Log Change	Bus	Element	Bit 0-32	Polarity N.O./N.C.	Width	Offset
	√	√	√		√	√

The "Log Change" assignment will add entries to the controller event log when the input changes.

Decrement Batch	Bus	Element	Bit 0-32	Polarity N.O./N.C.	Width	Offset
	√	√	√	√		

The "Decrement Batch" assignment will remove the latest OK rundown from the current running JOB. This will cause the JOB count to be reduced by one.

Increment Batch	Bus	Element	Bit 0-32	Polarity N.O./N.C.	Width	Offset
	√	√	√	√		

The "Increment Batch" assignment will insert a manual rundown into the current sequence of the current JOB. This will cause the JOB count to increment by one.

Click Wrench	Bus	Element	Bit 0-32	Polarity N.O./N.C.	Width	Offset
	√	√	√	√		

The "Click Wrench" assignment is the same as "Increment Batch" with the addition of a programmable torque value.

Click Wrench NOK	Bus	Element	Bit 0-32	Polarity N.O./N.C.	Width	Offset
	√	√	√	√		

The "Click Wrench NOK" assignment is the same as "Click Wrench," but the inserted manual rundown always reports a torque of 0.

Bypass Stops	Bus	Element	Bit 0-32	Polarity N.O./N.C.	Width	Offset
	√	√	√	√		

The "Bypass Stops" assignment removes most stop conditions, allowing the tool to be ran in an override type condition. Hardware faults, stop and disable inputs are not removed.

Verify Job Sequence	Bus	Element	Bit 0-32	Polarity N.O./N.C.	Width	Offset
	√	√	√		√	√

The "Verify Job Sequence" input will compare the current Job sequence to the input value. Uses the width parameter to define the number of input bits read. The minimum width is 1 and the maximum is 8. After the input is read, the offset parameter will be added to the value to get the actual Job sequence number. If the Job sequence input value does not match the current Job sequence of the controller the tool will be disabled.

ASCII ID	Bus	Element	Bit 0-32	Polarity N.O./N.C.	Width	Offset
	√	√				

The "ASCII ID" assignment will set the ID to the of the input (ASCII) value. This assignment consumes the entire element so the Bit is not used. It also has a length parameter to set the length of the input in bytes. The input value will be passed directly to the ID recognition system.

Abort Job	Bus	Element	Bit 0-32	Polarity N.O./N.C.	Width	Offset
	√	√	√	√		

The "Abort Job" assignment aborts the job and disables the tool. A job reset is required to enable the tool for the next job.

Remote Start	Bus	Element	Bit 0-32	Polarity N.O./N.C.	Width	Offset
	√	√	√	√		

The "Remote Start" assignment will run the tool while the input is active. Remote Start is available for non-physical I/O buses.

Remove Lock on Reject	Bus	Element	Bit 0-32	Polarity N.O./N.C.	Width	Offset
	√	√	√	√		

The "Remove Lock on Reject" assignment unlocks the tool if locked on reject, re-enabling the tool.

Dual Start Interlocked	Bus	Element	Bit 0-32	Polarity N.O./N.C.	Width	Offset
	√	√	√	√		

The "Dual Start Interlocked" assignment will run the tool if the interlock conditions are met. Dual Start Interlock is available for the Physical IO bus only. The Dual Start Interlocked input works in combination with the Physical input assigned to the 'Start' input. The Dual Start Interlocked is only available for iEC controllers.

Setup

- Only 1 Start Input and 1 Dual Start Interlocked Input should be assigned.
- Controller->Tool Setup -> Start Input Configuration:
 - The Start Input Source Must be set to 'Start From IO'.
 - Latching throttle is disabled for Dual Interlocked Start.

Dual Start Interlocked - Operation

- The tool will not run unless both inputs are activated within two seconds of each other.
- If the two second timer times out, both inputs must be deactivated to reset the timer.
- If either input is deactivated the tool stops.
- To restart the tool, both inputs must be deactivated then reactivated within two seconds of each other.

Tubenut Tool Homing Exceptions for Dual Start Interlocked functionality

- If controller's tubenut homing configuration is set to RELEASE:
 - Deactivating either, or both, of the inputs will initiate the homing sequence.
 - Homing will continue until sequence is complete.
- If controller's tubenut homing configuration is set to RELEASE AND REPRESS:
 - Deactivating either of the inputs, then activating both inputs will initiate the homing sequence.
 - Homing will continue while both inputs are active.
 - If either input is deactivated, before homing is complete, the tool will stop, and homing will pause until both inputs are reactivated.
 - To restart tool, after homing is complete, both inputs must be deactivated, then reactivated within two seconds of each other.

Decrement Job	Bus	Element	Bit 0-32	Polarity N.O./N.C.	Width	Offset
	√	√	√	√		
<p>The "Decrement Job" assignment will decrement the Job Number, selecting the last job if decrementing past the first one.</p>						
Increment Job	Bus	Element	Bit 0-32	Polarity N.O./N.C.	Width	Offset
	√	√	√	√		
<p>The "Increment Job" assignment will increment the Job Number, selecting the first job if incrementing past the last one.</p>						
Decrement PSet	Bus	Element	Bit 0-32	Polarity N.O./N.C.	Width	Offset
	√	√	√	√		
<p>The "Decrement PSet" assignment will decrement the PSet Number, selecting the last PSet if decrementing past the first one.</p>						
Increment PSet	Bus	Element	Bit 0-32	Polarity N.O./N.C.	Width	Offset
	√	√	√	√		
<p>The "Increment PSet" assignment will increment the PSet Number, selecting the first PSet if incrementing past the last one.</p>						
Decrement Job Sequence	Bus	Element	Bit 0-32	Polarity N.O./N.C.	Width	Offset
	√	√	√	√		
<p>The "Decrement Job Sequence" assignment will decrement the Job sequence, selecting the last job sequence if decrementing past the first one.</p>						
Increment Job Sequence	Bus	Element	Bit 0-32	Polarity N.O./N.C.	Width	Offset
	√	√	√	√		
<p>The "Increment Job Sequence" assignment will increment the Job sequence, selecting the first job if incrementing past the last one.</p>						
Click Wrench NOK	Bus	Element	Bit 0-32	Polarity N.O./N.C.	Width	Offset
	√	√	√	√		
<p>The "Click Wrench NOK" assignment is the same as "Click Wrench," but the inserted manual rundown always reports a torque of 0.</p>						

10.2 Outputs

All output assignments have a Bus, Element, and Bit configuration to define its location in the system. Along with the basic configuration many also have other configuration(s) that allow its behavior to be modified to suit the application.

	Supported Feature											Controller					
	Bus	Element	Bit 0-32	Polarity N.O./ N.C.	Mode Normal, Timed, Flashed	Time	Width	Offset	Input Bus	Input Element	Input Bit	iEC	iAC	iPC	iBC	iBC-Z	iCC
Ok	√	√	√	√	√							√	√	√	√	√	√
Nok	√	√	√	√	√							√	√	√	√	√	√
Torque Ok	√	√	√	√	√							√	√	√	√	√	√
Torque Nok	√	√	√	√	√							√	√	√	√	√	√
Low Torque	√	√	√	√	√							√	√	√	√	√	√
High Torque	√	√	√	√	√							√	√	√	√	√	√
Angle Ok	√	√	√	√	√							√	√	√	√	√	√
Angle Nok	√	√	√	√	√							√	√	√	√	√	√
Low Angle	√	√	√	√	√							√	√	√	√	√	√
High Angle	√	√	√	√	√							√	√	√	√	√	√
Fastening Complete	√	√	√	√	√							√	√	√	√	√	√
In Cycle	√	√	√	√	√							√	√	√			√
Fastening Aborted	√	√	√	√	√							√	√	√	√	√	√
Fastening Stopped	√	√	√	√	√							√	√	√	√	√	√
Batch Complete	√	√	√	√	√							√	√	√	√	√	√
Job Complete	√	√	√	√	√							√	√	√	√	√	√
Error	√	√	√	√	√							√	√	√	√	√	√
Tool Start Switch	√	√	√	√	√							√					
Tool Push to Start Switch	√	√	√	√	√							√					
Tool MFB	√	√	√	√	√							√					
Tool Enabled	√	√	√	√	√							√	√	√	√	√	√
Tool Running	√	√	√	√	√							√					
Service Indicator	√	√	√	√	√							√	√	√		√	√
ToolsNet Connected	√	√	√	√	√							√	√	√	√	√	√
Open Protocol Connected	√	√	√	√	√							√	√	√	√	√	√
PFCs Connected	√	√	√	√	√							√	√	√	√	√	√
Running PSet Number	√	√	√				√	√				√	√	√	√	√	√
Running Job Number	√	√	√				√	√				√	√	√	√	√	√
External Controlled	√	√	√						√	√	√	√	√	√	√	√	√
Tool In CCW	√	√	√	√	√							√					
Tool In CW	√	√	√	√	√							√					
Torque	√	√	√				√					√	√	√	√	√	√
Torque (x10)	√	√	√				√					√	√	√	√	√	√
Torque (x100)	√	√	√				√					√	√	√	√	√	√
Angle	√	√	√				√					√	√	√	√	√	√
Rundown Saved to FTP Server	√	√	√				√					√	√	√	√	√	√
Fastener Removed	√	√	√	√	√							√	√	√			√
Spindle Ok	√	√	√	√	√							√					
Spindle NOk	√	√	√	√	√							√					
Spindle Fastening Complete	√	√	√	√	√							√					
Pulses	√	√	√				√						√	√		√	√
Pulses High	√	√	√	√	√								√	√		√	√
Pulses Low	√	√	√	√	√								√	√		√	√
Pulses NOk	√	√	√	√	√								√	√		√	√
Pulses Ok	√	√	√	√	√								√	√		√	√
ON	√	√	√	√	√							√	√	√	√	√	√
Job Aborted	√	√	√	√	√							√	√	√	√		√
Tool In Use	√	√	√	√		√						√	√	√	√	√	√
Barcode Scanned	√	√	√	√								√	√	√	√	√	√
Start Trigger Active	√	√	√	√								√					
Tubenut Home	√	√	√	√	√							√					

10.2.1 Polarity

When the polarity is set to N.O. the output will be high when it is active (24vdc for physical outputs and logic 1 for all network type buses). When the polarity is set to N.C. the output will be low for active (0vdc for physical inputs and logic 0 for all network type buses).

10.2.2 Mode

Normal

In the "Normal" mode, the output will track the state of the assignment (while still observing the polarity setting). If the polarity is set N.O. and the assignment has an active output the output will be on and stay on till the assignment goes to inactive.

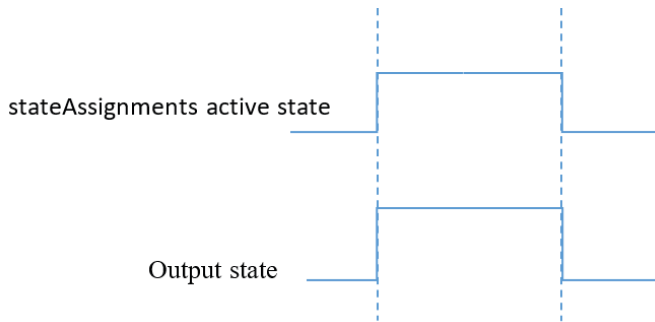

Figure 1: Normal Mode

Timed

In the "Timed" mode, the output will come on when the assignments state goes active and go off based on the time value or the assignment state going inactive (while still observing the polarity setting).

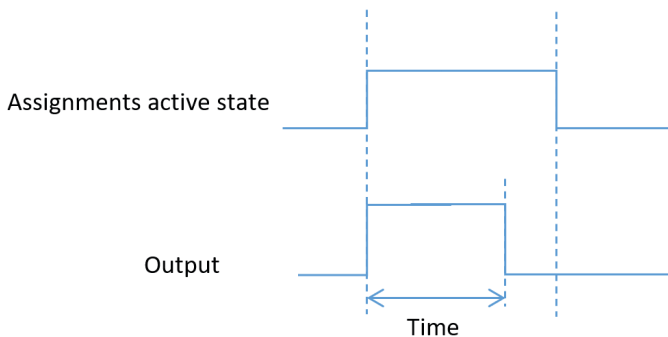

Figure 2 Timed Mode

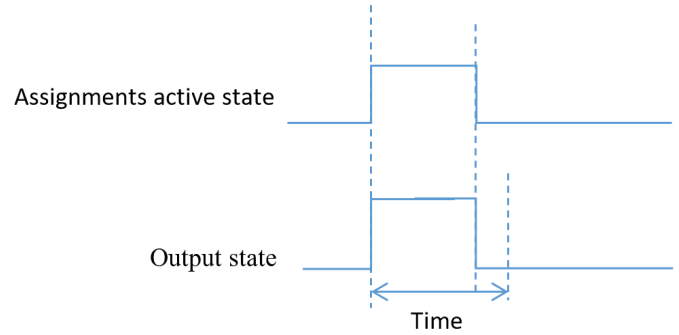

Figure 3: Timed Mode (assignment deactivates before time expires)

Flash

In the "flash" mode, the output will flash at the time rate while the assignments state is active (while still observing the polarity setting).

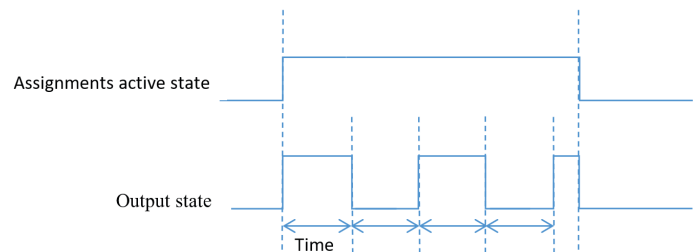

Figure 3 Flash Mode

Width and Offset

For multiple bit outputs (for example "Running PSet Number") the width variable defines the number of bits the assignment will output. This allows the output size to be restricted to a few bits saving space for other assignments.

The offset variable allows a fixed value to be added to the value before it is output.

For example to use bits 4 & 5 of the physical outputs to indicate the selected parameter set number 1-4 as binary 0-3 the assignment would look like...

Running PSet Number		
Bus	1	For the physical bus
Element	0	For the first element on the bus
Bit	4	For the starting bit location
Width	2	To span the two bits 4 & 5
Offset	-1	Adding -1 to the read input value so we get... 1 = Binary 00 2 = Binary 01 3 = Binary 10 4 = Binary 11

10.2.3 Output Assignments

OK	Bus	Element	Bit 0-32	Polarity N.O./N.C.	Mode: Normal, Timed, Flash	Time	Width	Offset	Input Bus	Input Element	Input Bit
	√	√	√	√	√						

The “Ok” output assignment will go active at the completion of an acceptable fastening. It will go inactive when the next fastening is started (the torque exceeds the threshold value) or a Job reset.

Nok	Bus	Element	Bit 0-32	Polarity N.O./N.C.	Mode: Normal, Timed, Flash	Time	Width	Offset	Input Bus	Input Element	Input Bit
	√	√	√	√	√						

The “Nok” output assignment will go active at the completion of an unacceptable fastening. It will go inactive when the next fastening is started (the torque exceeds the threshold value) or a Job reset.

Torque Ok	Bus	Element	Bit 0-32	Polarity N.O./N.C.	Mode: Normal, Timed, Flash	Time	Width	Offset	Input Bus	Input Element	Input Bit
	√	√	√	√	√						

The “Torque Ok” output assignment will go active at the completion of a fastening that has an acceptable torque value. It will go inactive when the next fastening is started (the torque exceeds the threshold value) or a Job reset.

Torque Nok	Bus	Element	Bit 0-32	Polarity N.O./N.C.	Mode: Normal, Timed, Flash	Time	Width	Offset	Input Bus	Input Element	Input Bit
	√	√	√	√	√						

The “Torque Nok” output assignment will go active at the completion of a fastening that has an unacceptable torque value. It will go inactive when the next fastening is started (the torque exceeds the threshold value) or a Job reset.

Low Torque	Bus	Element	Bit 0-32	Polarity N.O./N.C.	Mode: Normal, Timed, Flash	Time	Width	Offset	Input Bus	Input Element	Input Bit
	√	√	√	√	√						

The “Low Torque” output assignment will go active at the completion of a fastening that has a low torque results. It will go inactive when the next fastening is started (the torque exceeds the threshold value) or a Job reset.

High Torque	Bus	Element	Bit 0-32	Polarity N.O./N.C.	Mode: Normal, Timed, Flash	Time	Width	Offset	Input Bus	Input Element	Input Bit
	√	√	√	√	√						

The “High Torque” output assignment will go active at the completion of a fastening that has a high torque result. It will go inactive when the next fastening is started (the torque exceeds the threshold value) or a Job reset.

Angle Ok	Bus	Element	Bit 0-32	Polarity N.O./N.C.	Mode: Normal, Timed, Flash	Time	Width	Offset	Input Bus	Input Element	Input Bit
	√	√	√	√	√						

The “Angle Ok” output assignment will go active at the completion of a fastening that has an acceptable angle result. It will go inactive when the next fastening is started (the torque exceeds the threshold value) or a Job reset.

Angle Nok	Bus	Element	Bit 0-32	Polarity N.O./N.C.	Mode: Normal, Timed, Flash	Time	Width	Offset	Input Bus	Input Element	Input Bit
	√	√	√	√	√						

The “Angle Nok” output assignment will go active at the completion of a fastening that has an unacceptable angle result. It will go inactive when the next fastening is started (the torque exceeds the threshold value) or a Job reset.

Low Angle	Bus	Element	Bit 0-32	Polarity N.O./N.C.	Mode: Normal, Timed, Flash	Time	Width	Offset	Input Bus	Input Element	Input Bit
	√	√	√	√	√						

The “Low Angle” output assignment will go active at the completion of a fastening that has a low angle result. It will go inactive when the next fastening is started (the torque exceeds the threshold value) or a Job reset.

High Angle	Bus	Element	Bit 0-32	Polarity N.O./N.C.	Mode: Normal, Timed, Flash	Time	Width	Offset	Input Bus	Input Element	Input Bit
	√	√	√	√	√						

The “High Angle” output assignment will go active at the completion of a fastening that has a high angle result. It will go inactive when the next fastening is started (the torque exceeds the threshold value) or a Job reset.

Fastening Complete	Bus	Element	Bit 0-32	Polarity N.O./N.C.	Mode: Normal, Timed, Flash	Time	Width	Offset	Input Bus	Input Element	Input Bit
	√	√	√	√	√						

The “Fastening Complete” output assignment will go active at the completion of a fastening. It will go inactive when the next fastening is started (the torque exceeds the threshold value) or a Job reset.

In Cycle	Bus	Element	Bit 0-32	Polarity N.O./N.C.	Mode: Normal, Timed, Flash	Time	Width	Offset	Input Bus	Input Element	Input Bit
	√	√	√	√	√						

The “In Cycle” output assignment will go active at the start of the fastening cycle (the torque exceeds the threshold value). It will go inactive when the fastening cycle ends.

Fastening Aborted	Bus	Element	Bit 0-32	Polarity N.O./N.C.	Mode: Normal, Timed, Flash	Time	Width	Offset	Input Bus	Input Element	Input Bit
	√	√	√	√	√						

The “Fastening Aborted” output assignment will go active at the completion of a fastening that was aborted by the system. It will go inactive when the next fastening is started (the torque exceeds the threshold value) or a Job reset.

Fastening Stopped	Bus	Element	Bit 0-32	Polarity N.O./N.C.	Mode: Normal, Timed, Flash	Time	Width	Offset	Input Bus	Input Element	Input Bit
	√	√	√	√	√						

The “Fastening Stopped” output assignment will go active at the completion of a fastening that was stopped by the user. It will go inactive when the next fastening is started (the torque exceeds the threshold value) or a Job reset.

Batch Complete	Bus	Element	Bit 0-32	Polarity N.O./N.C.	Mode: Normal, Timed, Flash	Time	Width	Offset	Input Bus	Input Element	Input Bit
	√	√	√	√	√						

The “Batch Complete” output assignment will go active at the completion of a fastening that satisfies the bolt count of a Job sequence. It will go inactive when the next fastening is started (the torque exceeds the threshold value) or the job is reset.

Job Complete	Bus	Element	Bit 0-32	Polarity N.O./N.C.	Mode: Normal, Timed, Flash	Time	Width	Offset	Input Bus	Input Element	Input Bit
	√	√	√	√	√						

The “Job Complete” output assignment will go active at the completion of a fastening that satisfies all the sequences. It will go inactive when the next fastening is started (the torque exceeds the threshold value) or the job is reset.

Error	Bus	Element	Bit 0-32	Polarity N.O./N.C.	Mode: Normal, Timed, Flash	Time	Width	Offset	Input Bus	Input Element	Input Bit
	√	√	√	√	√						

The “Error” output assignment will be active while the controller has an error.

Tool Start Switch	Bus	Element	Bit 0-32	Polarity N.O./N.C.	Mode: Normal, Timed, Flash	Time	Width	Offset	Input Bus	Input Element	Input Bit
	√	√	√	√	√						

The “Tool Start Switch” output assignment will reflect the state of the tools start lever.

Tool Push to Start Switch	Bus	Element	Bit 0-32	Polarity N.O./N.C.	Mode: Normal, Timed, Flash	Time	Width	Offset	Input Bus	Input Element	Input Bit
	√	√	√	√	√						

The “Tool Push to Start Switch” output assignment will reflect the state of the tools push to start switch.

Tool MFB	Bus	Element	Bit 0-32	Polarity N.O./N.C.	Mode: Normal, Timed, Flash	Time	Width	Offset	Input Bus	Input Element	Input Bit
	√	√	√	√	√						

The “Tool MFB” output assignment will reflect the state of the tools multifunction button.

Tool Enabled	Bus	Element	Bit 0-32	Polarity N.O./N.C.	Mode: Normal, Timed, Flash	Time	Width	Offset	Input Bus	Input Element	Input Bit
	√	√	√	√	√						

The “Tool Enabled” output assignment will be active if the tool is enabled.

Tool Running	Bus	Element	Bit 0-32	Polarity N.O./N.C.	Mode: Normal, Timed, Flash	Time	Width	Offset	Input Bus	Input Element	Input Bit
	√	√	√	√	√						
The "Tool Running" output assignment will be active while the tool is running.											
Service Indicator	Bus	Element	Bit 0-32	Polarity N.O./N.C.	Mode: Normal, Timed, Flash	Time	Width	Offset	Input Bus	Input Element	Input Bit
	√	√	√	√	√						
The "Service Indicator" output assignment will be active if the system is in need of service.											
ToolsNet Connected	Bus	Element	Bit 0-32	Polarity N.O./N.C.	Mode: Normal, Timed, Flash	Time	Width	Offset	Input Bus	Input Element	Input Bit
	√	√	√	√	√						
The "ToolsNet Connected" output assignment will be active if the controller has an active connection to a ToolsNet server.											
Open Protocol Connected	Bus	Element	Bit 0-32	Polarity N.O./N.C.	Mode: Normal, Timed, Flash	Time	Width	Offset	Input Bus	Input Element	Input Bit
	√	√	√	√	√						
The "Open Protocol Connected" output assignment will be active if the controller has an active Open protocol connection.											
PFCS Connected	Bus	Element	Bit 0-32	Polarity N.O./N.C.	Mode: Normal, Timed, Flash	Time	Width	Offset	Input Bus	Input Element	Input Bit
	√	√	√	√	√						
The "PFCS Connected" output assignment will be active if the controller has an active PFCS connection.											
Running PSet Number	Bus	Element	Bit 0-32	Polarity N.O./N.C.	Mode: Normal, Timed, Flash	Time	Width	Offset	Input Bus	Input Element	Input Bit
	√	√	√				√	√			
The "Running PSet Number" output assignment will output the current PSet number.											
Running Job Number	Bus	Element	Bit 0-32	Polarity N.O./N.C.	Mode: Normal, Timed, Flash	Time	Width	Offset	Input Bus	Input Element	Input Bit
	√	√	√				√	√			
The "Running Job Number" output assignment will output the current Job number.											
External Controlled	Bus	Element	Bit 0-32	Polarity N.O./N.C.	Mode: Normal, Timed, Flash	Time	Width	Offset	Input Bus	Input Element	Input Bit
	√	√	√						√	√	√
The "External Controlled" output assignment will reflect the state of an input. Use the "Input Bus, "Input Element", and "Input Bit" to specify the input to reflect.											
Tool in CCW	Bus	Element	Bit 0-32	Polarity N.O./N.C.	Mode: Normal, Timed, Flash	Time	Width	Offset	Input Bus	Input Element	Input Bit
	√	√	√	√	√						
The "Tool In CCW" output assignment will be active if the tool is put into disassembly mode and inactive if the tool is in assembly mode.											
Tool in CW	Bus	Element	Bit 0-32	Polarity N.O./N.C.	Mode: Normal, Timed, Flash	Time	Width	Offset	Input Bus	Input Element	Input Bit
	√	√	√	√	√						
The "Tool In CW" output assignment will be active when the tool is in assembly mode and inactive if the tool is put into disassembly mode.											
Torque	Bus	Element	Bit 0-32	Polarity N.O./N.C.	Mode: Normal, Timed, Flash	Time	Width	Offset	Input Bus	Input Element	Input Bit
	√	√	√				√				
If Stage Default is selected, the "Torque" output assignment will output the final torque value of the most recent rundown. If a specific Stage is selected, the "Torque" output assignment will output the final torque value of the selected stage. In both cases, the value will be cleared to 0 at the start of a new fastening cycle or a Job reset. At the end of the fastening cycle the final torque will be truncated to an integer and output.											

Torque (x10)	Bus	Element	Bit 0-32	Polarity N.O./N.C.	Mode: Normal, Timed, Flash	Time	Width	Offset	Input Bus	Input Element	Input Bit
Torque (x10)	√	√	√				√				
<p>If Stage Default is selected, the "Torque (x10)" output assignment will output the final torque value of the most recent rundown. If a specific Stage is selected, the "Torque (x10)" output assignment will output the final torque value of the selected stage. In both cases, the value will be cleared to 0 at the start of a new fastening cycle or a Job reset. At the end of the fastening cycle the final torque will be multiplied by 10, truncated to an integer and output.</p>											
Torque (x100)	Bus	Element	Bit 0-32	Polarity N.O./N.C.	Mode: Normal, Timed, Flash	Time	Width	Offset	Input Bus	Input Element	Input Bit
Torque (x100)	√	√	√				√				
<p>If Stage Default is selected, the "Torque (x100)" output assignment will output the final torque value of the most recent rundown. If a specific Stage is selected, the "Torque (x100)" output assignment will output the final torque value of the selected stage. In both cases, the value will be cleared to 0 at the start of a new fastening cycle or a Job reset. At the end of the fastening cycle the final torque will be multiplied by 100, truncated to an integer and output.</p>											
Angle	Bus	Element	Bit 0-32	Polarity N.O./N.C.	Mode: Normal, Timed, Flash	Time	Width	Offset	Input Bus	Input Element	Input Bit
Angle	√	√	√				√				
<p>If Stage Default is selected, the "Angle" output assignment will output the final angle value of the most recent rundown. If a specific Stage is selected, the "Angle" output assignment will output the final angle value of the selected stage. In both cases, the value will be cleared to 0 at the start of a new fastening cycle or a Job reset.</p>											
Rundown Saved to FTP Server	Bus	Element	Bit 0-32	Polarity N.O./N.C.	Mode: Normal, Timed, Flash	Time	Width	Offset	Input Bus	Input Element	Input Bit
Rundown Saved to FTP Server	√	√	√				√				
<p>The "Rundown Saved to FTP Server" output assignment will output the ID of the last rundown that was saved to the FTP server.</p>											
Fastener Removed	Bus	Element	Bit 0-32	Polarity N.O./N.C.	Mode: Normal, Timed, Flash	Time	Width	Offset	Input Bus	Input Element	Input Bit
Fastener Removed	√	√	√	√	√						
<p>The "Fastener Removed" output assignment will go active when a fastener is removed by the operator. The controller must be configured to report disassembly for this output to work. It will go inactive when the next fastening is started (the torque exceeds the threshold value) or a Job reset.</p>											
Spindle OK	Bus	Element	Bit 0-32	Polarity N.O./N.C.	Mode: Normal, Timed, Flash	Time	Width	Offset	Input Bus	Input Element	Input Bit
Spindle OK	√	√	√	√	√						
<p>The "Spindle Ok" output assignment will go active at the completion of multi-spindle fastening if all spindles have an OK. It will go inactive when the next fastening is started (the torque exceeds the threshold value) or a Job reset.</p>											
Spindle NOk	Bus	Element	Bit 0-32	Polarity N.O./N.C.	Mode: Normal, Timed, Flash	Time	Width	Offset	Input Bus	Input Element	Input Bit
Spindle NOk	√	√	√	√	√						
<p>The "Spindle NOK" output assignment will go active at the completion of multi-spindle fastening if one or more of the spindles have an NOK. It will go inactive when the next fastening is started (the torque exceeds the threshold value) or a Job reset.</p>											
Spindle Fastening Complete	Bus	Element	Bit 0-32	Polarity N.O./N.C.	Mode: Normal, Timed, Flash	Time	Width	Offset	Input Bus	Input Element	Input Bit
Spindle Fastening Complete	√	√	√	√	√						
<p>The "Spindle Fastening Complete" output assignment will go active at the completion of multi-spindle fastening. It will go inactive when the next fastening is started (the torque exceeds the threshold value) or a Job reset.</p>											
Pulses	Bus	Element	Bit 0-32	Polarity N.O./N.C.	Mode: Normal, Timed, Flash	Time	Width	Offset	Input Bus	Input Element	Input Bit
Pulses	√	√	√				√				
<p>The "Pulses" output assignment will output the pulse count value of the most recent rundown. The value will be cleared to 0 at the start of a new fastening cycle or a Job reset.</p>											

	Bus	Element	Bit 0-32	Polarity N.O./N.C.	Mode: Normal, Timed, Flash	Time	Width	Offset	Input Bus	Input Element	Input Bit			
Pulses High	√	√	√	√	√									
<p>The "Pulses High" output assignment will go active at the completion of a fastening that has an pulse count that exceeds the high limit. It will go inactive when the next fastening is started (the torque exceeds the threshold value) or a Job reset.</p>														
Pulses Low	√	√	√	√	√									
<p>The "Pulses Low" output assignment will go active at the completion of a fastening that has an pulse count that falls below the low limit. It will go inactive when the next fastening is started (the torque exceeds the threshold value) or a Job reset.</p>														
Pulses NOK	√	√	√	√	√									
<p>The "Pulses NOK" output assignment will go active at the completion of a fastening that has an unacceptable pulse count. It will go inactive when the next fastening is started (the torque exceeds the threshold value) or a Job reset.</p>														
Pulses Ok	√	√	√	√	√									
<p>The "Pulses Ok" output assignment will go active at the completion of a fastening that has an acceptable pulse count. It will go inactive when the next fastening is started (the torque exceeds the threshold value) or a Job reset.</p>														
ON	√	√	√	√	√									
<p>The "ON" output assignment will be active when the controller is powered up and remains active until power down.</p>														
Job Aborted	√	√	√	√	√									
<p>The "Job Aborted" output assignment will go active if a Job is aborted. It will go inactive when the job is reset.</p>														
Tool In Use	√	√	√	√		√								
<p>The "Tool In Use" output assignment will go active when the trigger is pressed, whereupon a timer will restart. It will go inactive when the specified time is reached without becoming active in between.</p>														
Barcode Scanned	√	√	√	√										
<p>The "Barcode Scanned" output assignment will go active when a barcode is scanned. The ID # (1-4) will activate the corresponding bit, if it is covered by the number of bits configured. The maximum size is 4 bits. All bits will go inactive when a tool reaches the InCycle threshold of a rundown or when they are reset.</p>														
Start Trigger Active	√	√	√	√	√									
<p>The 'Start Trigger Active' assignment will reflect the state of the active Start Input configured to run the tool.</p> <p>Possible Start Inputs include:</p> <table style="width: 100%; border: none;"> <tr> <td style="border: none; vertical-align: top;"> <ul style="list-style-type: none"> • Start from IO <ul style="list-style-type: none"> ◦ Start ◦ Dual Start Interlocked </td> <td style="border: none; vertical-align: top;"> <ul style="list-style-type: none"> • Start from Tool Buttons <ul style="list-style-type: none"> ◦ Lever and/or PTS ◦ Dual Levers Interlocked </td> <td style="border: none; vertical-align: top;"> <ul style="list-style-type: none"> • Start from Master Tool • Start from Remote Start • Latched Throttle </td> </tr> </table> <p>Start Trigger Active is available for the iEC Controller Only.</p>												<ul style="list-style-type: none"> • Start from IO <ul style="list-style-type: none"> ◦ Start ◦ Dual Start Interlocked 	<ul style="list-style-type: none"> • Start from Tool Buttons <ul style="list-style-type: none"> ◦ Lever and/or PTS ◦ Dual Levers Interlocked 	<ul style="list-style-type: none"> • Start from Master Tool • Start from Remote Start • Latched Throttle
<ul style="list-style-type: none"> • Start from IO <ul style="list-style-type: none"> ◦ Start ◦ Dual Start Interlocked 	<ul style="list-style-type: none"> • Start from Tool Buttons <ul style="list-style-type: none"> ◦ Lever and/or PTS ◦ Dual Levers Interlocked 	<ul style="list-style-type: none"> • Start from Master Tool • Start from Remote Start • Latched Throttle 												
Tubenut Home	√	√	√	√	√									
<p>The 'Tubenut Home' assignment will go active if a Tubenut Tool is in the home position.</p>														

11. Controller Supported MIDs

Supported MID			
MID	Description	Revisions	Note
1	Communication start	1,2,3	
2	Communication start acknowledge	1,2,3	
3	Communication stop		
4	Command error		
5	Command accepted		
8	Application data subscribe		Support MID 900 curve data only
9	Application data unsubscribe		Support MID 900 curve data only
10	Parameter set ID upload request		
11	Parameter set ID upload reply		
12	Parameter set data upload request		
13	Parameter set data upload reply		Always returns a batch size of 0
14	Parameter set selected subscribe		
15	Parameter set selected		
16	Parameter set selected acknowledge		
17	Parameter set selected unsubscribe		
18	Select Parameter set		
19	Set Parameter set batch size		
20	Reset Parameter set batch counter		
30	Job ID upload request		
31	Job ID upload reply		
34	Job info subscribe		
35	Job info		
36	Job info acknowledge		
37	Job info unsubscribe		
38	Select Job		
39	Job restart		
40	Tool data upload request	1,2	
41	Tool data upload reply		
42	Disable tool		
43	Enable tool		
50	Vehicle ID number download request		
51	Vehicle ID number subscribe	1,2	
52	Vehicle ID number	1,2	Has an option to send w/without IDs
53	Vehicle ID number acknowledge		
54	Vehicle ID number unsubscribe		
60	Last tightening result data subscribe	1-6,999	
61	Last tightening result data		
62	Last tightening result data acknowledge		
63	Last tightening result data unsubscribe		
64	Old tightening result upload request		

Supported MID			
MID	Description	Revisions	Note
65	Old tightening result upload reply		
70	Alarm subscribe		
71	Alarm		
72	Alarm acknowledge		
73	Alarm unsubscribe		
76	Alarm status		
77	Alarm status acknowledge		
80	Read time upload request		
81	Read time upload reply		
82	Set time		
90	Multi spindle status subscribe		
91	Multi spindle status		
92	Multi spindle status acknowledge		
93	Multi spindle status unsubscribe		
100	Multi spindle results subscribe		
101	Multi spindle results		
102	Multi spindle results acknowledge		
103	Multi spindle results unsubscribe		
113	Flash green light on tool		
127	Abort Job		
128	Job batch increment		
129	Job batch decrement		
130	Job off		
150	Identifier download request		
157	Reset all Identifiers		
200	Set external controlled relays		Only supports 0 (off) and 1 (on)
210	Status external monitored inputs subscribe		
211	Status external monitored inputs		
212	Status external monitored inputs acknowledge		
213	Status external monitored inputs unsubscribe		
214	IO device status request	1,2	
215	IO device status reply		
216	Relay function subscribe		See supported relay functions below.
217	Relay function		
218	Relay function acknowledge		
219	Relay function unsubscribe		
241	User data subscribe		Out_1 - Pulse status (0= OK, 1 = Low, 2 = High)
242	User data		
243	User data acknowledge		
244	User data unsubscribe		Out_2 - Pulses Out_3 - Undefined Out_4 - Undefined
900	Trace data		Trace type 1 & 2 only (angle & torque)
9999	Keep alive open protocol communication		

Supported Relay Functions

Supported Relay Functions Number	Function
1	OK
2	NOK
5	Low Torque
6	High Torque
7	Low angle
8	High angle

Supported Relay Functions Number	Function
9	Cycle complete
10	Alarm
11	Batch NxOK
12	Job OK
19	Tool ready
20	Tool start switch

Supported Relay Functions Number	Function
21	Dir. switch = CW
22	Dir. switch = CCW
26	Tool running
145	Start Trigger Active
276	Cycle abort

12. Dimensions

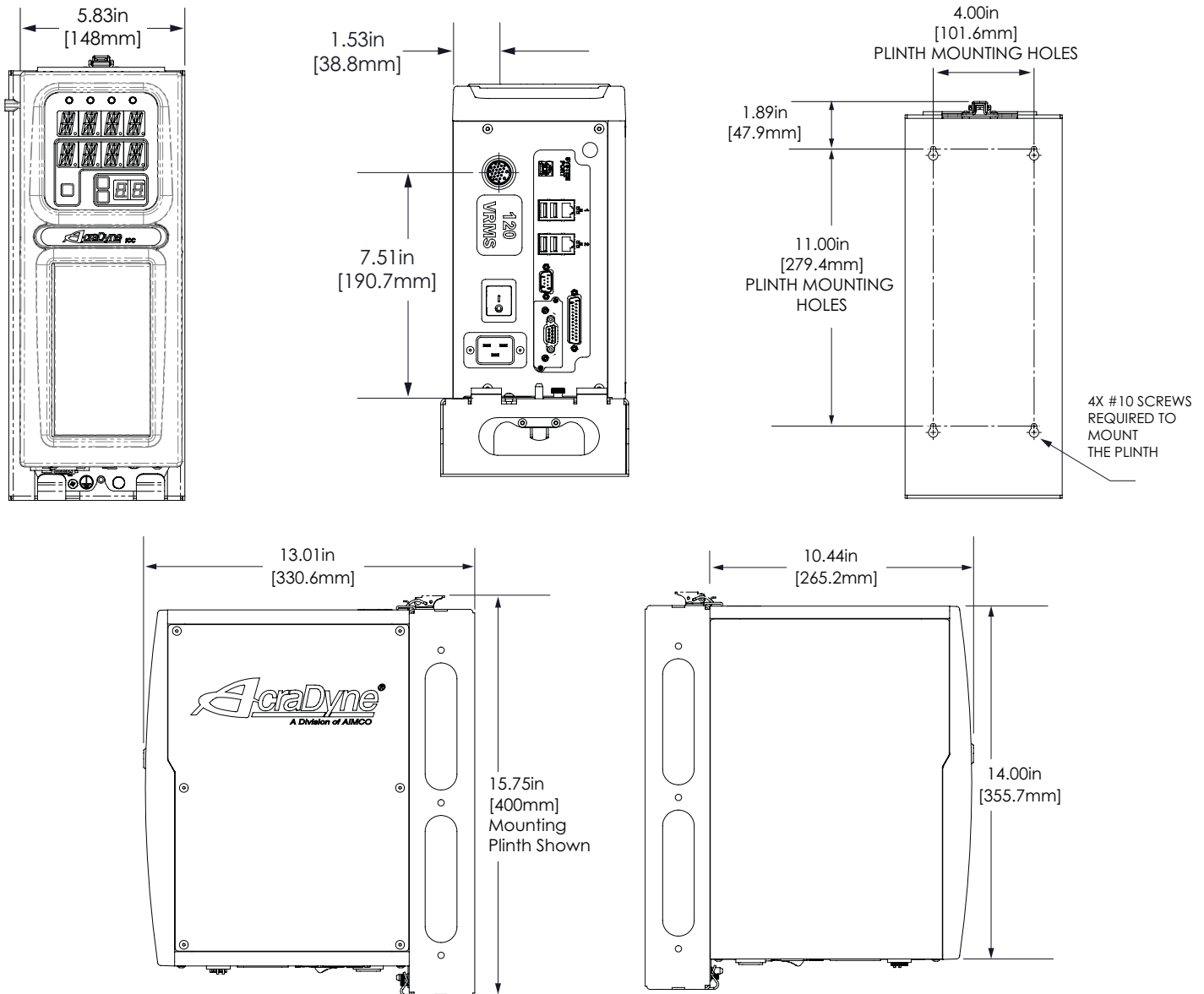

13. Specifications

Mechanical:

Dimensions	Width:	6.25 in	159 mm
	Height:	15.75 in	400 mm
	Depth:	12.5 in	316 mm
Weight:		11.9 lbs	5.4 kg

Operating Conditions:

Temperature:	32 to 122 °F (0 to 50 °C)
Humidity:	Non-condensing
Ingress Protection:	IP20

Electrical:

AC Power Source:	
120 VAC, 50/60 Hz	

Standards:

Safety Compliance:

IEC 61010-1
Safety requirements for electrical equipment for measurement, control, and laboratory use – Part 1: General requirements

IEC 61010-2
Safety requirements for electrical equipment for measurement, control, and laboratory use – Part 2-201: Particular requirements for control equipment

RoHs

Reduction of Hazardous Substances 2002/95/EC

Markings

14. Troubleshooting

Issue: LED Frozen Showing "Initializing"

Solution: The rear SD card containing the system UI may have become unseated. Turn off controller power. Depending on vintage, remove the label or cover plate to access the card slot. Gently depress the card and release to unseat it. Gently then press the card into the slot until feeling and hearing the locking click indicating it is secure. Replace the label or cover plate and power the controller back on.

Issue: System Port IP Connectivity using USB Cabling

Solution: In most cases, connectivity will be automatic when connection between the controller SYSTEM PORT and a PC USB Port are made. Confirmation of the connection is noted by the presence of a USB Ethernet/RNDIS Gadget in the PC Adapter list. Should this connection not be established, specific instructions are located at the product manuals page at <https://www.aimco-global.com/manuals> under the heading **System Port Connectivity Troubleshooting for PCs**.

15. AIMCO Warranty

NEW TOOL AND ACCESSORY WARRANTY

Any new tool or accessory branded with the AIMCO, URYU, AcraDyne or Eagle Industries name, and purchased from AIMCO, or through one of its authorized distributors or agents, is warranted to the original buyer against defects in materials and workmanship for a period of one (1) year* from date of delivery. Under the terms of this warranty, AIMCO will repair or replace any product or accessory warranted here under and returned freight prepaid proving to AIMCO's satisfaction to be defective as a result of workmanship or materials. In order to qualify for this warranty, written notice to AIMCO must be given immediately upon discovery of such defect, at which time AIMCO will issue an authorization to return the tool. The defective item must be promptly returned to an authorized AIMCO service center with all freight charges prepaid.

REPAIRED TOOL WARRANTY

Once a tool is beyond the new product warranty period as detailed above, AIMCO repairs are subject to the following warranty periods: pneumatic tools: 90 days*; electric tools and Acra-Feed: 90 days; battery tools: 30 days*; DC Electric tools: 90 days*

EXCLUSION FROM WARRANTY

This warranty is valid only on products purchased from AIMCO, or through its authorized distributors or agents. AIMCO shall have no obligation pursuant to the AIMCO Warranty with respect to any tools or accessories which in AIMCO's sole judgment have been altered, damaged, misused, abused, badly worn, lost or improperly maintained. This Warranty is null and void if the customer, or any other person other than an authorized representative of AIMCO, has made any attempt to service or modify the tool or accessory prior to its return to AIMCO under this Warranty.

The warranty provision with respect to each such product may be amended by AIMCO from time to time in its sole discretion. The liability of AIMCO hereunder shall be limited to replacing or repairing, at its option, any products which are returned freight prepaid to AIMCO and which AIMCO determines to be defective as described above or, at AIMCO's option, refunding the purchase price of such products.

AIMCO reserves the right to make periodic changes in construction or tool design at any time. AIMCO

specifically reserves the right to make these changes without incurring any obligation or incorporating such changes or updates in tools or parts previously distributed.

THE AIMCO WARRANTY IS IN LIEU OF ALL OTHER WARRANTIES, EXPRESSED OR IMPLIED, AND AIMCO EXPRESSLY DISCLAIMS ANY WARRANTY OF MERCHANTABILITY OR FITNESS FOR A PARTICULAR PURPOSE. THIS WARRANTY SETS FORTH THE SOLE AND EXCLUSIVE REMEDY IN CONTRACT, TORT, STRICT LIABILITY, OR OTHERWISE.

THIS WARRANTY IS THE ONLY WARRANTY MADE BY AIMCO WITH RESPECT TO THE GOODS DELIVERED HEREUNDER, AND MAY BE MODIFIED OR AMENDED ONLY BY A WRITTEN INSTRUMENT SIGNED BY A DULY AUTHORIZED OFFICER OF AIMCO.

LIMITATION OF LIABILITY

AIMCO'S LIABILITY PURSUANT TO WARRANTY OF THE PRODUCTS COVERED HEREUNDER IS LIMITED TO REFUND OF THE PURCHASE PRICE. IN NO EVENT SHALL AIMCO BE LIABLE FOR COSTS OF PROCUREMENT OF SUBSTITUTE GOODS BY THE BUYER. IN NO EVENT SHALL AIMCO BE LIABLE FOR ANY SPECIAL, CONSEQUENTIAL, INCIDENTAL OR OTHER DAMAGES (INCLUDING WITHOUT LIMITATION, LOSS OF PROFIT) WHETHER OR NOT AIMCO HAS BEEN ADVISED OF THE POSSIBILITY OF SUCH LOSS, HOWEVER CAUSED, WHETHER FOR BREACH OR REPUDIATION OF CONTRACT, BREACH OF WARRANTY, NEGLIGENCE OR OTHERWISE. THIS EXCLUSION ALSO INCLUDES ANY LIABILITY WHICH MAY ARISE OUT OF THIRD-PARTY CLAIMS AGAINST BUYER. THE ESSENTIAL PURPOSE OF THIS PROVISION IS TO LIMIT THE POTENTIAL LIABILITY OF AIMCO ARISING OUT OF THIS AGREEMENT AND/OR SALE.

Note: The AIMCO Warranty confers specific legal rights, however some states or jurisdictions may not allow certain exclusions or limitations within this warranty.

* All tools evaluated and deemed no problem found or tools to be sent back unrepaired are subject to an inspection fee (1/2-hour labor rate charge).

** All warranty periods addressed herein are determined using a standard shift, eight-hour workday.

05-25



AIMCO CORPORATE HEADQUARTERS
 10000 SE Pine Street
 Portland, Oregon 97216
 Phone: (503) 254-6600
 Toll Free: 1-800-852-1368

AIMCO CORPORATION DE MEXICO SA DE CV
 Ave. Cristobal Colon 14529
 Chihuahua, Chihuahua. 31125
 Mexico
 Phone: (01-614) 380-1010
 Fax: (01-614) 380-1019