



## Instruction Manual

# AM-45 / AM-65 Digital Management System for Screw Fastening



PO Box 16460, Portland OR 97292-0460

1-800-852-1368 • (503) 254-6600

[www.aimco-global.com](http://www.aimco-global.com)

## Table of Contents

Thank you for choosing our light and powerful electric screwdrivers and AM Series Digital Management System from screw fastening. To ensure the tool fully utilizes its maximum performance and extend its life, please read this manual before use.

General Safety Warnings .....	2
Read Before Use .....	4
Warranty Information .....	5
Product Information.....	7
Parts and Functions.....	9
Operation .....	15
Quick Reference .....	22
Troubleshooting .....	24
Assembly Drawing/Parts List .....	25-26

## GENERAL SAFETY WARNINGS



**WARNING:** Read all safety warnings and all instructions.



Failure to follow the warnings and instructions may result in electric shock, fire and/or serious injury.



Save all warnings and instructions for future reference.

### Work Area Safety

- Keep work area clean and well lit. Cluttered or dark areas invite accidents.
- Do not operate power tools in explosive atmospheres, such as in the presence of flammable liquids, gasses, or dust. Power tools create sparks, which may ignite the dust or fumes.
- Keep children and bystanders away while operating a power tool. Distractions can cause you to lose control.

### Electrical Safety

- Power tool plugs must match the outlet. Never modify the plug in any way. Unmodified plugs and matching outlets will reduce risk of electric shock.
- Avoid body contact with earthed or grounded surfaces, such as pipes, radiators, ranges, and refrigerators. There is an increased risk of electric shock if your body is earthed or grounded.
- Do not expose power tools to rain or wet conditions. Water

entering a power tool or its adaptor will increase the risk of electric shock.

- Do not abuse the cord. Never use the cord for carrying, pulling, or unplugging the power tool. Keep cord away from heat, oil, sharp edges, or moving parts. Damaged or entangled cords increase the risk of electric shock.
- When operating a power tool outdoors, use an extension cord suitable for outdoor use. This reduces the risk of electric shock.
- If operating a power tool in a damp location is unavoidable, use a residual current device (RCD) protected supply for its adaptor. Use of an RCD reduces the risk of electric shock.

### **Personal Safety**

- Stay alert, watch what you are doing, and use common sense when operating a power tool. Do not use a power tool while you are tired or under the influence of drugs, alcohol, or

medication. A moment of inattention while operating power tools may result in serious personal injury.

- Prevent unintentional starting. Ensure the switch is in the off position before connecting to a power source or battery pack, picking up, or carrying the tool.
- Carrying power tools with your finger on the switch, or energizing power tools that have the switch on invites accidents.
- Remove any adjusting key or wrench before turning the power tool on. A wrench or a key left attached to a rotating part of the power tool may result in personal injury.
- Do not overreach. Keep proper footing and balance at all times. This enables better control of the power tool in unexpected situations.
- Dress properly. Do not wear loose clothing or jewelry. Keep your hair, clothing, and gloves away from moving parts. Loose clothes, jewelry, or long hair can be caught in moving parts.

## Set-Up

- Use the AM Controller in an indoor, dry place that has no dust or iron grindings.
- Position the AM Controller on a stable surface to avoid falling caused by vibration.
- Keep the AM Controller away from high-voltage sources and noise-generating sources to avoid electromagnetic interference.
- Do not place objects on the top of the AM controller. Keep surroundings clear to allow heat dissipation.

## Caution During Operation

- Use the power supply only on an AC circuit with an overload relay.
- The plug of the power cord is attached with a ground pin. Ensure the ground pin is connected to a socket equipped with a ground circuit to avoid electric shock.
- Ensure the power cord is tightly plugged into the socket.
- Hold plug firmly when plugging in or unplugging cord that connects the AM Controller to the screwdriver. Do not pull on the cable; doing so could cause a short circuit.
- Ensure that the connecting cable to the screwdriver and the AM Controller is aligned properly with the guide slot before inserting (this may require force). Twist to fix the connection. This will reduce the occurrence of cord breakage due to drag.

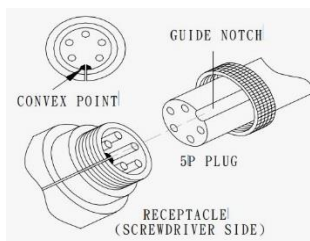

- Do not suddenly switch between forward and reverse when the electric screwdriver is in operation.
- We recommend that you use 80% or less of the rated maximum torque to avoid inaccurate clutch escape. Maximum torque may vary with the flexibility of the fastened object. If your application requires more than 80% of the rated maximum torque, using a screwdriver with higher torque is recommended.

## Safety Notice

- Stop using the product if there is any unusual noise or smell. Turn off the power immediately and contact your AIMCO service center.
- Keep the two-stage switch in the OFF position when the controller is not in use. If the controller will not be used for an extended period of time, disconnect the plug from the power-source socket.
- The AM Controller is designed only for use with Electra Series electric screwdriver. Do not use it with other tools.

## CAUTION

Output terminal 5P-5P Needle No. 1 is “-” potential, and No. 4 is “+” potential.

## **NEW TOOL AND ACCESSORY WARRANTY**

Any new tool or accessory branded with the AIMCO, Uryu, AcraDyne or Eagle Industries name, and purchased from AIMCO, or through one of its authorized distributors or agents, is warranted to the original buyer against defects in materials and workmanship for a period of one (1) year\* from date of delivery. Under the terms of this warranty, AIMCO will repair or replace any product or accessory warranted hereunder and returned freight prepaid proving to AIMCO's satisfaction to be defective as a result of workmanship or materials. In order to qualify for this warranty, written notice to AIMCO must be given immediately upon discovery of such defect, at which time AIMCO will issue an authorization to return the tool. The defective item must be promptly returned to an authorized AIMCO service center with all freight charges prepaid.

### **REPAIRED TOOL WARRANTY**

---

Once a tool is beyond the new product warranty period as detailed above, AIMCO repairs are subject to the following warranty periods: pneumatic tools: 90 days\*; electric tools and Acra-Feed: 90 days; battery tools: 30 days\*; DC Electric tools: 90 days\*

### **EXCLUSION FROM WARRANTY**

---

This warranty is valid only on products purchased from AIMCO, or through its authorized distributors or agents. AIMCO shall have no obligation pursuant to the AIMCO Warranty with respect to any tools or accessories which in AIMCO's sole judgment have been altered, damaged, misused, abused, badly worn, lost or improperly maintained. This Warranty is null and void if the customer, or any other person other than an authorized representative of AIMCO, has made any attempt to service or modify the tool or accessory prior to its return to AIMCO under this Warranty.

The warranty provision with respect to each such product may be amended by AIMCO from time to time in its sole discretion. The liability of AIMCO hereunder shall be limited to replacing or repairing, at its option, any products which are returned freight prepaid to AIMCO and which AIMCO determines to be defective as described above or, at AIMCO's option, refunding the purchase price of such products.

AIMCO reserves the right to make periodic changes in construction or tool design at any time. AIMCO specifically reserves the right to make these changes without incurring any obligation or incorporating such changes or updates in tools or parts previously distributed.

THE AIMCO WARRANTY IS IN LIEU OF ALL OTHER WARRANTIES, EXPRESSED OR IMPLIED, AND AIMCO EXPRESSLY DISCLAIMS ANY WARRANTY OF MERCHANTABILITY OR FITNESS FOR A PARTICULAR PURPOSE. THIS WARRANTY SETS FORTH THE SOLE AND EXCLUSIVE REMEDY IN CONTRACT, TORT, STRICT LIABILITY, OR OTHERWISE.

THIS WARRANTY IS THE ONLY WARRANTY MADE BY AIMCO WITH RESPECT TO THE GOODS DELIVERED HEREUNDER, AND MAY BE MODIFIED OR AMENDED ONLY BY A WRITTEN INSTRUMENT SIGNED BY A DULY AUTHORIZED OFFICER OF AIMCO.

### **LIMITATION OF LIABILITY**

---

AIMCO'S LIABILITY PURSUANT TO WARRANTY OF THE PRODUCTS COVERED HEREUNDER IS LIMITED TO REFUND OF THE PURCHASE PRICE. IN NO EVENT SHALL AIMCO BE LIABLE FOR COSTS OF PROCUREMENT OF SUBSTITUTE GOODS BY THE BUYER. IN NO EVENT SHALL AIMCO BE LIABLE FOR ANY SPECIAL, CONSEQUENTIAL, INCIDENTAL OR OTHER DAMAGES (INCLUDING WITHOUT LIMITATION, LOSS OF PROFIT) WHETHER OR NOT AIMCO HAS BEEN ADVISED OF THE POSSIBILITY OF SUCH LOSS, HOWEVER CAUSED, WHETHER FOR BREACH OR REPUDIATION OF CONTRACT, BREACH OF WARRANTY, NEGLIGENCE OR OTHERWISE. THIS EXCLUSION ALSO INCLUDES ANY LIABILITY WHICH MAY ARISE OUT OF THIRD PARTY CLAIMS AGAINST BUYER. THE ESSENTIAL PURPOSE OF THIS PROVISION IS TO LIMIT THE POTENTIAL LIABILITY OF AIMCO ARISING OUT OF THIS AGREEMENT AND/OR SALE.

Note: The AIMCO Warranty confers specific legal rights, however some states or jurisdictions may not allow certain exclusions or limitations within this warranty.

\* All warranty periods addressed herein are determined using a standard shift, eight-hour work day.

## AM Series Controller Features

- Prevents incomplete fastening, stripping, and idling
- Prevents the possibility of missing screws during the fastening operation
- LCD monitor shows clear counting information
- Green color on the monitor indicates OK fastening and Red color indicates NG fastening
- AM Controllers can connect to peripheral equipment with standard input/output signals



## Specifications

Model	AM-45	AM-65
Counting range of accumulative fastening for work pieces	1 – 60,000	
Range of Set Number of Fastening for a single work piece	1 – 99	
Setting Range of Number of Sample Fastening Time	1 – 99	
Range of Number of Memory/Calling-out of setting	10 / 10 set	
Range of Sampling Fastening Time	0.01 – 9.99 seconds	
Setting Range of Fastening Time Error	± 1 – 99 %	
Judgment	OK sound and green LED light on NG sound and red LED light on	
Signal Output Mode	Dry contact (no voltage contact signal)	
Input Voltage (VAC)	100 – 240V, 50/60Hz	
VDC Output Voltage (VDC)	25 – 35V	20 – 30V
Output Voltage Setting	Stepless control	
Output Pin	5P	
Internal signal output	Switch signal, shut-off signal, work piece complete signal, OK fastening signal, NG fastening signal	
External signal input	Switch signal	
No. of screwdrivers per controller	1 pc	
Power (W)	70W	75W
Applicable Model	AE-2020/ESD AE-4020/ESD AE-4520/ESD	AE-7010/PS AE-8010/PS
Dimension	176 x 84 x 61 mm (6.9 x 3.3 x 2.4 in)	
Weight	450 g (1.0 lb)	
AC cable length (m)	1.8 M (6 ft)	
Safety Approval	CB, CE, UL (CUL), CCC, ROHS, REACH	
Accessories	Small screwdriver, 2P/4P terminal block, AC cable	



**Speed Setting**

Change the speed setting by turning the speed-setting screw on the side of the power supply with the small screwdriver (standard accessory).

- Turn clockwise ↻ 0→10 to increase the speed.
- Turn counter-clockwise ↻ 10→0 to lower the speed.

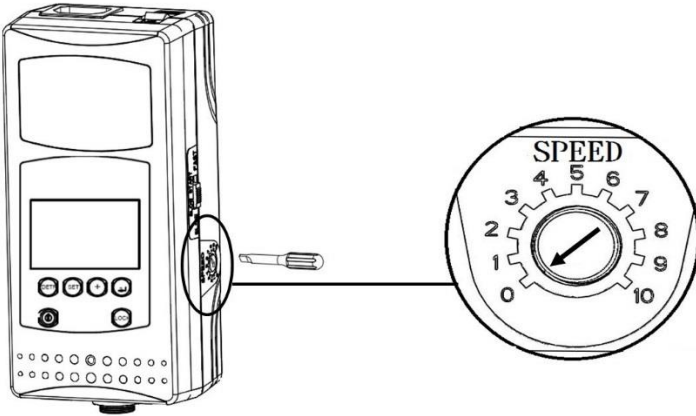

**AM Controller Panel Keys**

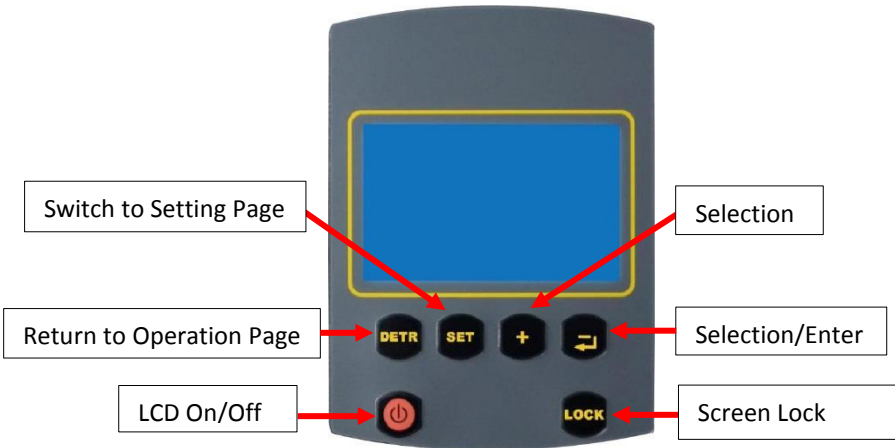

**Power Setting and AC Input Socket (C13 Specification)**

The input voltage of the power supply is ranged between 100–240VAC, 50/60 Hz. Use the correct voltage to avoid any damage to the power supply.

- Connect one side of the cable to the AC power socket and the other side to the electric socket (C13 specification) of the AM Controller.
- Change the two-stage switch on the top of the AM Controller by hand.
  - On mode: the power supply will be switched on.
  - Off mode: the power supply will be switched off.

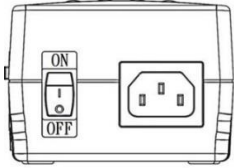
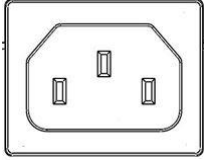
Two-Stage Switch	Top of the AM Controller	AC input socket (C13 specification)
		

**Indicator Light**

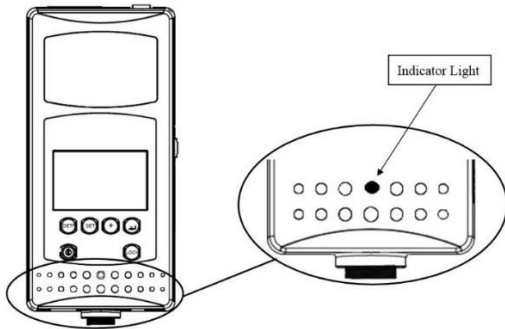

Light Color	Description
Green Light	After switch on, the light flashes orange three times, then turns to green
No Light	No DC voltage output
Flashing Green	Short circuit protection
	Over power protection
Red Light	Brakes
Flashing Red	Heating protection (temperature set at 167°–185° F (75°–85° C))

## OUTPUT-A: Signal Output Terminal Block

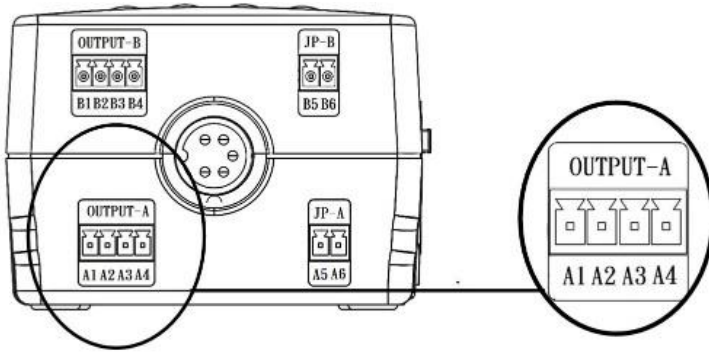

- A3 & A4: “Switch on” signal output. When the electric screwdriver is switched on, A3 and A4 will export DC voltage.
- A1 & A2: “Shut-off” signal output. When the electric screwdriver has reached its set torque and stopped, DC voltage will be exported.

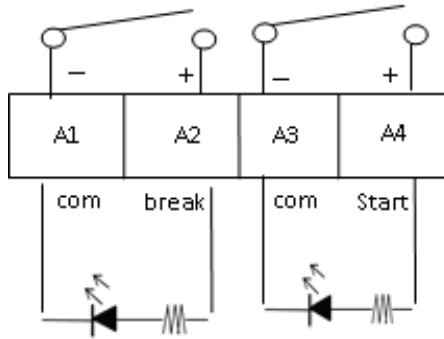

- “Shut-off” and “switch on” signal output voltage will be changed with the speed button: AM-45 (DC 25–35V), AM-65 (DC 20–30V)
- Brake signal output voltage and corresponded screwing manager models: AM-45 (DC 35V), AM-65 (DC 30V).

## JP-A Terminal Block for External Controller

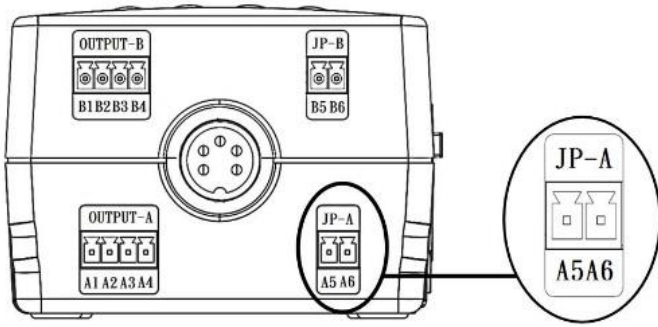

- Connect between AM-45/AM-65 controller and the automation equipment via PCB: Connect A1 to K5, and connect H2 to H1. You can use the external controller to control the AM Controller. This is for automation ONLY.

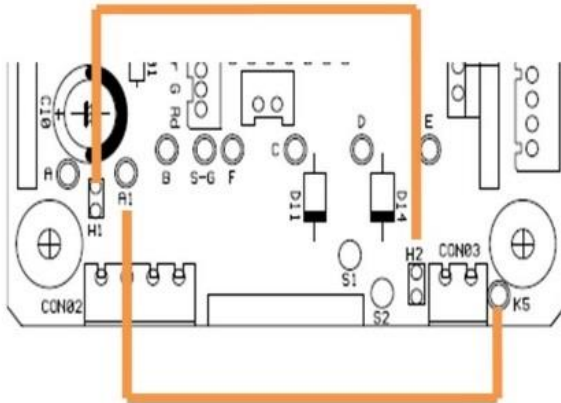

## OUTPUT-B: Signal Output Terminal Block

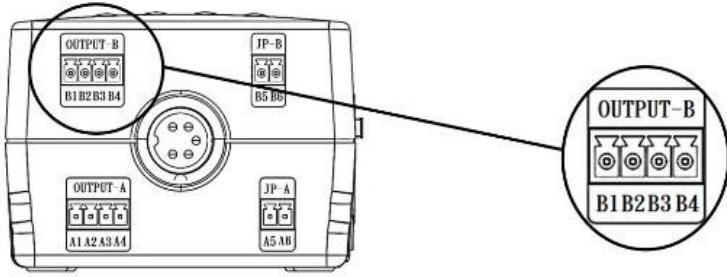

OUTPUT-B Pin and corresponding output mode:

- A single unit is fastened completely (B1 & B4 are conductive)
- OK screw fastening each time (B3 & B4 are conductive)
- NG screw fastening each time (B2 & B4 are conductive).
- No voltage contact signal (dry contact).
- When WORK function is connected to the production line, I/P (B5, B6) will be connected to the switch

## JP-B: Signal Output Terminal Block for External Control ONLY

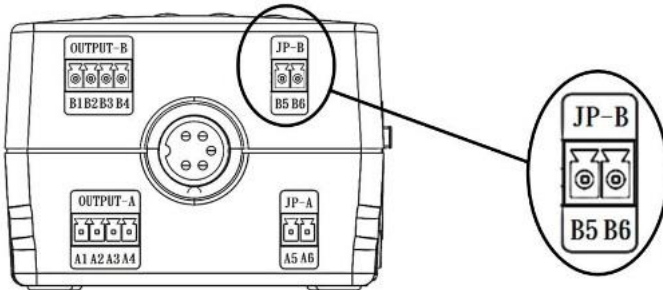

JP-B Pin and corresponding output mode:

- Under the mode WORK I/P, B5 and B6 should be conductive in order to operate. Both the AM Controller and the external controller can be monitored by the operator at the same time. The signal of the sensor used in the production line can be delivered to the AM Controller. When B5 and B6 are connected, the AM Controller can work independently as a monitor.
- A5, A6: Start signal for automation ONLY. Use the external controller to control the conduction and non-conduction between the screwing manager and the electric screwdriver.

### Screw Holes for Assembly of the AM Controller and Balancer

Screw holes at the bottom of the AM Controller allow it to be mounted on an SB-series balancer (optional accessory) and a fixed board. Please follow the instruction below:

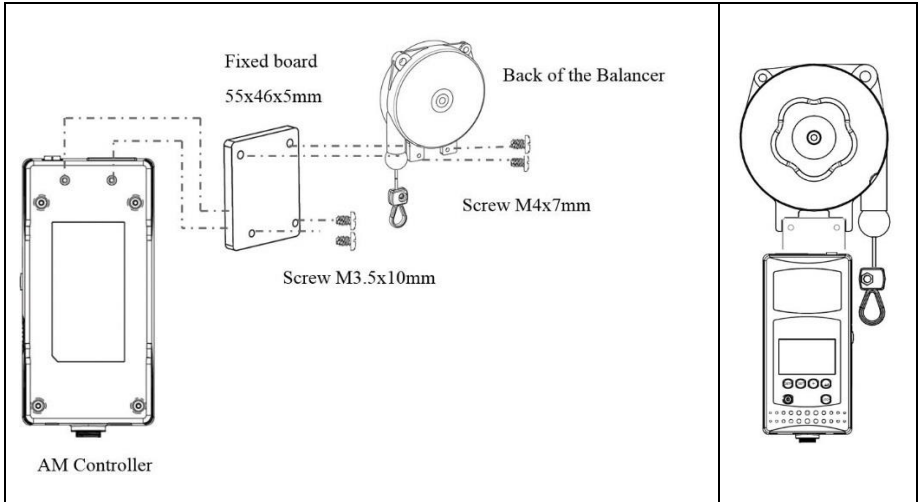

## Operation of AM Controller

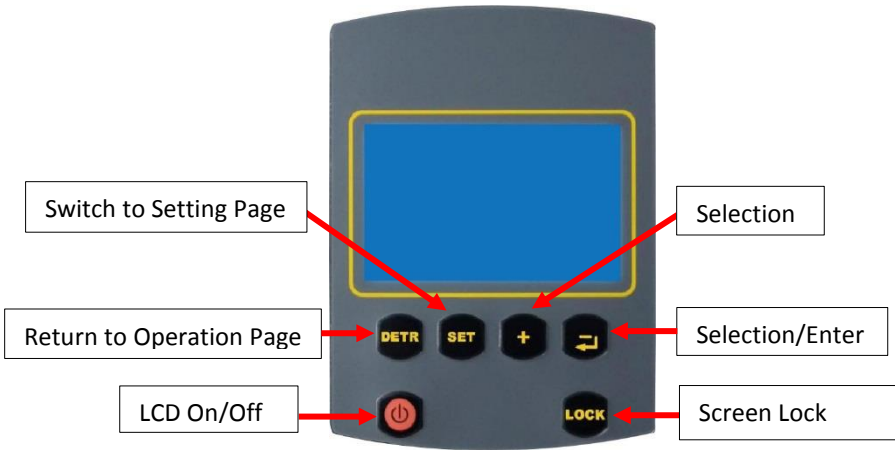

**Step 1:** Connect the screwdriver to the AM controller with the 5P cable.

**Step 2:** Plug the power cord into the electric socket (110V / 220V).

**Step 3:** Press the On/Off key .

**Step 4:** Screen (1) will display after 3 seconds.

(Skip to Step.7 if you don't need to erase the memory or change the language.)

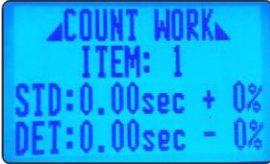
<b>Screen 1: Number of OK / NG Tightenings</b>	
	<p>Screen 1 shows the numbers of OK or NG screw tightening for each unit during the operation.</p> <p>Press  to switch to screen (2)</p>
<b>Screen 2: Preset Fastening Time</b>	
	<p>Screen 2 shows the preset standard time of each screw fastening task, the tolerance, and the actual screw fastening time. "ITEM 1" indicates the item you use during the operation. Press  to return to screen (1)</p>

**Step 5:** Press **LOCK** for 3-4 seconds and screen (3) “MEMO CLEAR” will display.

<b>Screen 3: Memo Clear</b>	
	Screen 3 lets you clear all setting records. Press <b>+</b> key to delete; Press <b>↩</b> key to return to screen (1)

**Step 6:** Screen (4) press **+** **SET** **DETR** at the same time for 3-4 seconds. The language menu will display.

<b>Screen 4: Language Selection</b>	
	AM controller language selection: Press <b>+</b> to choose ENGLISH or CHINESE. Press <b>↩</b> key to confirm and return to screen (1).

**Setting Mode: Entering the Parameters of your Project**

Once you've entered Setting Mode, you can set sampling time, data memory, and save or recall your preferred item.

**Step 7:** From screen (1), press **SET** to enter setting mode on screen (5).

**Step 8:** Enter password.

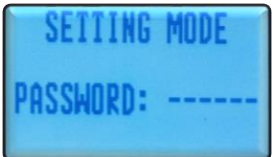
<b>Screen 5: Enter Password to Access Setting Mode</b>	
	Enter password <b>+</b> <b>+</b> <b>↩</b> <b>↩</b> <b>SET</b> <b>DETR</b> to continue to screen (6). If you enter the wrong password, screen (1) will display.

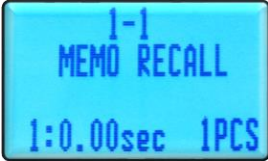

**Step 9:** The Memo Recall screen lets you select the item you want to recall. If you do not need to recall any item, press **SET** from this screen, which will take you to screen (7).

<b>Screen 6: Memo Recall</b>	
	Choose the set memo (max. 10 items): Press <b>+</b> key to choose the item you want to recall. Press <b>SET</b> key to switch to screen (7). Press <b>↩</b> key to return to screen (2), which shows count work for the item you just selected.

**Step 10:** Every time you want to set the item or values, you must clear all previous counting records to avoid repeated counting in the new item. Once you have cleared the counting records, simply press **SET** from screen (7) to switch to screen (8).

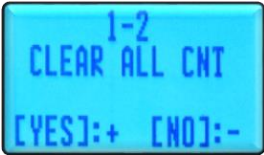
<b>Screen 7: Clear Previous Counts</b>	
	Clear all counting records of the chosen item (OK, NG, PASS) and reset: Press <b>+</b> key to delete. This will return you to screen (6) Press <b>↩</b> key to keep records and return to screen (6). Selecting either of these two options will return you to screen (6). In order to proceed to the next step, from screen (6) press <b>SET</b> to return to screen (7), but instead of making a “yes” or “no” selection, press <b>SET</b> to proceed to screen (8)

**Step 11:** The Memo Set screen allows you to search for the item number you want to save.

<b>Screen 8: Memo Set</b>	
	Memo setting (max. 10 items): Press <b>+</b> key to select memo from 1 to 10. Choose the preferred memo and press <b>SET</b> key to confirm and switch to the next screen.

**Step 12:** Screen (9) allows you to set the number of pieces (samples) for which you will record a fastening time.

Screen 9: Set Number of Samples	
	<p>Press  key to increase the quantity (max 99 pieces).</p> <p>Press  key to decrease the quantity.</p> <p>Press  key to confirm and switch to the next screen.</p>

**Step 13:** Start fastening. Screen (10) shows the identifying number of the sample, the total number of samples in the project, and the actual fastening time for each sample screw fastened. You must confirm whether the value is valid.

Screen 10: Validate Fastening Times	
	<p>Press  key to confirm that the fastening time is valid; Press  key if the fastening time is invalid. This will automatically take you to the next sample. Continue fastening until all the preset sample screws you entered on screen (9) are fastened. When you finish recording all the sample fastening times, it will switch to the next screen automatically.</p>

**Step 14:** Set the values according to your preference on screens (11) – (17).

Screen 11: Set Upper-Limit Percentage of Sample Fastening Time	
	<p>Max. upper-limit percentage is 99%.</p> <p>Press  to increase; Press  to decrease.</p> <p>Press  to confirm and switch to the next screen.</p>



Screen 12: Set Lower-Limit Percentage of Sample Fastening Time	
	<p>Max. lower-limit percentage is 99%.</p> <p>Press  to increase; Press  to decrease.</p> <p>Press  to confirm and switch to the next screen.</p>

Screen 13: Set Number of Screws to Fasten for Each Unit	
	<p>Max. 99 pieces</p> <p>Press  to increase; Press  to decrease.</p> <p>Press  to confirm and switch to the next screen.</p>
Screen 14: Set Counting Logistics of Completed Fastened Unit (Increase/Decrease)	
	<p>Press  to add up numbers of completed unit.</p> <p>Press  to subtract numbers of completed unit.</p> <p>Press  to confirm and switch to the next screen.</p>
Screen 15: Set Fastening Time	
	<p>Preset the fastening time for each task from 0.1 – 99.9 seconds. The alarm will go off when the fastening task is not completed within the preset time.</p> <p>Press  to increase; Press  to decrease.</p> <p>Press  to confirm and switch to the next screen.</p>
Screen 16: Set Number of Completed Sets	
	<p>If you chose “+” on screen (14), the alarm will sound when the total number of completed sets reaches the preset amount. Max. 60,000 sets.</p> <p>Press  key to increase; Press  key to decrease.</p> <p>Press  key to confirm and switch to the next screen.</p>
	<p>If you chose “-” on screen (14), the alarm will sound when the set value is “0.” Max. 60,000 sets.</p> <p>Press  to increase; Press  to decrease.</p> <p>Press  to confirm and switch to the next screen.</p>

### Screen 17: Adjust Average Sample Fastening Time



Max. 9.99 seconds.

Press  to increase; Press  to decrease.

Press  to confirm and switch to the next screen.

**Step 15:** Screen (18) shows the accumulative number of incomplete fastening tasks passed when there is defective set.

### Screen 18: Number of Incomplete Fastening Tasks

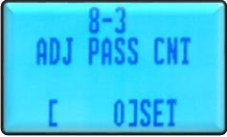



Max. 60,000 sets

Press  to confirm and switch to the next screen.



**Step 16:** Screen (19) lets you save the values of the current Memo Set.

### Screen 19: Save Set Values



Press  to save; Press  to cancel and return to screen (6)

**Step 17:** If you want to set the next item, press  on screen (6) to select the item and repeat steps 7–16.

**Step 18:** Once you are finished, press  to return to screen (1). Press  to see count work screen (2).

**Step 19:** Using WORK I/P function:

#### 19-1: Connect to the production line

You can monitor your production line by connecting B5 & B6 of the JP-B socket to the external controller. Once B5 & B6 are connected to the workstation, the positioning sensor signal will be transported to the AM Controller, and it will become a monitor. The alarm will sound if you pass the incomplete fastened unit (the torque value, the fastening time, and numbers of screws must reach the preset values). If the unit itself is defective, you can pass it and press  to silence the alarm and return

to operation mode. Every unit you pass will be recorded in screen (18) for your reference.

#### 19-2: Independent Work Station

The AM Controller can be used as an independent workstation by connecting B5 and B6 to each other.

**Step 20:** You can now start using the screwdriver after completing all the settings for your project.



### Turn On/Off the AM controller

**Turn on:** Turn the power switch to ON, then press LCD power key . The AM Controller will turn on. (The record will be saved after switching off and restart.)





**Turn off:** Press LCD power key  for 2–3 seconds. the AM Controller will turn off. Turn the power switch to OFF.

### LOCK key function



(1): Press  to lock the AM Controller. The power supply of the AM Controller still provides electricity. This prevents any record alteration due to improper use of the electric screwdriver during standby time.

(2) As outlined in Operation Steps 5 & 6, pressing  for 3–4 seconds will take you directly to the “MEMO CLEAR” (screen 3). Press  to delete; Press  to save. Either of these options will return you to screen (1)

### Language Selection



From screen (1), press    for 3–4 seconds until the Language screen displays. Press  to choose either ENGLISH or CHINESE. Press  to confirm and switch to screen (1).

### Volume Adjustment



Press  or  on screen (1) or (2). Screen (20) will display and you can adjust the volume.

#### Screen 20: Volume Adjustment



Press  to increase the volume; Press  to decrease the volume. The screen will return to screen (1) when the standby time is over 3 seconds.

## Alarms

- One beep: OK fastening of a single screw
- One Long beep:
  - Numbers of fastened screws of a unit do not reach the set amount. Press  to silence beep
  - The fastening task is not completed when the preset CYCLE TIME is reached. Press  to silence beep
- Three beeps (quick and short): Thread damage or abnormal screw fastening of a single screw
- Four beeps: Numbers of fastened units reaches the set amount

## LCD lights

- Blue light: Operation screen
- Green light: OK screw fastening
- Red light: NG screw fastening
- White light: Setting screen
- Yellow light: Screen lock
- Purple light for (1-2 seconds) and then green light: Numbers of completed units reaches the set amount
- Purple light: The task is not completed within the preset CYCLE TIME

## Screen Errors

If you notice any screen error or scrambled code, you can restart the AM Controller. If you still notice the same problem after restarting the machine, please contact your local sales agent immediately.

## **Troubleshooting**

If the screwdriver does not work properly, follow the checklist below to examine your screwdriver. If none of the following points applies to the problem you encounter, do not open the unit. Contact your local sales agent immediately for further guidance.

<b>Problem</b>	<b>Solution</b>
Screwdriver does not operate	Verify that power plug is correctly and tightly plugged into the designated power source.
	Verify that there is designated voltage between 5P-5P terminal block needle no. 1 (“-“ potential), no. 4 (“+” potential).
	Check whether the connection wire plug of 5P-5P is broken. If it is broken, replace it with a new connection wire or new plug. (This problem usually occurs at the plug that connects to the screwdriver.)
Screwdriver keeps rotating (except reverse rotating) or screwdriver does not shut off automatically when the preset torque is reached and clutch is released	The AM Controller is designed with an electric braking system. If you experience this problem, contact an authorized service center.
Screwdriver does not stop automatically when the clutch shuts off at preset torque	The AM Controller is designed with an electric braking system. If you experience this problem, contact an authorized service center.



# Assembly Drawing

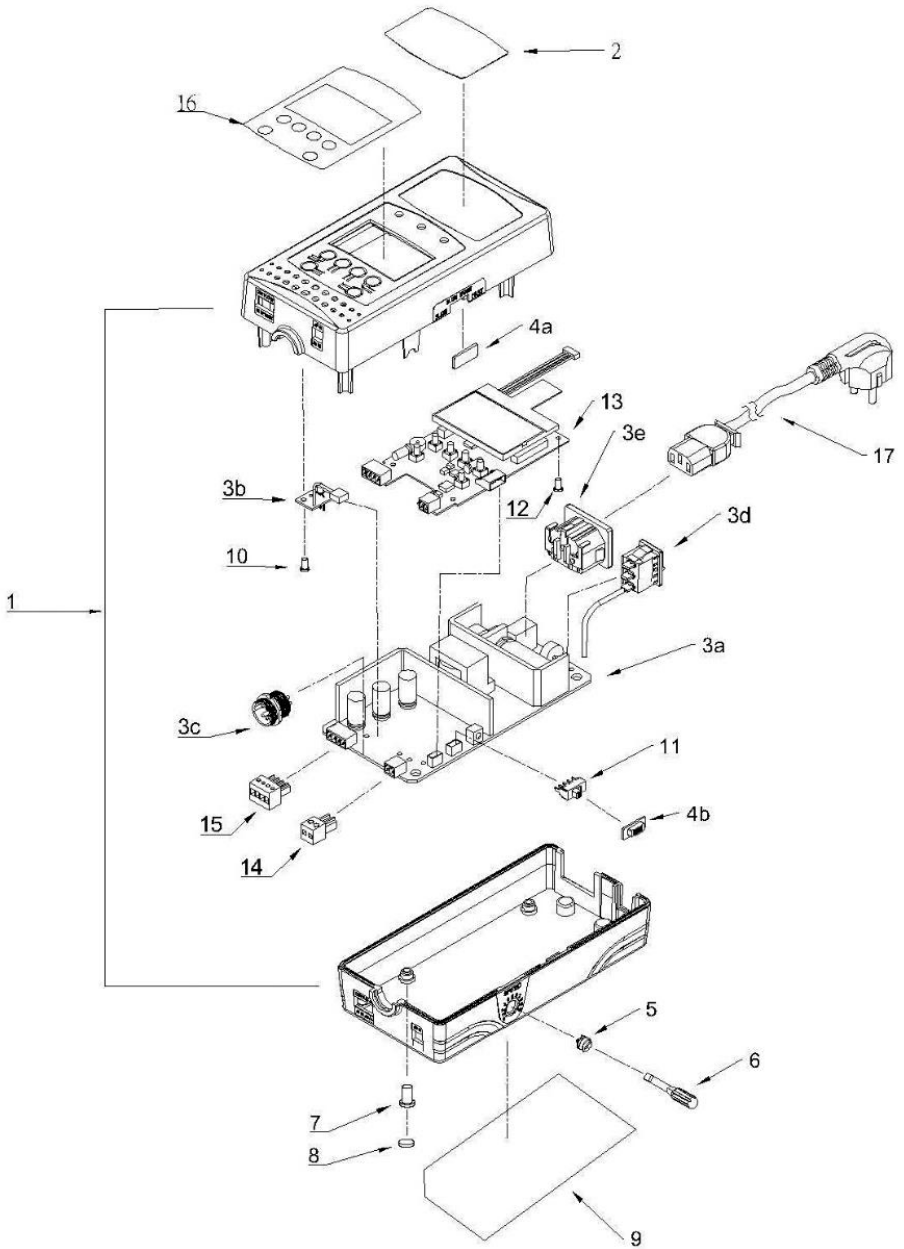

## Parts List

Index #	Part #	Description	Qty.
1	6Z2073	Plastic Housing (Upper Cover)	1
	6Z2074	Plastic Housing (Lower Cover)	1
2	Differs	Model Label	1
<b>Parts for AM-45</b>			
3	2A2937	PCB Sub Ass'y Set	1
3a	2A2937-MP	PCB Sub Ass'y Set	1
3b	2A2917-LP	LED PCB Sub Ass'y Set	1
3c	6G1001	Plastic Plug (5P)	1
3d	2S2038-1	On/Off Switch	1
3e	2G4010	AC Inlet	1
<b>Parts for AM-65</b>			
3	2A2938	PCB Sub Ass'y Set	1
3a	2A2938-MP	PCB Sub Ass'y Set	1
3b	2A2917-LP	LED PCB Sub Ass'y Set	1
3c	6G1001	Plastic Plug (5P)	1
3d	2S2038-1	On/Off Switch	1
3e	2G4010	AC Inlet	1
<b>Common Parts</b>			
4a	6V1064	Screen (for no-start)	1
4b	6V1063	Push Button (for soft start)	1
5	6R3016	Adjustment Button	1
6	6R3017	Plastic Screwdriver	1
7	8T2090	Screw M3 x L16	4
8	6B3020	Foot (6.5 x 3.0)	4
9	Differs	Safety Label	1
10	8T2663	Screw M2.5 x L6	1
11	2A7091	Switch Sub Ass'y Set	1
12	8T2623	Screw M5 x L5	4
13	2A4012	LED Panel	1
14	2T6011	Terminal Block 2P	1
15	2T6012	Terminal Block 4P	1
16	7L1450	Panel Label	1
17	2W1024	AC Cable (USA Type)	1





[WWW.AIMCO-GLOBAL.COM](http://WWW.AIMCO-GLOBAL.COM)

#### **CORPORATE HEADQUARTERS**

10000 SE Pine Street  
Portland, Oregon 97216  
Phone: (503) 254-6600  
Toll Free: 1-800-852-1368

---

#### **AIMCO CORPORATION DE MEXICO SA DE CV**

Ave. Cristobal Colon 14529  
Chihuahua, Chihuahua. 31125  
Mexico  
Phone: (01-614) 380-1010  
Fax: (01-614) 380-1019

#### **AIMCO EUROPE**

Dibao Plaza Avenida Río Gallo, 431  
19174 Galápagos - Guadalajara  
Spain  
Phone: + 34 673 34 99 25

#### **AIMCO CHINA**

Room 607, No. 3998 Hongxin Rd  
Minhang District, Shanghai  
China  
Phone: 0086-21-34319246  
Fax: 0086-21-34319245

#### **AIMCO SOUTH KOREA**

B-1213, 167, Songpa-Daero  
Songpa-Gu, Seoul 05800  
South Korea  
Phone: 0082-2-2054-8930  
Cell: 0082-10-9804-8905

#### **AIMCO SOUTH AMERICA**

Calle Congreve No 800. Escobar  
El Aromo. L207  
Provincia de Buenos Aires  
Argentina  
CP: 1625  
Phone: +54 9 11 3341 0543

LIT-MAN786 Rev. 08-02-18  
Printed in USA ©2018 AIMCO