



AIMCO

**Fastening Counter
UTM – 1500**

Instruction Manual

(Software Version 1.06)

PO Box 16460, Portland OR 97292-0460 • 800-852-1368 • Fax 800-582-9015

www.aimco-global.com

Table of Contents

Safety Precautions	3
(1) Shut-off Tool (TM).....	7
Exterior Features.....	11
(1) Front Side.....	11
(2) Back Side.....	13
Functions.....	14
Settings.....	15
S E T U P	16
AUTOMATIC SET UP (automatic setting)	25
TIMER.....	26
TERMINAL ALLOCATION (Terminal Block Input/Output Alternatives)	28
(1) Choice among terminal block input alternatives.....	28
(1) Choice among terminal block output alternatives.....	29
W I R I N G D I A G N O S I S (Terminal Block Wiring Diagnosis)	30
(1) Input Wiring Diagnosis	30
(2) Output Wiring Diagnosis	30
M E M O R Y	31
B A U D R A T E (transmission speed)	31
T o o l m a n a g e m e n t (tool management)	32
(1) T O O L	32
(2) O U T S E T	32
(3) C U M U L A T I V E C O U N T	34
Pressure Value Setting	35
(1) In the case of Shut-off Tool (TM).....	35
(2) In the case of TM Type Tool	35
(3) In the case of Standard Tool.....	35

Safety Precautions

You should first read this manual thoroughly and become familiar with this System and safety precautions before installing, operating, servicing and inspecting it.

Take note that two different signs; “DANGER” and “CAUTION”, are used in this Manual according to the degree of seriousness and urgency.



: A fatality and/or heavy personal injury is highly possible by misoperation. Urgent warning is essential in the event of an accident.



: A dangerous situation accompanying mid-slight personal injury and/or property damage is possible by misoperation.



signs also warn the risk of serious consequences depending on the situation. So, always follow the instructions given in this Manual.

◆ Installation & Surroundings



CAUTION

- Always attach to a metal or other incombustible component to prevent a fire.
- Keep away from combustibles to prevent a fire.
- Avoid foreign matter intrusion to prevent a fire.
- Set up Controller on a site that can bear its weight to avoid personal injury from accidental falling.
- Keep your workplace well lighted and clean to avoid personal injury.
- Never wear loose-fitting clothes or dangling jewelry when using this System, and always wear the right clothes suitable for your job. In addition, be careful not to get your hair caught in tools, and if you wear your hair long, always tie with a rubber ribbon or the like and wear a protective helmet to prevent personal injury.
- Securely install and fix this System to avoid personal injury in case of an emergency like an earthquake.

◆Wiring



Danger

- Be sure to turn OFF the mains prior to wiring to avoid an electric shock or a fire.
- Make sure that cords and outlets are properly grounded to avoid an electric shock or a fire.
- Carry out wiring after you installed Controller to avoid an electric shock or a fire.
- Wiring must be carried out by an expert electrician to avoid an electric shock or a fire.
- Always use Y-shape or round crimp terminals when wiring Terminal Block to avoid an electric shock or a fire.



Caution

- Be sure that Controller rated voltage agrees with AC power source to avoid personal injury and a possible fire.
- Wires must be routed and fixed properly and securely to avoid personal injury and a fire.

◆Handling/Operation



Danger

- Assurance of work-site safety by operators themselves prior to power switching operation is essential to prevent personal injury.
- Never touch switching devices with moistened hands to avoid an electric shock.
- Avoid touching the terminals of current-carrying Controller even during Tool is under non-operating conditions to avoid an electric shock.
- Avoid damage, mechanical stress, load to cords and never tuck them in forcibly to avoid an electric shock.
- Be sure to turn OFF the mains after each use.



Caution

- Make settings within the confines of the prescribed operating range to avoid personal injury and burns.
- Perform operations in safe surroundings while keeping proper footing. Avoid poor postures to prevent danger.
- Perform operations with extra care. Operations in a careless and inappropriate manner and/or long-duration operation is prohibited to avoid personal injury or work-related diseases.

◆ Maintenance/Serviceing



Danger

- Turn off and unplug the mains prior to inspection/replacement to avoid an electric shock.
- Maintenance/servicing works only by an expert is allowed. Be sure to take off metal articles (wrist-watch or ring) prior to operation. Inspect cords periodically for damage, and have an expert make repairs or exchange if signs of wear is noticed. Always use insulating tools at the time of servicing to avoid an electric shock and personal injury.
- Always order us or our designated agent when overhauling becomes necessary to avoid an electric shock, personal injury and fire.

◆ Disposal



Caution

- Dispose of your System as an industrial waste.

◆ Others



Danger

- Never add modifications to your System to avoid an electric shock, injury or fire.
- Stop your System right away and cut off the power whenever something unusual occurs.

General Precautions

- Keep persons irrelevant to System operation away from work-sites.

Specifications

Items	Particulars
Power Source	AC100~240V±10% adaptable
Power Consumption	40VA
Outer Dimension	210 (W) x 100 (H) x 200 (D) mm
Weight	Connector Type : about 2.03 kg Pressure Sensor On-board Type: about 2.05 kg
Display	2-digit digital display Indication : Remaining count number (“WORK No.” at the time of setting value inputting)
	LCD 20 characters×4 lines Indication : Setting value, pressure value, alarm message, judgment, fastening time, pulse number
Lamp	Fastening number judgment: OK (green)/NOK (red), Size 14x14
Buzzer	High-tone electronic buzzer. Buzzer currently used in UTM-1100 is interchangeable.
Setting Method	Front Panel Key Switch
	PC (use our original software)
Terminal Block	Input: 6 points, Output: 5 points 20P detachable type (Sato Parts ML-100-AS-20)
Pressure Signal Input	Connection with the pressure sensor incorporated in Tool via the connector at the back allows power supply and analog signal input.
Analog Output	Plug Size: JISC6560 (small, single-head plug $\phi 3.5 \times 15$)
Major Functions	Fastening number control Fastening time control Pulse number control ※1 Various judgments
Others	Two types of controllers are available, one is pressure sensor incorporated type and the other is connector incorporated type as follows: Pressure Sensor Incorporated Type : UTM-1500 (PS) Connector Incorporated Type : UTM-1500 (CN)

※1 : For pulse detection, prepare a 30cm-long or shorter TM Signal hose to connect Tool and Pressure Sensor.

There are times when pulse detection is impossible in the case that a less pneumatic pressure fluctuation type tool (like a small tool) is in use and/or depending on the work conditions.

Tool Connection

- Make the length of TM Signal air hose between Tool and Pressure Sensor (external pressure sensor/main body incorporated sensor) or Air-electric Relay as short as possible. A lengthy air hose may sometimes cause a delay in detecting pneumatic pressure fluctuations or hinder correct detection. (Shorter than 5m is recommended)
- In the case of fastening pulse number detection, the length of TM Signal air hose between Tool and Pressure Sensor must be maintained shorter than 30cm. TM Signal air hose of longer than 30cm will interfere with air pulsation taking during pulsing.
- When using TM Tool or Standard Tool, place Solenoid Valve at an adequate point so as the length of the air hose up to Tool will be maintained as short as possible. When the air hose between Solenoid Valve and Tool is unnecessary lengthy, Tool stop timing will be delayed due to residual pressure in the hose even though the valve reacted normally.

(1) Shut-off Tool (TM)

①When using UTM-1500(CN) and External Pressure Sensor Assembly

- Place External Pressure Sensor Assembly as close as possible to Tool.

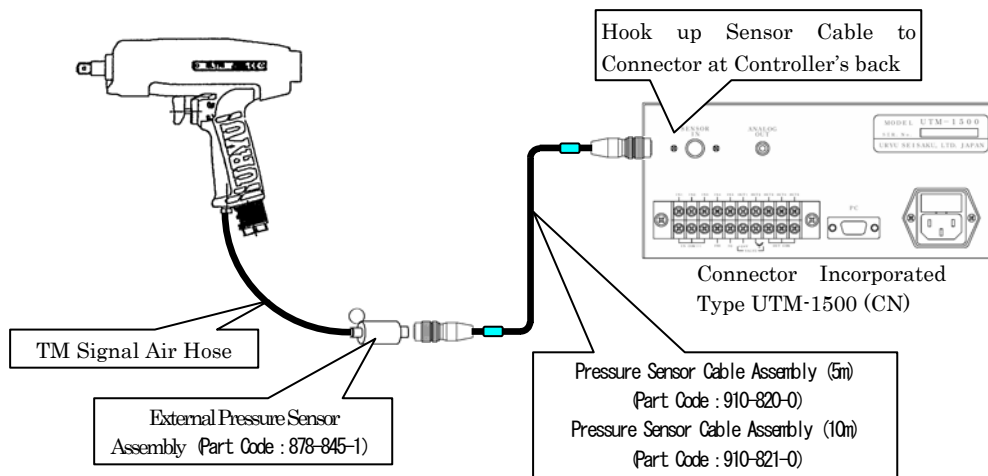

②When using UTM-1500 (RA-CN)

- Same wiring as in the case of without a rack (①).

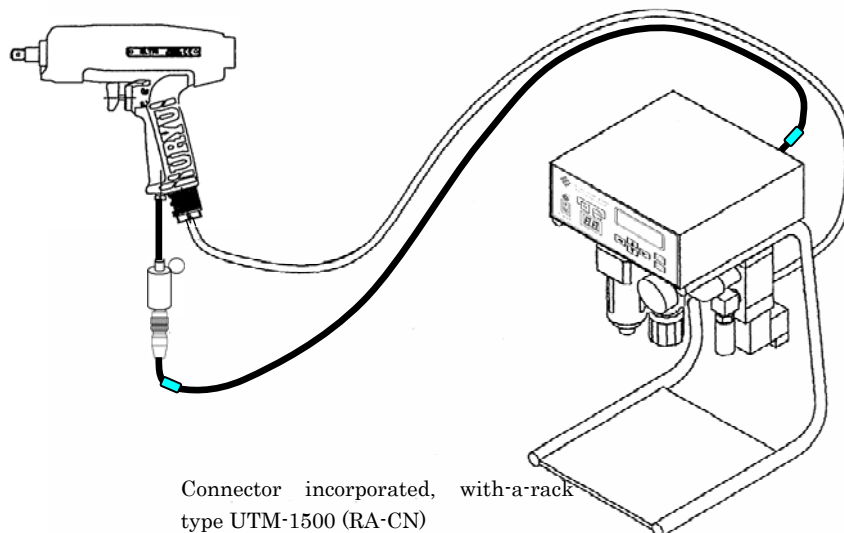

③When using UTM-1500 (PS)

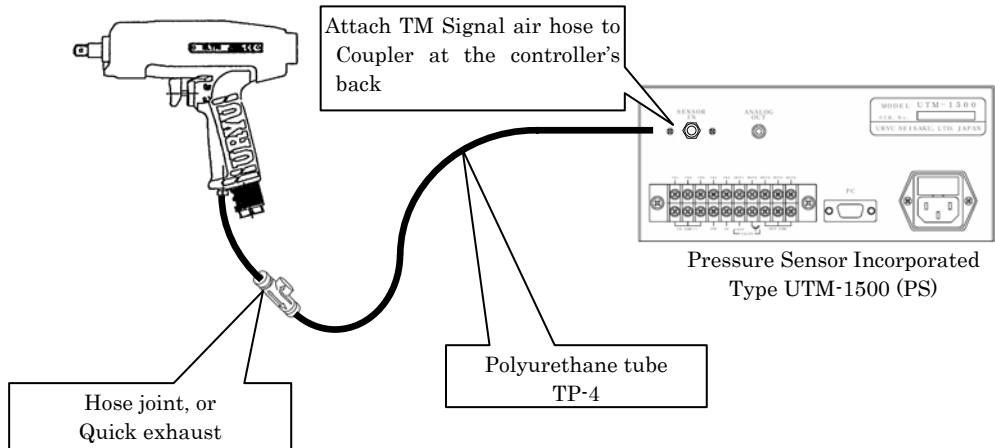

④When using Air-electric Relay

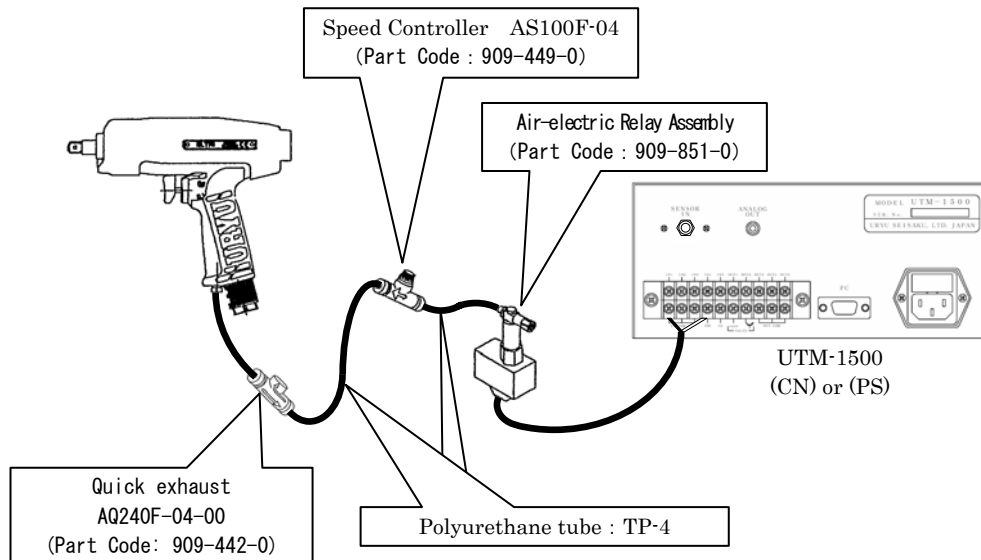

- Place Speed Controller when using Air-electric Relay.
- Both UTM-1500 (CN) and UTM-1500 (PS) are acceptable.
- Allocate PS to Input Terminal Block and hook up the cable from Air-electric Relay.

(2) TM Type Tool

①When using UTM-1500 (RA-CN)

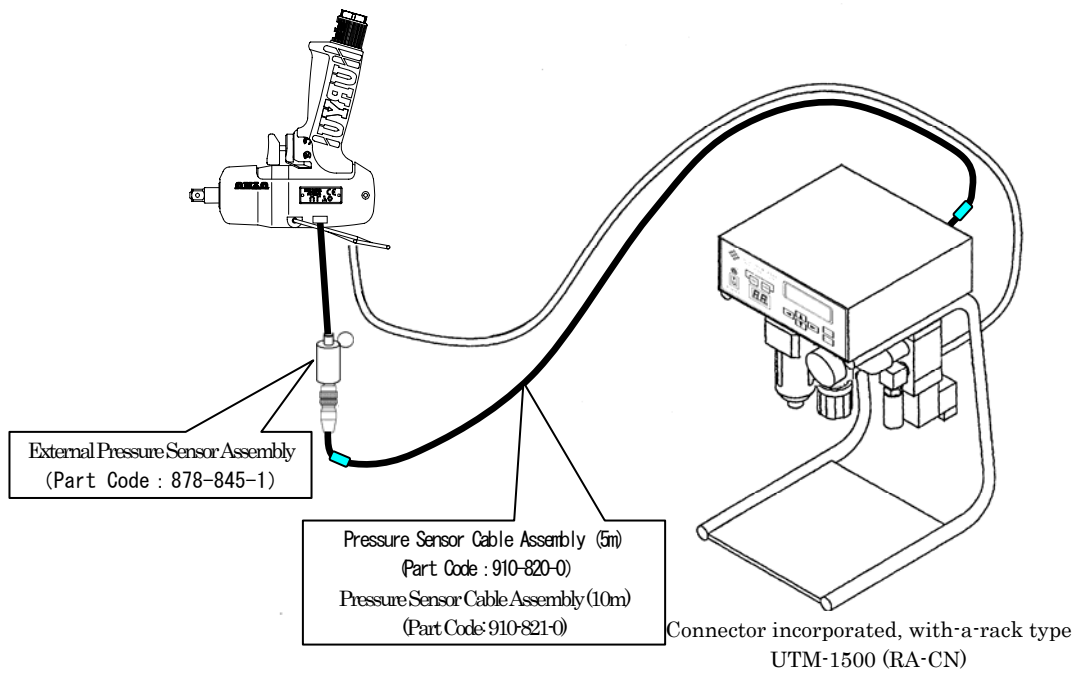

②In the case of without a rack

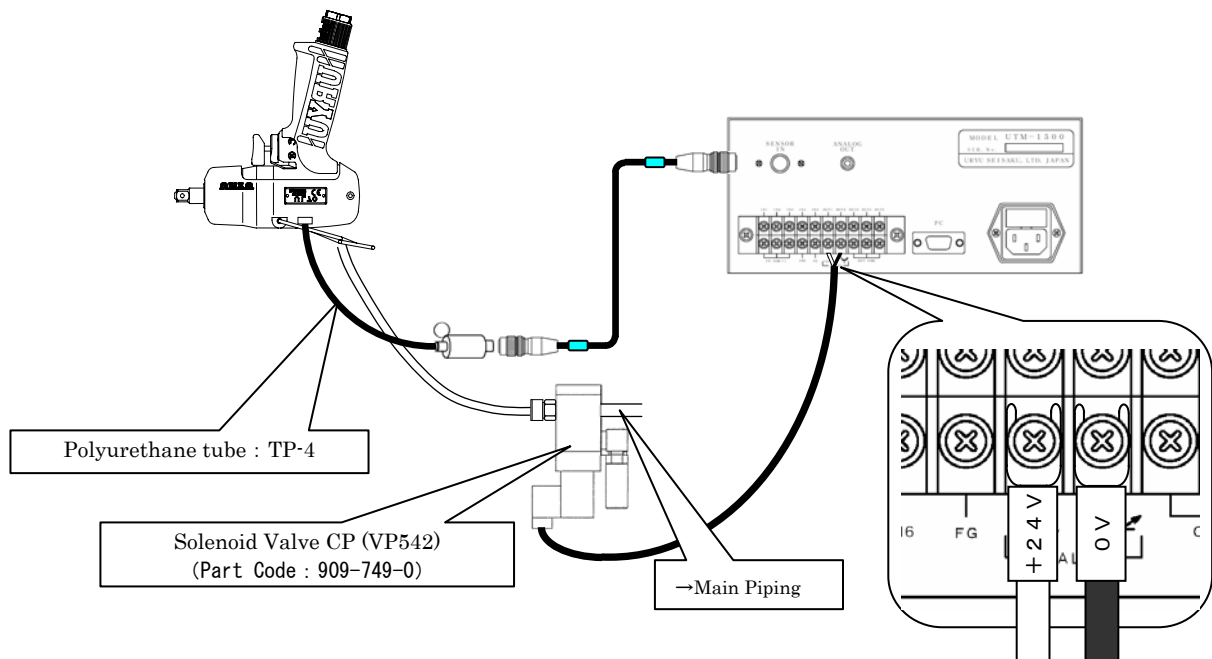

(3) Standard Tool

①When using UTM-1500 (RA-PS)

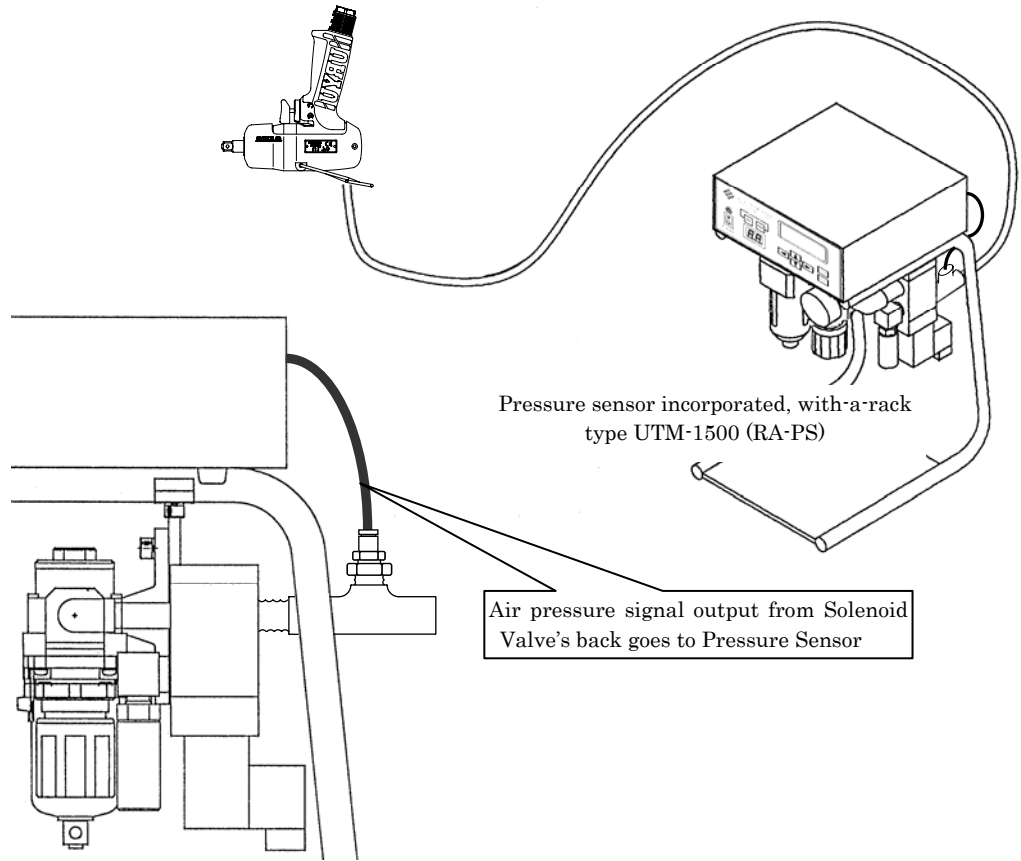

②When using UTM-1500 (CN)

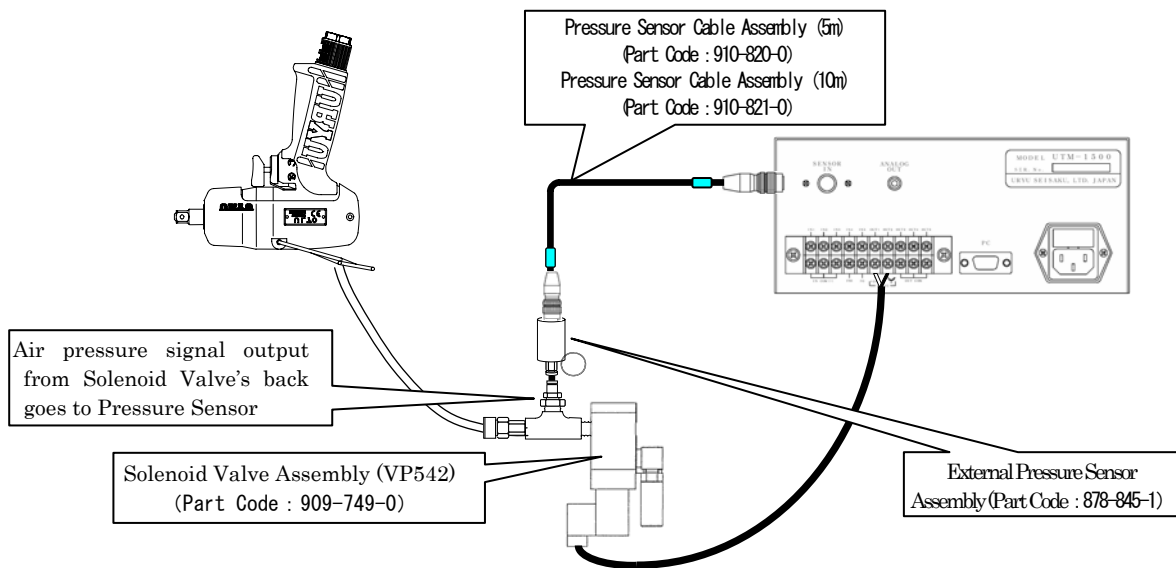

Exterior Features

(1) Front Side

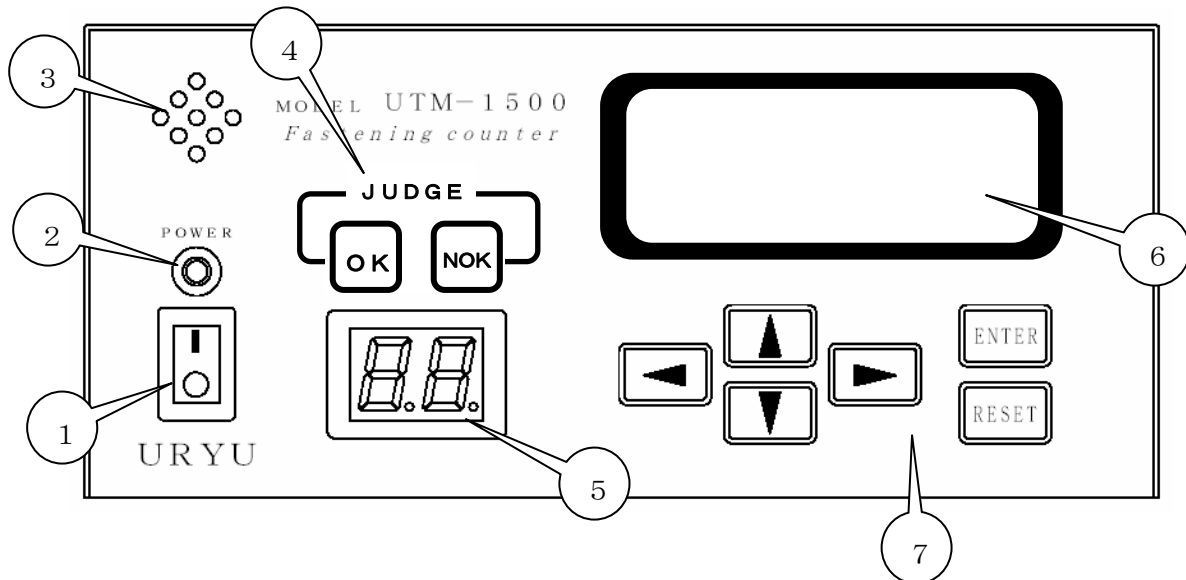

①Power Switch

| : ON

○ : OFF

②Power Lamp (green)

The green LED lamp lights up when the power switch is turned ON.

③Buzzer

The volume of fastening recognition, NOK and Key Operation sound can be adjusted each independently.

Low-tone buzzer can also be used alternatively. (Always use the low-tone buzzer at the maximum 5 volume setting as the buzzer does not produce audible sound with low settings.)

Part Name : Low-tone buzzer unit (Star PMB-06)

Part Number : 910-824-0

④Judgment Lamp

Count OK : OK lamp will light up.

Count NOK : NOK lamp will light up.

Fastening OK : Lamps remain off.

Fastening NOK : NOK lamp will flash.

During MENU screen operation : OK and NOK lamps will light up by turns.

⑤2-digit, 7-segment LED Display

Remaining fastening number will be indicated.

("WORK No." will be indicated if "on a WORK No. basis setting" has been specified on MENU screen.)

⑥LCD (20-digit x 4 lines) Display

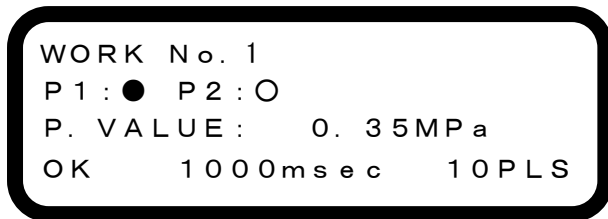

【During measurement】

First Line : Selected WORK No.

Second Line : P1, P2 monitor indication. Blow start, shut-off detecting status will be indicated. ○ means "detecting" and ● means "not detecting".

TOOL TYPE	SHUT-OFF (ULT or other shut-off tools)	TM (TM Type Tool)	NON-SHUT (Standard Tool)
P 1	BLOW START Blow start	LEVER ON Lever "ON"	
P 2	SHUT-OFF Shut-off	BLOW START Blow start	

P 1 : Pressure at Blow start detection monitor

P 2 : Pressure at Shut-off detection monitor

Third Line : Pressure value monitor

Fourth Line : "Judge", "Fastening Time", "Pulse Number."

Judgment : Judgment related to fastening operation including OK, PLS. LOW, NOK)

Fastening Time : Time interval between blow start and shut-off

Pulse No. : Blow number from blow start to shut-off in the case of Shut-off Tool.

Blow number during ON timer is in action in the case of TM Tool/Standard Tool.

※There are times when pulse detection is impossible depending on Tool types and/or working conditions.

⑦Key Switch (for MENU selection and setting value entry)

(2) Back Side

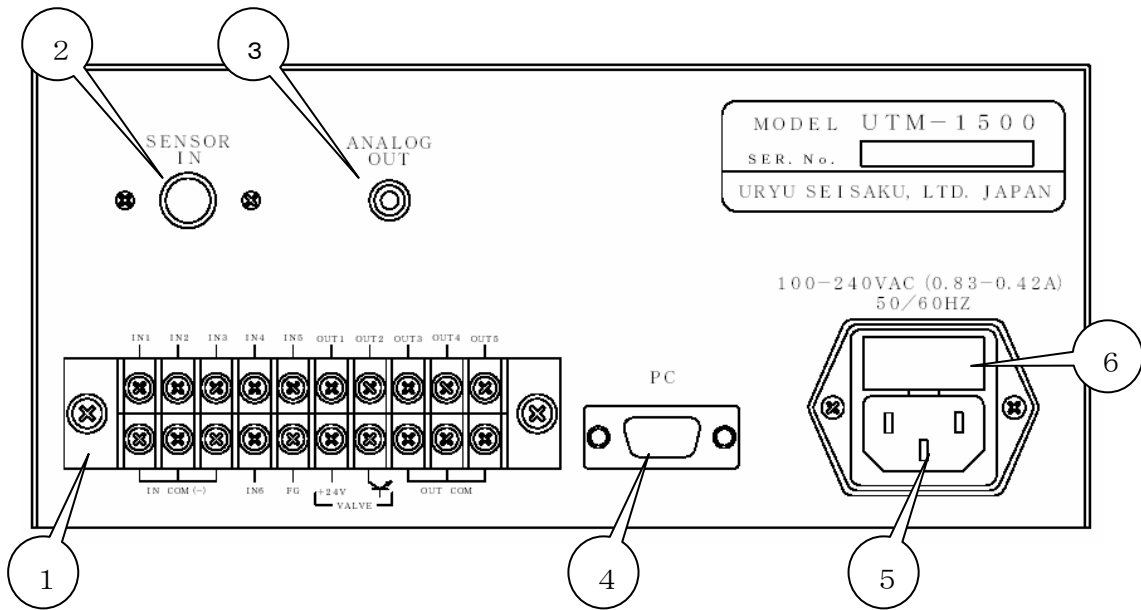

① Terminal Block (detachable)

Wiring to Input Terminal must be under no-voltage conditions.

Wiring to Output Terminal must be less than DC24V.

Always use Y-shape or round crimp-style terminals when wiring.

② Sensor Cable coupling connector (Pressure Sensor can be installed with the connector removed.)

③ ANALOG OUT

Analog signals will be output from Pressure Sensor.

④ PC Connector

Hook up the cable from PC.

⑤ Power cable connector

⑥ Fuse (spare fuse incorporated)

Functions

Self-Diagnosis Function

Self-diagnosis function will run in the main system at power-on.

Software version will be displayed on the second line of LCD display during self-diagnosis.

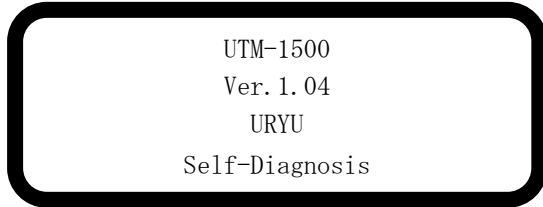

Memory Function

Up to 1,500 fastening data can be saved.

Zero Adjustment

There are cases where sensor output voltage shows a bit different voltage from 0V even though the pressure sensor is under free of pressure conditions. To rectify such deviation, output voltage under no pressure equals 0.0Mpa equation will be memorized through this function.



Procedure:

- Press  + .

Initialization Function

This function will bring System back into factory default settings by initializing old settings and by erasing memory data saved.

Procedure:

- Turn the power on while pressing  + .

7-segment LCD Display - Indicator Lamp Test

7-segment indicator lamps will all light up. 7-segment will turn to “8.8.” and LCD display will be painted black.

- Turn the power on while pressing  key.

Terminal Block Wiring Check Function (P30)

This function is specifically designed to test the terminal block for correct wiring and to see if it is functioning normally.

Input wiring diagnosis : Input signals can be checked.

Output wiring diagnosis : Output signals can be checked.



Settings

Self-diagnosis function will run at power-on. Operation Mode will start when no faulty condition has been detected during the course of Self-diagnosis. Pressing  for more than 3 seconds under Operation Mode will start MENU screen and then Program Mode will be initiated. You may change setting values under Program Mode. Note that Program Mode will render TM Tool or Standard Tool uncontrollable. Consequently, Valve Output will turn into ON status and you may not use Tool during Program Mode.

Press  to return to Operation Mode.

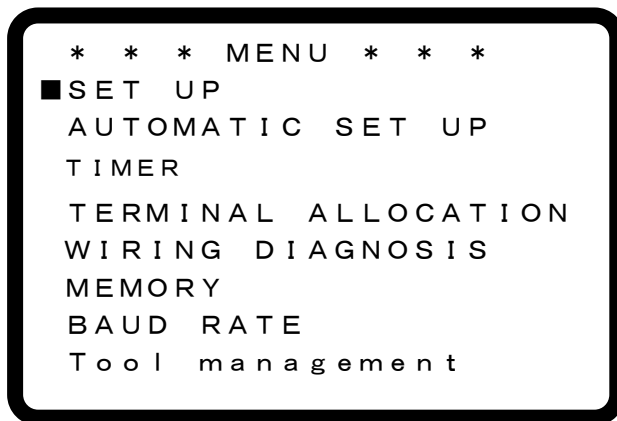
JUDGE OK and NOK lamps will light up by turns under Program Mode.



- Select any item by touching  .
- The current selection accompanies ■ mark on the left.
- Touch  to move to the corresponding Screen.

SET UP

Function Setting

```
* * * SET UP * * *
TOOL : SHUT-OFF TYPE
SENSOR : NO DISPLAY
BLOW START : 0. 10 MPa
SHUT-OFF : 0. 30 MPa
PULSE LV : 0. 000 MPa
CUT PULSE No. : 0
UPPER PULSE No. : 0
LOW PULSE No. : 0
■ COUNT : 99
L. CONT. : LS1
W. SEL. TIMING : NO
ERROR : REFASTENING
CHECK BZ VOL. : 5
NOK BZ VOL. : 5
KEY BZ VOL. : 5
DISPLAY : Standard
```

TOOL (Tool Selection)

Initial Setting : SHUT-OFF TYPE

Select any among three selectable tools; SHUT-OFF TYPE/TM TYPE/NON-SHUT TYPE

- This selection is common among WORK №1 ~ 4.

SHUT-OFF TYPE (Shut-off Tool)

- Tool will stop operation automatically upon completing bolt fastening operation, and then TM Signal will be output.
- When SHUT-OFF TYPE is selected, ON (Valve ON Timer) and OFF (Valve OFF Timer) initial values will become "0" respectively.

TM TYPE (TM Type Tool)

- TM Signal will be output during fastening operation. Tool will not stop operation automatically, and fastening time controlling via UTM will become necessary.
- When Shut-off Tool is selected, Valve ON Timer and Valve OFF Timer initial values will become "700" and "800" respectively.

NON-SHUT TYPE (Standard Tool)

- As TM Signal will not be output in this case, Tool Blow Start will be sensed using Tool's hand pressure. Tool will not stop operation automatically, and fastening time controlling via UTM will become necessary.
- When Standard Tool is selected, ON and OFF initial values will become "700" and "800" respectively.

SENSOR (Pressure Sensor Input Type)

Initial Setting : NO DISPLAY

Select any among three selections; NO DISPLAY/DISPLAY/RELAY BOX

- This selection is common among WORK №1 ~ 4.

NO DISPLAY : Private external Pressure Sensor Assembly. Sensor incorporated in Tool or Controller.

DISPLAY : Pressure sensor with a digital display

RELAY BOX : Select when you use Air-electric Relay (without using Pressure Sensor).

BLOW START/LEVER ON [Mpa] (Blow Start Pressure/ Fastening Start Pressure)

• Measurement Start Pressure

Initial Value	Shut-off Tool	: 0.10
	TM Type Tool	: 0.10
	Standard Tool	: 0.50

Setting Range 0.00~1.00

- When using Shut-off Tool, the corresponding name will be BLOW START, and set a pressure value to effect Tool blow detection.
- When using TM Tool (not Shut-off) or Standard Tool, the corresponding name will be LEVER ON, and set a pressure value to effect Tool free-running detection.
- This setting is common among WORK No. 1~4.

SHUT-OFF/BLOW START [Mpa] (Shut-off Pressure/Blow Start Pressure)

Initial Value	Shut-off Tool	: 0.30
	TM Type Tool	: 0.20
	Standard Tool	: 0.30

Setting Range: 0.00~1.00

- When using Shut-off Tool, the corresponding name will be SHUT-OFF, and set a pressure value to effect Tool Shut-off signal detection.
- When using TM Type or Standard Tool, the corresponding name will be BLOW START, and set a pressure value to effect Tool blow detection.
- This setting is common among WORK No. 1~4.

PULSE LV [Mpa] (Pulse Detection Pressure)

Setting Range : 0.000~1.000

Initial Value : 0.000

- This is a setting to enable pulse detection.
- PULSE Pulses of less than PULSE LV will not be counted.
- Perform setting works under Auto Setting or by referring to waveforms saved on PC.
- This setting is common among WORK No. 1~4.

※Pulse detection will sometimes become impossible in the case that Tool of less pneumatic pressure fluctuation type at pulsation (small tool or the like to be more specific) is in use or depending on work conditions.

CUT PULSE No. (Cut Pulse Number)

Setting Range : 0~999

Initial Value : 0

- In the case of 1~999 setting, Valve Output will take place when the pulse number input reached the preset pulse number to stop Tool.
- In the event that you do not use this function, make this setting 0.
- This setting is common among WORK No. 1~4.

UPPER PULSE No. (Upper Pulse Number)

Setting Range : 0~999

Initial Value : 0

- This is the upper limit for pulse number judgment. When the pulse number measured stepped across the preset number, Pulse HIGH NOK will result.
- This setting is common among WORK No. 1~4.
- In the case of 0 setting, pulse number upper limit judgment will not be performed.

Reaction in the case of Pulse HIGH NOK detection:

- LCD Display : [Pulse High Error]
- Buzzer : ON
- Output Terminal : FAS. NOK will be output

Error Condition Resetting

- In the case that ERROR (refastening at fastening NOK) is set to REFASTENING (fastening NOK clear at refastening operation start), the next fastening operation will reset error conditions:
- RESET key operation or RESET terminal input.

LOW PULSE No. (Lower Pulse Number)

Setting Range : 0~999

Initial Value : 0

- This is the lower limit for pulse number judgment. When Tool becomes shut-off condition before the pulse number measured reached the preset number, Pulse LOW NOK will result.
- This setting is common among WORK No. 1~4.
- In the case of 0 setting, pulse number lower limit judgment will not be performed.

Reaction in the case of Pulse LOW NOK detection:

- LCD Display : [Pulse Low Error]
- Buzzer : ON
- Output Terminal : FAS. NOK will be output

Error Condition Resetting

- In the case that ERROR (refastening at fastening NOK) is set to REFASTENING (fastening NOK clear at refastening operation start), the next fastening operation will reset error conditions:
- RESET key operation or RESET terminal input.

COUNT (Fastening Number)

Initial Value : 99

Setting Range : 0~99

- Set intended fastening number.
- This is on a WORK No. basis setting.

L. CONTR. (Fastening Number Count Operation Mode Selections)

Initial Setting : LS1

- Select Line Control Mode to be used during Fastening Number Count.
- This setting is common among WORK No. 1~4.
- Note that QL Terminal accepts inputs outside the operating range particularly specified using this function.

LS1

- All-the-time fastening number counting down ready condition will be rendered, and judgment will be made on Limit Switch input. COUNT OK judgment will be given when the preset fastening COUNT number is attained, and ready-to-start the next work fastening operation status will be brought about when LS1 has been input and the old fastening number has been cleared. If the preset fastening number is not attained at the time of LS1 input, COUNT NOK judgment will be given. In this case, COUNT OK judgment will result when the remaining fastening operation has been completed.

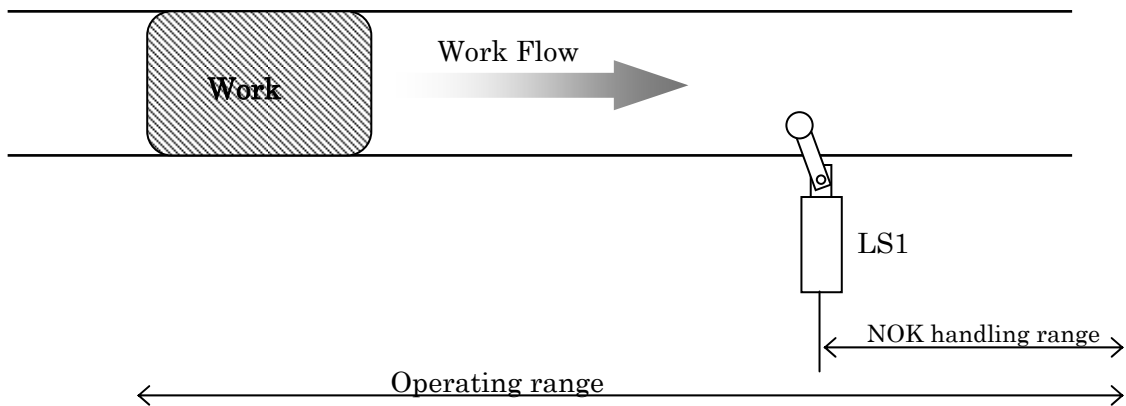

LS1 · LS2

- Fastening operation range will be defined. Operation will start (counting down ready condition) on LS1 input.
- When the preset fastening number is attained before LS2 input, fastening operation will finish.
- COUNT NOK judgment will be given when the preset fastening number is not attained at the time of LS2 input, and in this case, fastening operation will finish when COUNT OK condition resulted through NG handling operation.

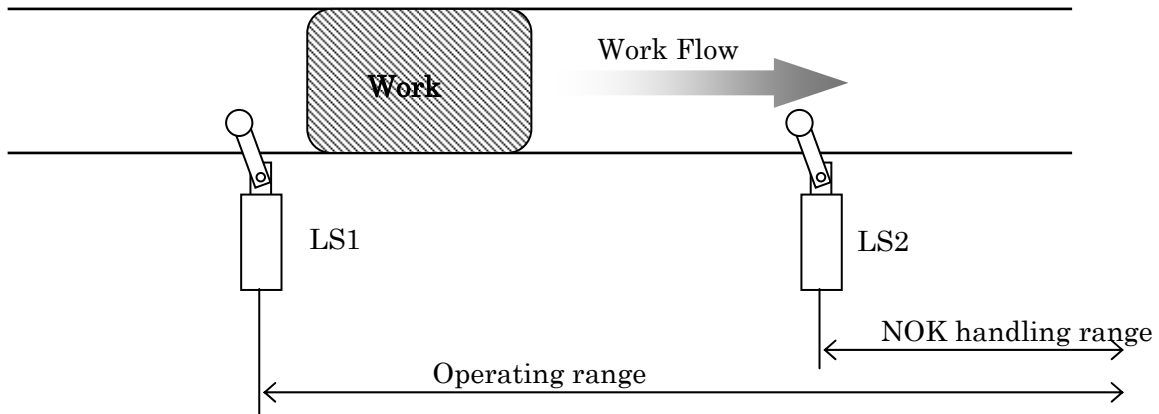

LS1 · LS3 · LS2

- Fastening operation range will be defined. Operation will start (counting down ready condition) on LS1 input. COUNT NOK judgment will be given when the preset fastening number is not attained at the time of LS3 input, and in this case, the range up to LS2 input ON will become NG handling range. Fastening operation will finish at the time of LS2 input.

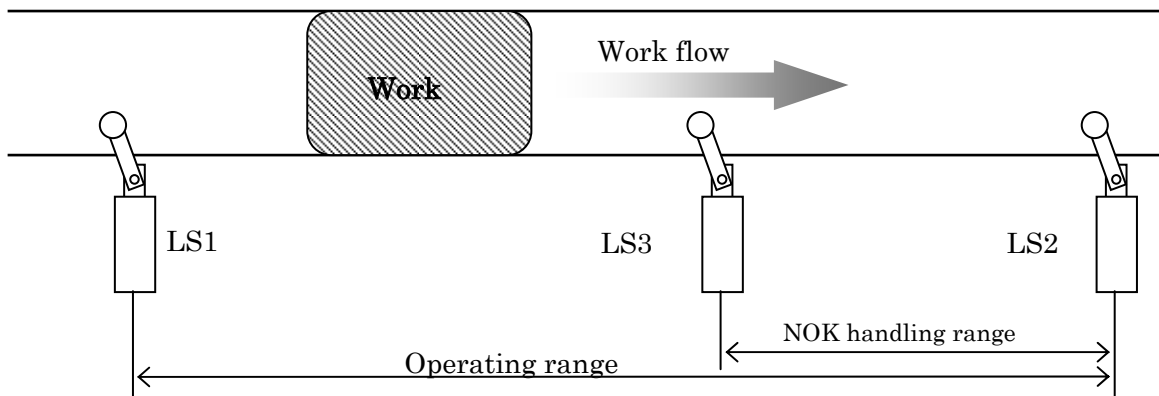

LS1+TIMER

- Fastening operation will start at the time of LS1 input, and the line control timer will also start. When the preset fastening number is attained, COUNT OK will result, and then LS1 input will be accepted only after COUNT OK terminal output (output duration time can be set by using COUNT OK output timer).
- If the line control timer has become time-out before completing the preset fastening number, COUNT NOK will result. In this case, fastening operation will finish when COUNT OK judgment is given through NOK handling.
- Note that COUNT OK terminal output holding (set value: 0) can not be selected when this function is in use.

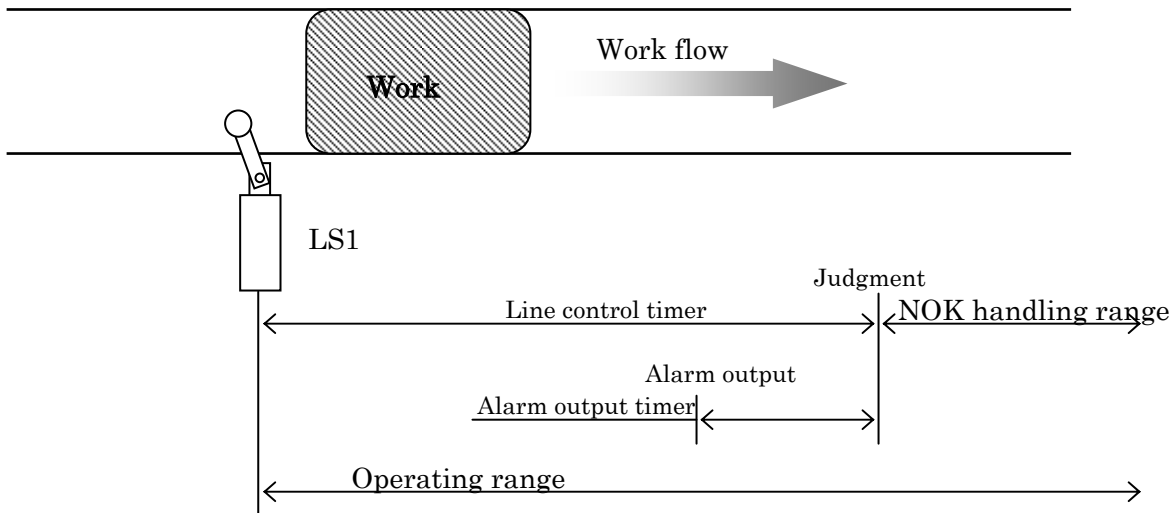

TIMER

- In this method, Limit Switch will not be provided, and the line control timer gets started by utilizing the initial fastening judgment or QL wrench input.
- COUNT OK judgment will be given when the preset fastening number is attained, and the next coming work fastening operation will become ready when COUNT OK output (output duration time can be set by using COUNT OK output timer) is turned OFF.
- If the line control timer has become time-out before completing the preset fastening number, COUNT NOK will result. In this case, fastening operation will finish when COUNT OK judgment is given through NOK handling.
- Note that COUNT OK terminal output holding (set value: 0) can not be selected when this function is in use.

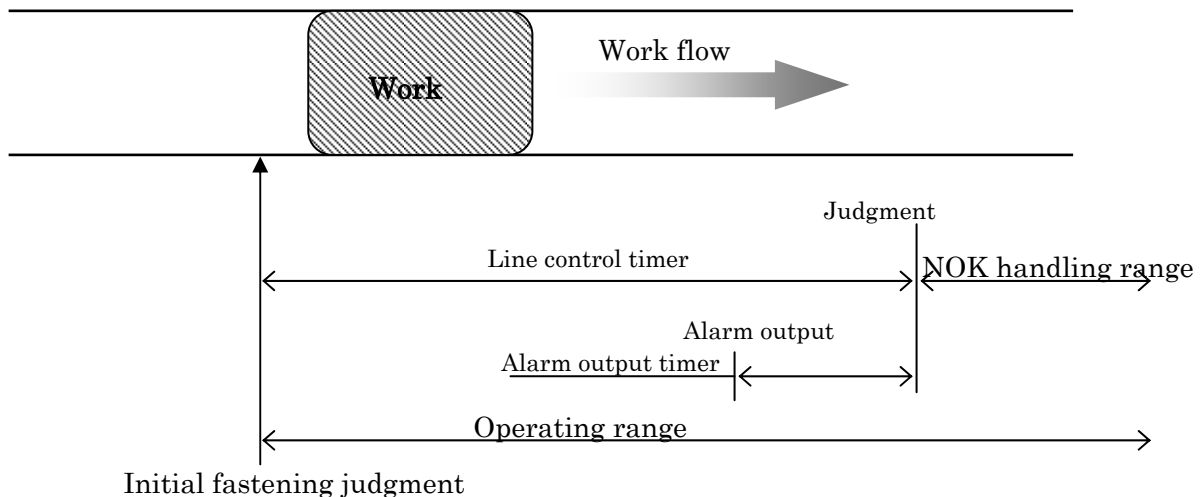

W. SELECT

- Fastening operation will start upon WORK SELECT 1~4 input.
- When the preset fastening number is attained, Work No. specific COUNT OK will be output (output duration time can be set by using COUNT OK output timer).
- When the preset fastening number is not attained at the time of WORK switching input OFF condition, COUNT NOK will result.
- In addition, when WORK SELECT input is turned OFF before attaining the preset fastening number, COUNT NOK will result.

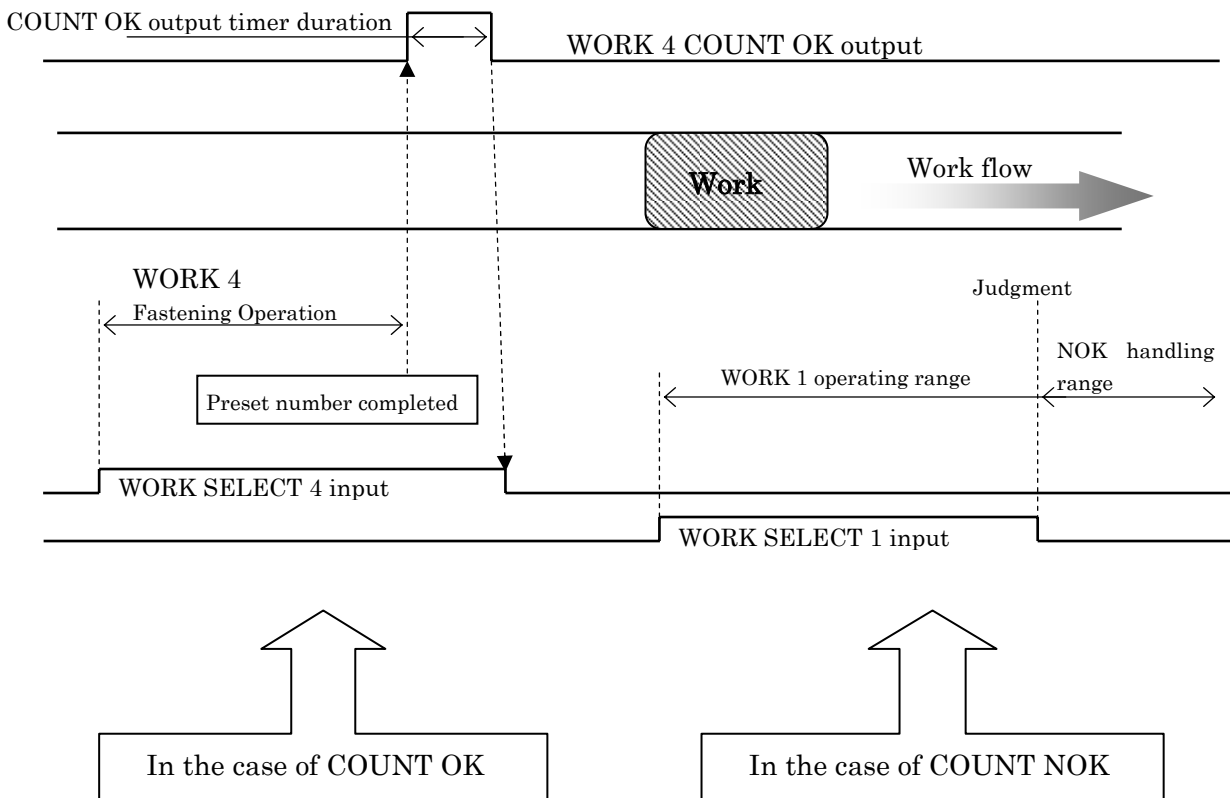

W. SEL. TIMING (WORK No. switching timing)

Initial Setting : NO (without timing)

- This setting is common among WORK No. 1~4.

Particulars

NO (without timing)

- WORK No. switching will take effect immediately after WORK SELECT input condition has been changed.

YES (with timing)

- The following timings will be interposed at the time of WORK No. switching.

- ① At the time of Front Panel RESET key input
- ② At the time of RESET terminal input
- ③ At the time when COUNT OK lamp is turned off.

ERROR (refastening at the time of fastening error)

Initial Setting : REFASTENING (fastening NOK will be cleared upon refastening operation start)

- Select refastening at the occasion of fastening errors:
- This setting is common among WORK No. 1~4.

Particulars

REFASTENING (Fastening NOK clearing at refastening operation start)

- Fastening error will be cleared at the time of refastening operation start.

NO RE-F (refastening will not be accepted until Fastening NOK RESET)

- When a fastening error (initial error/cycle error) occurs under this setting, the next fastening signals cannot be accepted until such error condition has been cleared by inputting Fastening NOK RESET. When TM Type Tool or Standard Tool is in use, VALVE ON status will be kept ON until such error condition has been cleared, and the next fastening operation cannot be accepted without error cancellation.

CHECK BZ VOL. (Fastening Operation Check Buzzer Sound)

Initial Value : 5

Setting Range : 0~5

- This buzzer sounds to give operators a count-down signal at the time of Fastening OK or QL input.
0: no sound 1: low-volume~5: high-volume
- The buzzer will turn ON for 1-pulse duration at count-down and turn ON for 2-pulse duration at Count OK.
- This setting is common among WORK No. 1~4.
- Be sure to set to Level 5 when you use the low-tone buzzer.

NOK BZ VOL. (NOK Buzzer Sound)

Initial Value : 5

Setting Range : 0~5

- This buzzer sounds to give operators Fastening NOK or Count NOK signals.
0: no sound 1: low-volume~5: high-volume
- This setting is common among WORK No. 1~4.
- Be sure to set to Level 5 when you use the low-tone buzzer.

KEY BZ VOL. (Buzzer Sound at Key Operation)

Initial Value : 5

Setting Range : 0~5

- This buzzer sounds to give operators power-on and/or key-in signals.
0: no sound 1: low-volume~5: high-volume
- This setting is common among WORK No. 1~4.
- Be sure to set to Level 5 when you use the low-tone buzzer.

DISPLAY (LCD Display Selection)

Select any of the following LCD display options to view under Operation Mode:

Selections: Standard (initial setting) or Fas. time

Standard

- Items on display

WORK No., Pressure Detecting Status, Current Pressure Value, Judgment, Fastening Time and Pulse No.

[Example]

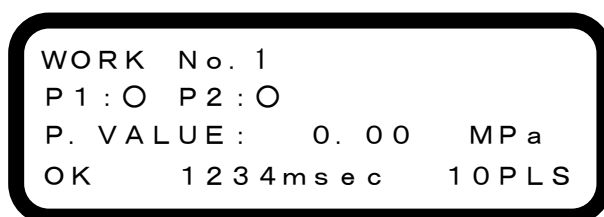



Fas. Time (Fastening time)

- Items on display

Only fastening time will be displayed at full scale using all 4 lines.

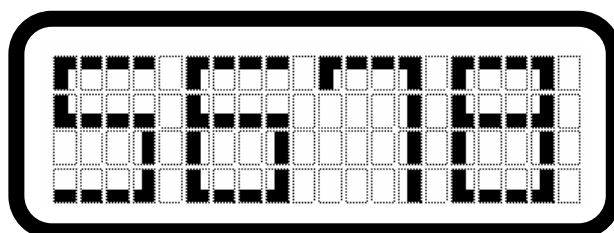
[Example]



Display switching is allowable also under Operation Mode. Switch to “Fas. Time” by pressing  for longer than 2 seconds and switch to “Standard” by pressing  for longer than 2 seconds.

AUTOMATIC SET UP (automatic setting)

This Automatic Set Up function performs automatic pressure setting by utilizing the pressure variation obtained through Tool free running and practical fastening operation.

(1) Tool Selection

```
*  AUTOMATIC SET UP  *
■ SHUT-OFF
  TM TYPE
  NON-SHUT TYPE
```

① Select Tool you will use and press  key.

(2) Measurement of Pressure at Free Running

```
*  AUTOMATIC SET UP  *
Air Pat Free Running
0.00 Mpa
```

① Run your Tool for 2~3 seconds under no-load, and then release the lever.

(Run your Tool with the socket and bit removed from Tool end.)

② The buzzer sounds when the controller has read pressure value, and the measured pressure value will be on display.

③ Run your Tool again under no-load when re-measurement is necessary.

④ Press  key when pressure value is obtained normally.

(3) Measurement of Blow Pressure / Shut-off Pressure (in the case of SHUT-OFF selection)

```
*  AUTOMATIC SET UP  *
Air P 's during Blows
0.00Mpa~0.00Mpa
0.00Mpa
```

Blow Pressure Range

Shut-off Pressure

① Start fastening operation with a bolt seated. In the case that Shut-off Tool is in use, perform fastening operation until shut-off.

② The buzzer sounds when the controller has read pressure values, and the measured pressure values will be on display.

③ Return to ① when re-measurement is necessary, and press  key when pressure values are obtained normally.

(4) Set Value Display

```
LEVER ON   : 0. ** Mpa
SHUT-OFF   : 0. ** Mpa
PULSE LV   : 0. *** Mpa
1-PULSE    : **** msec
```

① Pressing  key will call up the previous screen (Blow/Shut-off Pressure Measurement).

② Pressing  key will call up MENU screen upon rewriting the setting values.

③ You may perform re-measurement also at this stage by repeating fastening operation.

TIMER

* * * TIMER * * *	
■ INITIAL. E. :	0 msec
CYCLE. E. :	0 msec
L. CONTR. :	100 sec
WARNING :	0 msec
ON :	700 msec
OFF :	800 msec
OK :	1000 msec
COUNT OK :	1000 msec
1-PULSE :	10.0 msec
QL time :	100 msec

①INITIAL. E [msec] (initial error detection timer)

Initial Value : 0

Setting Range : 0~9999 (0 setting when you do not use this function)

Functions

- Timer will start at the time when the pressure attained the preset fastening start pressure, and error will be detected when the preset shut-off pressure is attained before time-out.
- This is on-a-WORK No. basis setting.

②CYCLE. E. [msec] (cycle error detection timer)

Initial Value : 0

Setting Range : 0~9999 (0 setting when you do not use this function.)

Functions

- Timer will start at the time when the pressure attained the preset fastening start pressure, and cycle error will be detected before the preset shut-off pressure is attained.
- This is on-a-WORK No. basis setting.

③L. CONTR. [sec] (line control timer)

Initial Value : 100

Setting Range : 1~999

Functions

- This function is used to effect fastening number count operation based on timer control.
- This is on-a-WORK No. basis setting.

④WARNING [sec] (alarm output timer)

Initial Value : 0

Setting Range : 0~999

- Use this function when an alarm output before line control timer time-out timing is necessary.
- Terminal outputs allocated to alarm outputs will turn ON before the alarm output timer preset time from the line control timer time-out. Alarm outputs will turn OFF at the time of line control timer time-out timing or at the time of Count OK (line control judgment).
- This is on-a-WORK No. basis setting.

⑤ON [msec] (ON Timer)

Initial Value : 0

Setting Range : 0~9999

- This is on-a-WORK No. basis setting.

⑥OFF [msec] (OFF Timer)

Initial Value : 0

Setting Range : 0~9999

- This is on-a-WORK No. basis setting.

⑦OK [msec] (Fastening OK Output Timer)

Initial Value : 1000

Setting Range : 0~9999 (Output will be held up to the next fastening start point in the case of 0 setting.)

Functions

- This is fastening OK terminal's output time
- Output will be turned OFF even before time-out timing in the case that the next fastening operation gets started during Fastening OK Output.
- This is on-a-WORK No. basis setting.

⑧COUNT OK [msec] (Count OK Output Timer)

Initial Value : 1000

Setting Range : 0~9999 (Output will be held up to the next fastening start point in the case of 0 setting.)

Functions

- This is Count OK terminal's output time
- Output time will be 1000msec at the maximum when the next fastening operation got started during Count OK output or when Count OK resulted after Count NOK. (In the case of less than 1000msec settings, Turn OFF at the time when the preset time has been attained.)
- This is on a WORK No. basis setting

⑨1-PULSE [msec] (Lowest Pulse Range)

Setting Range : 0~9999

Functions

- This is Pulse Detection Timer.
- Pulses with a pulse fall time of longer than 1-pulse will be judged as a pulse.
- Perform setting works under Auto Setting or by referring to waveforms saved on PC.
- ✘Pulse detection will sometimes become impossible in the case that Tool of less pneumatic pressure fluctuation type at pulsation (small tool or the like to be more specific) is in use or depending on work conditions.

⑩QL time [msec] (QL Wrench Anti-chattering Timer)

Setting Range : 0~9999

Functions

- This setting is specifically designed to avoid duplicate count at one time QL due to chattering during QL wrench operation.
- Even though Input is turned ON within the preset time after QL terminal Input is turned OFF, countdown will not be performed.

TERMINAL ALLOCATION (Terminal Block Input/Output Alternatives)

(1) Choice among terminal block input alternatives

- Choose input signal alternatives for use in Input Terminal Block IN1~6.
- This setting is common among WORK No. 1~4.

Initial Setting

IN 1 : LS 1 IN 2 : RESET IN 3 : NOK RESET
 IN 4 : QL IN 5 : WORK SELECT A IN 6 : WORK SELECT B

Alternatives (Pick up 6 among the following alternatives)

● LS 1 ● LS 2 ● LS 3 ● RESET ● NOK RESET
 ● QL ● PASS ● W. SEL. A ● W. SEL. B
 ● W. SEL. 1 ~ W. SEL. 4 ● PS

Particulars

LS1/LS2/LS3

- Limit Switch 1~3. These inputs are used for line control. Refer to P16~19 for more details on Line Control.

RESET

- Count balance/judgment, fastening judgment and others will be cleared entirely and System will be placed in the initial state at power-on.

NOK RESET

- Fastening NOK status will be cleared. Fastening error conditions like an initial error and cycle error will be cleared.

QL

- Fastening numbers remained due to Tool breakdown or inadvertent fastening omission will be counted down when additional fastening operation has been performed with a micro-switch installed Torque Wrench connected to QL terminal.
- It will be counted down regardless of operating range.

PASS

- Inputting PASS will forcefully bring about COUNT OK status.

WORK SELECT A WORK SELECT B

- These inputs are used to allow work number selection and useful to switch 4 types of works with 2 inputs.
- WORK No. Selection Patterns

WORK No.	WORK SELECT-Input Status	
	A	B
1	OFF	OFF
2	ON	OFF
3	OFF	ON
4	ON	ON

WORK SELECT 1~4

- These inputs are used to allow work number selection and useful to switch 4 types of works with 4 inputs.
- WORK No. Selection Patterns

WORK No.	WORK SELECT-Input Status			
	1	2	3	4
1	ON	OFF	OFF	OFF
2	OFF	ON	OFF	OFF
3	OFF	OFF	ON	OFF
4	OFF	OFF	OFF	ON

- PS • For Air-electric Relay signal inputting.

(1) Choice among terminal block output alternatives

- Choose output signal alternatives for use in Output Terminal Block OUT1~5.
- This setting is common among WORK No. 1~4.

Initial Setting

OUT 1 : COUNT OK
OUT 2 : COUNT NOK
OUT 3 : OK (Fastening OK)
OUT 4 : NOK (Fastening NOK)
OUT 5 : BUZZER (Buzzer Output)

Alternatives (Pick up 5 among the following alternatives)

●COUNT OK ●COUNT NOK ●OK ●NOK
●BUZZER ●WARNING
●W. 1. C. OK ●W. 2. C. OK ●W. 3. C. OK ●W. 4. C. OK
●CYCLE COUNT 1 ●CYCLE COUNT 2
●PULSE NOS. 1 ●PULSE NOS. 2

Particulars

COUNT OK

- COUNT OK external output signal
- Output duration can be set on Count OK Output Time Timer.

COUNT NOK

- COUNT NOK external output signal. This signal will be output when the predetermined fastening number has not been attained before judgment.
- This output signal will be kept on during COUNT NOK.
- This output signal remains on until the remaining fastening number has been cleared by adding fastening operation or OK condition has resulted by using PASS or NOK status has been cleared by RESET inputting.

OK

- Fastening OK external output signal
- Output duration can be set on Fastening OK Output Time Timer.

NOK (Fastening NOK)

- This signal will be output at the time of an initial or cycle error.
- This output signal remains on until Fastening OK will be given by performing additional fastening operation or error conditions have been cleared by RESET or Fastening NOK RESET inputting.

BUZZER (output for Buzzer)

- Use this option when an external buzzer will be used.
- Signal output ON timing is the same as the buzzer mounted on System. This buzzer does not produce sound at the time of key operation.

WARNING (alarm output)

- This signal will be output from the Warning Output Timer's time-out to Count OK or to Line Control Timer's time-out.

W. ※. C. OK (WORK ※ COUNT OK) ※ : 1 ~ 4

- Select this output when COUNT OK output becomes necessary on a Work No. basis.

CYC. COUNT 1/2 PULS. NOS. 1/2

- This signal will be output when Cycle Count or Cumulative Pulse attained the value preset using Tool management OUT SET.

WIRING DIAGNOSIS (Terminal Block Wiring Diagnosis)

Wiring diagnosis will be performed through monitoring input status of external wires mated to UTM-1500 Input Terminal Block and through Output Terminal Block forced output.

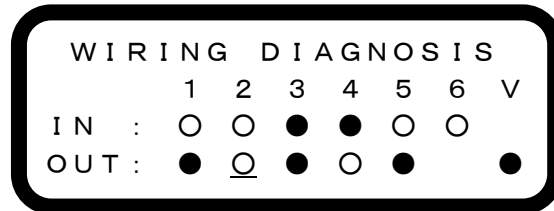

Display Layout

1 ~ 6 : Terminal Block No. (I N 1 ~ 6 • O U T 1 ~ 5)

V : V A L V E Terminal



○ : Terminal's input or output is OFF condition.

● : Terminal's input or output is ON condition.

(1) Input Wiring Diagnosis

- ○ indicate the absence of Terminal Block input
- ● indicate the presence of Terminal Block input



(2) Output Wiring Diagnosis

- Select any of the terminals by touching  . The selected terminal will accompany “_” at the bottom.
- Press  key to switch between the selected output terminal's ON/OFF.
- At the start of WIRING DIAGNOSIS screen, OUT 1~5 will be under OFF “○” state and VALVE will be under ON “●” status.

MEMORY

```
* * * MEMORY * * *  
■WORK      : 1 (125)  
DISPLAY    : DATA  
ERASE      : 1
```

WORK

Make a choice among 1, 2, 3, 4, and ALL alternatives by using   keys and specify WORK No. to call up on DISPLAY column.

When ALL is selected, data pertaining to WORK 1~4 will be displayed altogether.

Numbers to be shown in () indicate data number.

DISPLAY



Select any of the items to call up.

DATA : Numeric data in memory will be displayed.

ANALYSIS : Mean values and/or sigma values will be displayed.

• When  is pressed down, the particulars of the item selected at DISPLAY column according to the Work No. selected at WORK column will be displayed.

ERASE

Make a choice among 1, 2, 3, 4, and ALL (1~4 all inclusive) by using   keys and specify WORK No. of which memory data you intend to erase.

When  is pressed, memory data corresponding to the selected WORK No. will be erased.

BAUD RATE (transmission speed)

```
* * BAUD RATE * *  
BAUD RATE : 38400bps
```

Set data transmission speed matching PC you will use.

Initial Value : 38400 [bps]

Setting Values : 19200, 38400, 57600, 115200

Tool management (tool management)

This function is specifically designed to notify operators of Tool maintenance timing, and when the preset Cycle Count or Cumulative Count has been attained, the timing will be notified through the means of LCD display, Buzzer and Terminal Block output.

- Cycle Count : Current total fastening number of Tool now in use.
"CYC. COUNT" will be indicated on LCD display.
- Cumulative Count : Current total pulse number of Tool now in use.
"PULS. NOS." will be indicated on LCD display.



(1) TOOL

Make entries necessary to specify Tool; including Tool No. and Model.

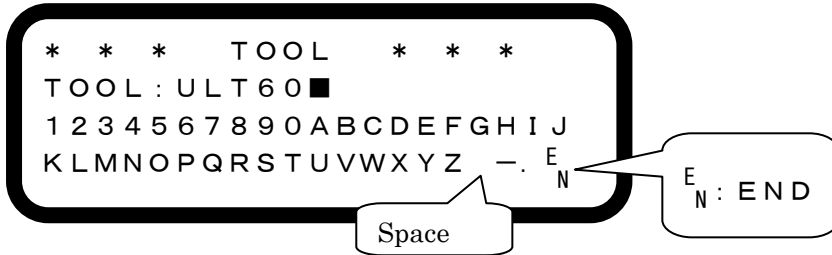

How to make entries

- Put the cursor on any alphanumeric, space, “-” and “.” character arranged on the 3rd and 4th lines by moving the arrow key and press key. Then the character you selected will be put on the cursor position on the TOOL column on the 2nd line.
- To erase the last character of TOOL column, touch RESET key.
- To return to Tool Management MENU screen, press key while putting the cursor on END.
- Up to 15 characters can be entered.

(2) OUT SET

Enter Cycle Count and Cumulative Pulse Number intended for maintenance works.

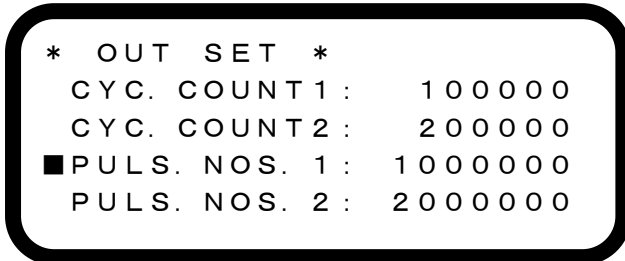

- CYC. COUNT 1 : Cycle Count 1
- CYC. COUNT 2 : Cycle Count 2
- Setting Range : 0~999999

You must make setting CYC. COUNT1 < CYC. COUNT2. Making a check of Tool at CYC. COUNT1 timing and exchanging Tool at CYC. COUNT2 timing is one example of use of this setting.

When you do not use this function, set the numbers “0”.

P U L S . N O S . 1 : Cumulative Pulse 1
P U L S . N O S . 2 : Cumulative Pulse 2
Setting Range : 0~9999999 pulses

You must make setting PULS. NOS. 1 <PULS. NOS. 2. Making a check of Tool at PULS. NOS. 1 timing and exchanging Tool at PULS. NOS. 2 timing is one example of use of this setting. There are times when pulse detection is impossible depending on Tool types and the working conditions and/or according to the distance between Tool and Pressure Sensor. When you do not use this function, set the numbers "0".

Reaction in the event that Cycle Count or Cumulative Pulse number is attained the preset values:

①Window Display

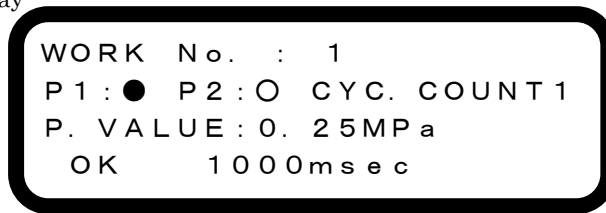

- Corresponding messages like "CYC. COUNT1" or "PULS. NOS.2" will flash on the right of "P 1 : ● P 2 : ○". (Messages to display can be altered on your PC.)
- When CYC. COUNT and PULS. NOS. were output at one time, CYC. COUNT and PULS. NOS. messages will be displayed by turns.

②Buzzer

- When CYC. COUNT1, PULS. NOS. 1 has been attained, the buzzer will turn ON for 1 second and OFF for 1 second repeatedly until you press key.
- When CYC. COUNT2, PULS. NOS.2 has been attained, the buzzer will be kept ON until you press key.

③Terminal Block Output

In the case that the following output items were allocated to Terminal Block as explained earlier in "TERMINAL ALLCATION" section, outputs will be produced when Cycle Count and Cumulative Pulse attained preset values.

```
CYCLE COUNT 1  
CYCLE COUNT 2  
PULSE NOS. 1  
PULSE NOS. 2
```

(3) CUMULATIVE COUNT

Current Cycle Count and Cumulative Pulse Number Display and Clear:

```
* CUMULATIVE COUNT *
■ CYC. COUNT : 30000
PULS. NOS. : 200000
CLEAR
```

CYC. COUNT : Current cycle count
PULS. NOS. : Current cumulative pulse number
CLEAR : Cycle count and cumulative pulse number clearing



- Selecting CLEAR will call up the following window.
- Selecting YES will clear the current cycle count and cumulative pulse number and then call back CUMULATIVE COUNT screen.
- Selecting NO will call back CUMULATIVE COUNT screen without clearing the numbers.

```
ERASE COUNT DATA
CONFIRM AND GO ON!
■ NO
YES
```



Pressure Value Setting

Pressure value setting without using Automatic Setting Function



(1) In the case of Shut-off Tool (TM)

- Connect Tool in the first place
- Touch  key for more than 3 seconds and start “MENU” screen.
- Set TOOL to SHUT-OFF TYPE on “SET UP” screen.
- Then, select “SENSOR”. Select “NO DISPLAY” when a private pressure sensor will be used and select “DISPLAY” when a digital pressure sensor will be used.
- Return to “MENU” screen by touching  key, and touch  key again to return to the measurement screen.
- Read Free Running, Blow and Shut-off pressure values on the measurement screen.
- Enter a midrange value between Free Running and Blow pressures in the “LEVER ON” column on the “SET UP” screen.
- Enter a midrange value between Blow and Shut-off pressures in the “SHUT-OFF” column.
- Check operating conditions on the measurement screen.

(2) In the case of TM Type Tool

- Connect Tool in the first place.
- Touch  key for more than 3 seconds and start “MENU” screen.
- Set TOOL to TM TYPE on “SET UP” screen.
- Then, select “SENSOR”.
- Return to “MENU” screen by touching  key, and touch  key again to return to the measurement screen.
- Read Free Running and Blow pressure values on the measurement screen.
- Enter a value not exceeding Free Running pressure in LEVER ON column on “SET UP” screen.
- Enter a midrange value between Free Running and Blow pressures in the “BLOW START” column.
- Check operating conditions on the measurement screen.

(3) In the case of Standard Tool

- Connect Tool in the first place.
- Touch  key for more than 3 seconds and start “MENU” screen.
- Set TOOL to NON-SHUT TYPE on “SET UP” screen.
- Then, select “SENSOR”.
- Return to “MENU” screen by touching  key, and touch  key again to return to the measurement screen.
- Read Tool Stop, Free Running and Blow pressure values on the measurement screen.
- Enter a midrange value between Tool Stop and Blow pressures in the “LEVER ON” column on “SET UP” screen.
- Enter a midrange value between Free Running and Blow pressures in the “BLOW START” column.
- Check operating conditions on the measurement screen.



AIMCO

1204 E. Maple Rd.
Troy, MI 48083

(800) 852-1368
FAX (800) 582-9015

CORPORATE HEADQUARTERS
10000 S.E. Pine St.
Portland, OR 97216

(800) 852-1368
FAX (800) 582-9015

Ave. Morones Prieto 2110 Pte.
Col. Loma Larga
Monterrey, NL CP 64710, Mexico
52-81 1001-1600
FAX 52-81 1001-1630