

ALPHA 140MC OIL-PULSE WRENCH

EXPLODED VIEW

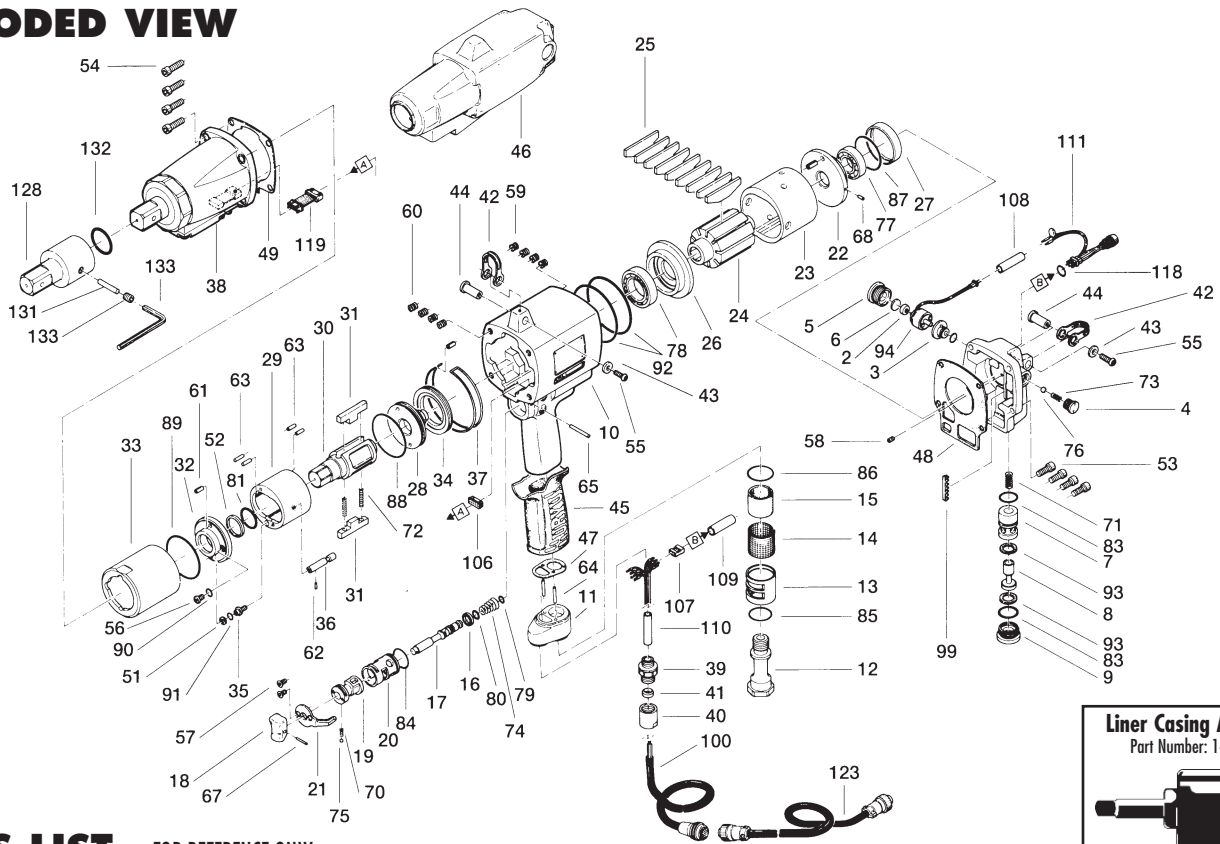

PARTS LIST — FOR REFERENCE ONLY

Index Number	Part Number	Description	Qty.	Index Number	Part Number	Description	Qty.	Index Number	Part Number	Description	Qty.
1	149-012-9	Head Cover	1	39	149-079-2	Connector	1	78	982-906-0	Ball Bearing (6905)	1
2	193-120-6	Valve Packing Spacer	1	40	149-018-2	Cap	1	79	990-002-0	O-Ring (P4)	1
3	193-147-6	Stop Valve Bushing	1	41	149-562-2	Stopper	1	80	990-004-0	O-Ring (P6)	1
4	193-148-6	Stop Valve Cover	1	42	195-790-9	Suspension Ring	1	81	990-160-0	O-Ring (P21) NTN	1
5	193-149-6	Stop Valve Plug	1	43	149-791-9	Suspension Ring Spacer	1	82	990-905-0	O-Ring (SNS-7)	1
6	193-872-6	Valve Packing	1	44	149-796-9	Suspension Ring Bushing	1	83	990-914-0	O-Ring (SNS-16)	1
7	149-253-9	Shut-Off Valve Bushing	1	45	173-842-0	Handle Cover	1	84	990-916-0	O-Ring (SNS-18)	1
8	149-254-9	Shut-Off Valve	1	46	149-840-9	Handle Protector	1	85	990-918-0	O-Ring (SNS-20)	1
9	149-927-9	Shut-Off Valve Cover	1	47	149-850-7	Handle Connector Packing	1	86	990-920-0	O-Ring (SNS-25)	1
10	149-025-9	Handle	1	48	149-853-9	Head Cover Packing	1	87	990-929-0	O-Ring (SNS-36)	1
11	149-035-7	Handle Connector	1	49	149-867-9	Front Casing Packing	1	88	990-936-0	O-Ring (SNS-45)	1
12	149-091-7	Air Inlet Bushing	1	51	944-205-0	Supporting Ring (5.1 X 7 X 1)	1	89	990-937-0	O-Ring (SNS-46)	1
13	163-780-3	Exhaust Stack	1	52	944-221-0	Supporting Ring (20.9 X 24.72 X 1.25)	1	90	990-971-0	O-Ring (SNS-3) NOK	1
14	163-042-3	Silencer	1	53	945-118-0	Allen Head Bolt (M5 X 18)	4	91	990-972-0	O-Ring (SNS-4) NOK	1
15	163-835-3	Filter (K50)	1	54	945-220-0	Allen Head Bolt (M6 X 20)	4	92	990-990-0	O-Ring (SNS-65)	2
16	163-100-3	Valve	1	55	945-943-0	Hexagon Round Head Bolt (M4 X 8)	2	93	996-431-0	Urethane Packing	2
17	163-104-3	Valve Rod	1	56	945-942-0	Hexagon Round head Bolt (M4 X 65)	1	94	909-915-0	Solenoid Valve Assembly	1
18	177-107-5	Valve Lever	1	57	948-423-0	Allen Flush Head Screw (M3 X 6)	2	99	909-486-0	Free Bushing (KG-024)	1
19	152-210-4	Reverse Valve	1	58	954-005-0	Allen Head Cone Point Screw (M3 X 5)	1	100	910-250-0	Joint Cable Assembly	1
20	163-211-3	Reverse Valve Bushing	1	59	965-011-0	Heli-Sert (M5 X 1.5D)	4	106	909-91 8-0	Double-Row Socket (DFI 1-1 2DC-2C)	1
21	163-212-3	Reverse Lever	1	60	965-021-0	Heli-Sert (M6 X 1.5D)	4	107	909-733-0	Connector (RF-06)	1
22	163-285-4	Rear Plate	1	61	969-450-0	Pin (G) (3 X 8)	1	108	909-707-0	Shrink Tube (Ø6 X 30)	1
23	163-286-4	Cylinder	1	62	970-093-0	Pin (H) (2 X 6)	1	109	909-708-0	Shrink Tube (Ø8 X 30)	1
24	163-287-4	Rotor	1	63	970-206-0	Pin (H) (3 X 8)	4	110	909-738-0	Shrink Tube (Ø6 X 40)	1
25	152-288-4	Blade (PC)	1	64	970-208-0	Pin (H) (3 X 10)	2	111	909-549-0	LED Lamp Assembly	1
26	163-289-4	Front Plate	1	65	971-126-0	Pin (2 X 26)	1	111-1	975-079-0	Spacer (12.7 x10.3 x3)	1
27	182-291-7	Rear Plate Spacer	1	66	973-068-0	Roll Pin (2.5 X 8)	1	118	990-907-0	O-Ring (SNS-9)	1
28	195-901-3	Rear Liner Plate	1	67	973-014-0	Roll Pin (2 X 14)	1	119	909-996-0	Sensor Cable Connector Assembly	1
29	175-902-9	Liner	1	68	973-066-0	Roll Pin (2.5 X 6)	1				
30	149-319-9	Anvil	1	69	973-212-0	Roll Pin (4 X 12)	1				
31	195-440-3	Driving Blade	2	70	976-006-0	Spring (3 X 5 X 0.4)	1				
32	175-904-9	Front Liner Plate	1	71	976-459-0	Spring (7 X 21 X 0.7)	1				
33	195-905-3	Liner Casing	1	72	976-795-0	Spring (4.3 X 40.5 X 0.6) WPC	2				
34	195-906-3	Liner Casing Cover	1	73	976-240-0	Spring (4.3 X 14 X 0.4)	1				
35	175-907-9	Relief Valve Spindle	1	74	977-254-0	Cone Spring (10 X 15 X 16)	1				
36	163-970-4	Relief Valve	1	75	981-002-0	Ball (1/8)	1				
37	149-754-9	Clip Guide	1	76	981-024-0	Poll-Urethane Ball (5mm)	1				
38	851-684-1	Sensor Casing Assembly (S22-19)	1	77	982-103-0	Ball Bearing (6003)	1				

ACCESSORIES

123	910-263-0	Sensor Cable Assembly (3F5)	1
128	904-320-0	Extension Bar (3/4SQ 3/4 X 71)	1
130	953-306-0	Allen Head Flat Point Screw (M6 X 6)	1
131	971-324-0	Pin (4 x 24)	1
132	990-018-1	O-Ring (SNS-20)	1
133	939-010-0	Allen Wrench (3mm)	1

FOOTNOTES

- Items in Pulse Repair Kit ALPHA-140MC-PRK

AIMCO also offers a complete line of standard & special adapters, bits, sockets and extensions.





10000 SE PINE,
PORTLAND, OR 97216
503-254-6600
FAX 503-255-2615

When ordering spare parts, please specify tool type, part number and description.

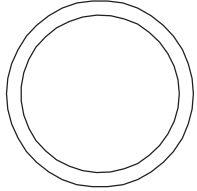

ALPHA-140MC-PRK

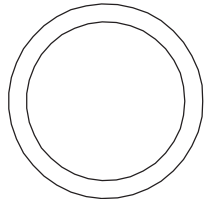
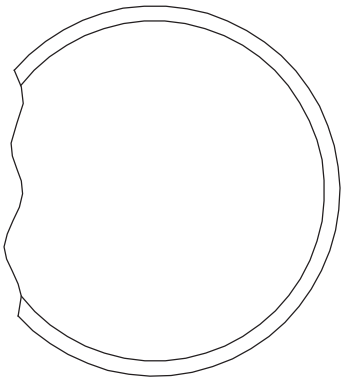
(Kit contains following parts)

#/#	Item Number on Exploded View	Part Number	QTY	Description	Material	Drawing / Scketch
1	51	944-205-0	1	Back Up Ring	Teflon-White	
2	52	944-221-0	1	Support Ring	Teflon-White	
3	72	976-795-0	2	Spring	Spring wire	
4	81	990-160-0	1	O-Ring	Buna-Black	
5	88	990-936-0	1	O-Ring (SNS-45)	Buna-Black	

ALPHA-140MC-PRK

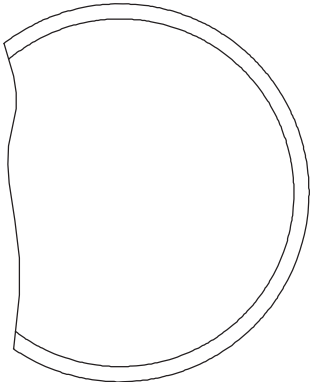
(Kit contains following parts)

#/#	Item Number on Exploded View	Part Number	QTY	Description	Material	Drawing / Scketch
6	89	990-937-0	1	O-Ring (SNS-46)	Buna-Black	
7	90	990-971-0	1	O-Ring	Buna-Black	
8	91	990-972-0	1	O-Ring	Buna-Black	