

**EXPLODED VIEW**

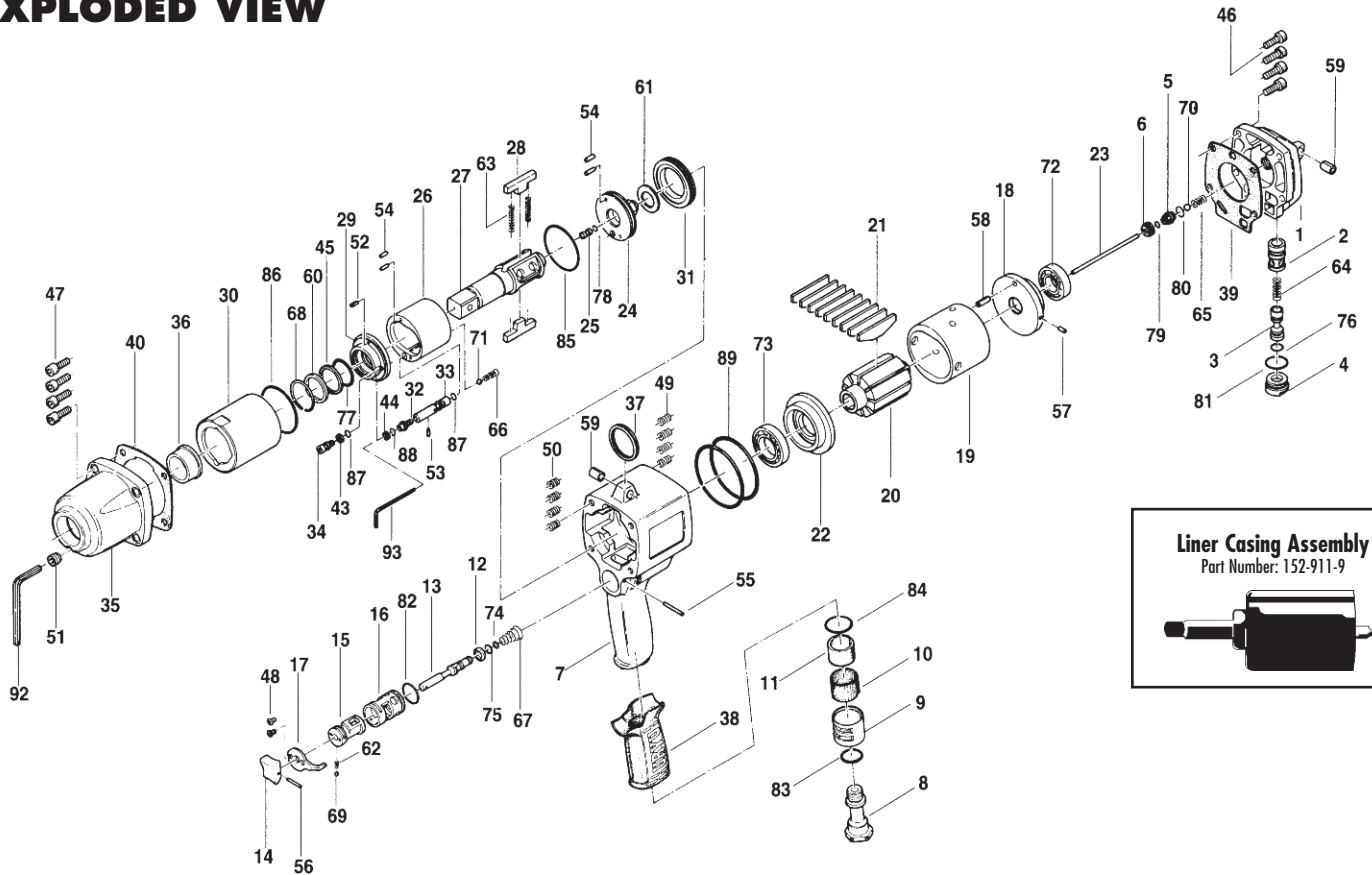

**PARTS LIST — FOR REFERENCE ONLY**

Index Number	Part Number	Description	Qty.	Index Number	Part Number	Description	Qty.	Index Number	Part Number	Description	Qty.
1	152-012-9	Head Cover	1	33	152-970-9	Relief Valve	1	67	977-254-0	Cone Spring (10 x 15 x 16 x 0.9)	1
2	175-253-9	Shut-Off Valve Bushing	1	34	194-742-3	Oil Plate	1	68	978-328-0	Snap Ring (33 x 1.5)	1
3	175-254-9	Shut-Off Valve	1	35	163-439-4	Front Casing	1	69	981-002-0	Ball (1/8)	1
4	175-927-9	Shut-Off Valve Cover	1	36	163-328-4	Anvil Bushing	1	70	981-006-0	Ball (1/4)	1
5	175-968-9	Pilot Valve Retainer	1	37	004-790-2	Suspension Ring	1	71	981-155-0	Ball (3.5mm)	1
6	175-019-9	Valve Cover	1	38	173-842-0	Handle Cover	1	72	982-103-0	Ball Bearing (6003)	1
7	152-025-9	Handle	1	39	152-853-9	Head Cover Packing	1	73	982-906-0	Ball Bearing (6905)	1
8	163-091-4	Air Inlet Bushing	1	40	195-867-3	Front Casing Packing	1	74	990-002-0	O-Ring (P4)	1
9	163-780-3	Exhaust Stack	1	43	944-003-0	Supporting Ring (3 x 5 x 1)	1	75	990-004-0	O-Ring (P6)	1
10	163-042-3	Silencer	1	44	944-205-0	Supporting Ring (5.1 x 7 x 1)	1	76	990-005-0	O-Ring (P7)	1
11	152-835-4	Filter (K100)	1	45	944-225-0	Supporting Ring (25.2 x 29.4 x 1.5)	1	77	990-170-0	O-Ring (ARP-568-120)(NTN)	1
12	163-100-3	Valve	1	46	945-117-0	Allen Head Bolt (M5 x 16)	4	78	990-320-0	O-Ring (ARP-568-003)	1
13	163-104-3	Valve Rod	1	47	945-220-0	Allen Head Bolt (M6 x 20)	4	79	990-901-0	O-Ring (SNS-3)	1
14	177-107-5	Valve Lever	1	48	948-423-0	Allen Flush Head Screw (M3 x 6)	2	80	990-907-0	O-Ring (SNS-9)	1
15	152-210-4	Reverse Valve	1	49	965-011-0	Heli-Sert (M5 x 1.5D)	4	81	990-914-0	O-Ring (SNS-16)	1
16	163-211-3	Reverse Valve Bushing	1	50	965-021-0	Heli-Sert (M6 x 1.5D)	4	82	990-916-0	O-Ring (SNS-18)	1
17	163-212-3	Reverse Lever	1	51	966-100-0	Allen Head Plug (1/8)	1	83	990-918-0	O-Ring (SNS-20)	1
18	163-285-4	Rear Plate	1	52	969-450-0	Pin (G) (3 x 8)	1	84	990-920-0	O-Ring (SNS-25)	1
19	163-286-4	Cylinder	1	53	970-093-0	Pin (H) (2 x 6)	1	85	990-936-0	O-Ring (SNS-45)	1
20	152-287-9	Rotor	1	54	970-206-0	Pin (H) (3 x 8)	4	86	990-937-0	O-Ring (SNS-46)	1
21	152-288-4	Blade (PC)	9	55	971-126-0	Pin (2 x 26)	1	87	990-971-0	O-Ring (SNS-3) (NOK)	2
22	163-289-4	Front Plate	1	56	973-014-0	Roll Pin (2 x 14)	1	88	990-972-0	O-Ring (SNS-4) (NOK)	1
23	152-130-9	Operating Rod	1	57	973-066-0	Roll Pin (2.5 x 6)	1	89	990-990-0	O-Ring (SNS-65)	2
24	152-901-9	Rear Liner Plate	1	58	973-212-0	Roll Pin (4 x 12)	1	<b>ACCESSORIES</b>			
25	175-546-9	Piston	1	59	973-361-0	Roll Pin (8 x 12)	2	92	939-104-0	Allen Wrench (5mm)	1
26	175-902-9	Liner	1	60	975-242-0	Spacer (30 x 25 x 1.5)	1	93	939-109-0	Allen Wrench (2mm) (64 x 64)	1
27	163-319-4	Anvil	1	61	975-812-0	Adjusting Spacer (30 x 17 x T)	1	<b>FOOTNOTES</b>			
28	195-440-3	Driving Blade	2	62	976-006-0	Spring (3 x 5 x 0.4)	1	Note: Liner Casing Assembly = 152-911-9			
29	172-904-5	Front Liner Plate	1	63	976-795-0	Spring (4.3 x 40.5 x 0.6) WPC	2	● Items in Pulse Repair Kit ALPHA-T140-PRK			
30	195-905-3	Liner Casing	1	64	976-143-0	Spring (7 x 18.5 x 0.7)	1				
31	195-906-3	Liner Casing Setter	1	65	976-366-0	Spring (7 x 12.8 x 0.8)	1				
32	175-907-9	Relief Valve Spindle	1	66	977-023-0	Cone Spring (4.1 x 5.1 x 10.7 x 0.7)	1				



**10000 SE PINE,  
PORTLAND, OR 97216  
503-254-6600  
FAX 503-255-2615**







**When ordering spare parts, please specify tool type, part number and description.**

Note: Liner Casing Assembly = 152-911-9  
● Items in Pulse Repair Kit ALPHA-T140-PRK

AIMCO also offers a complete line of standard & special adapters, bits, sockets and extensions.

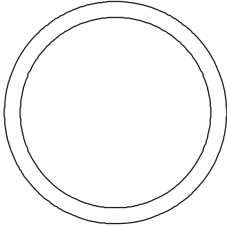

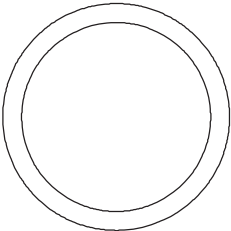
# ALPHA-T140-PRK

(Kit contains following parts)

#/#	Item Number on Exploded View	Part Number	QTY	Description	Material	Drawing / Scketch
1	<b>43</b>	944-003-0	1	Support Ring	Teflon-White	
2	<b>44</b>	944-205-0	1	Back Up Ring	Teflon-White	
3	<b>45</b>	944-225-0	1	Supporting Ring	Teflon-White	
4	<b>63</b>	976-795-0	2	Spring	Spring wire	
5	<b>66</b>	977-023-0	1	Cone Spring	Spring wire	
6	<b>77</b>	990-170-0	1	O-Ring	Buna-Black	
7	<b>78</b>	990-320-0	1	O-Ring	Buna-Black	

# ALPHA-T140-PRK

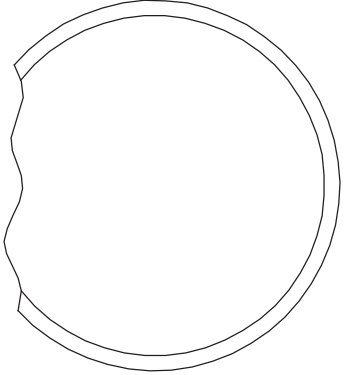
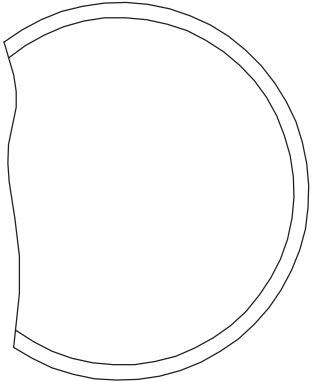
(Kit contains following parts)

#/#	Item Number on Exploded View	Part Number	QTY	Description	Material	Drawing / Scketch
8	<b>85</b>	990-936-0	1	O-Ring (SNS-45)	Buna-Black	
9	<b>86</b>	990-937-0	1	O-Ring (SNS-46)	Buna-Black	
10	<b>87</b>	990-971-0	2	O-Ring (SNS-3) (NOK)	Buna-Black	
11	<b>88</b>	990-972-0	1	O-Ring (SNS-4) (NOK)	Buna-Black	