

UL30 SERIES OIL-PULSE WRENCHES

EXPLODED VIEW

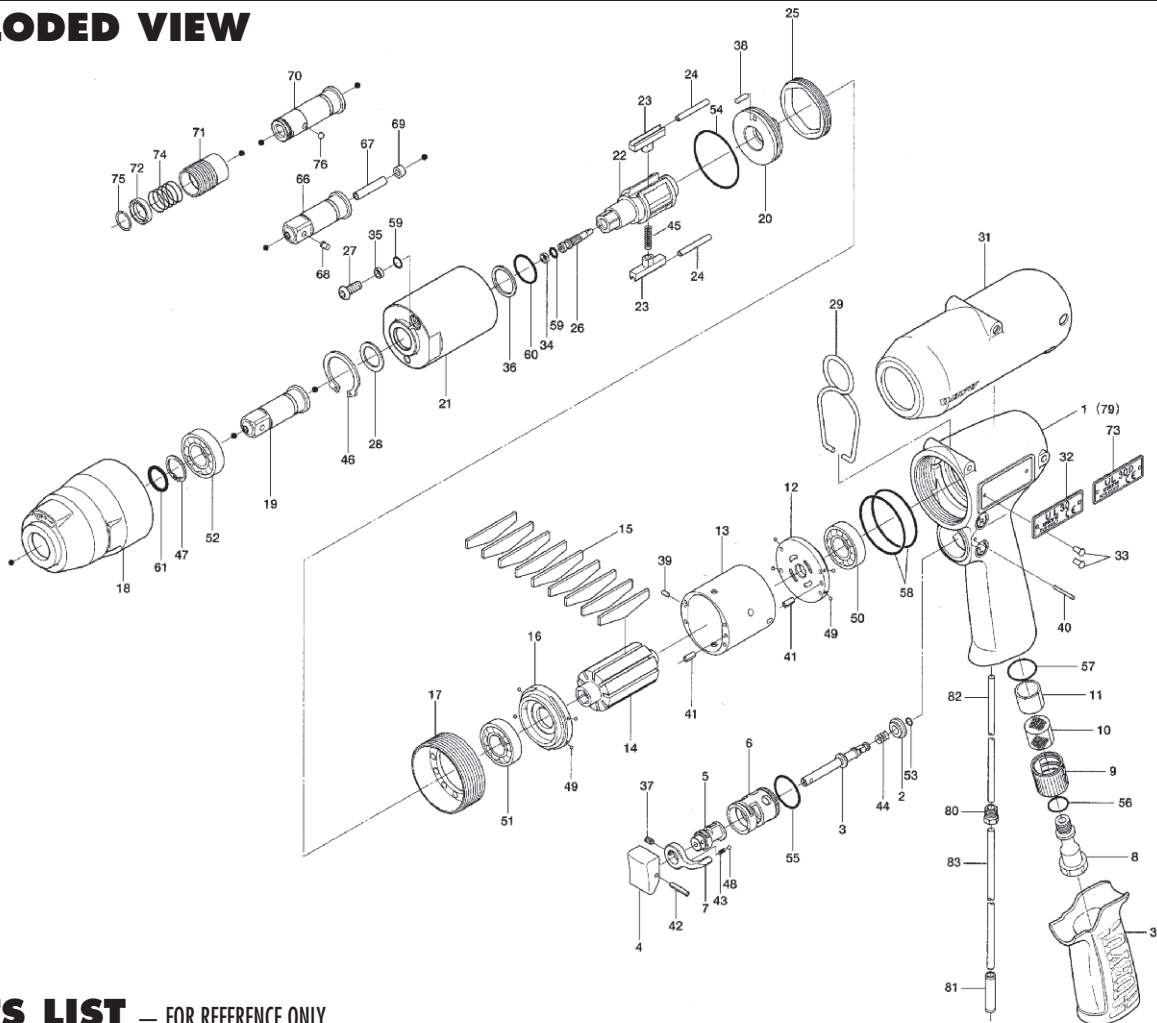

PARTS LIST — FOR REFERENCE ONLY

Index Number	Part Number	Description	Qty.	Index Number	Part Number	Description	Qty.	Index Number	Part Number	Description	Qty.
1	143-025-0	Handle	1	30	147-842-2	Handle Cover	1	59	990-970-0	O-Ring(SNS-2)NOK	2 ●
2	147-100-3	Valve	1	31	143-840-0	Casing Protector	1	60	992-019-0	SU-Ring(Q10)(NTN)	1 ●
3	147-104-2	Valve Rod	1	32	142-924-8	Name Plate	1	61	993-100-0	Rubber Sponge Ring(12X16.5X2)	1
4	147-107-2	Valve Lever	1	33	930-205-0	Driver Rivet No.(0X2.6)	2	66	891-565-1	Socket Spindle Assembly(P)	1
5	147-210-2	Reverse Valve	1	34	944-002-0	Supporting Ring(2.6X4.5X1)	1	67	891-559-1	Pipe	1
6	147-211-2	Reverse Valve Bushing	1	35	944-003-0	Supporting Ring(3X5X1)	1 ●	68	891-560-1	Socket Snap Pin	1
7	480-212-8	Reverse Lever	1	36	944-211-0	Supporting Ring(10X14X1.5)	1 ●	69	975-001-0	Spacer(6X2.8X3)	1
8	142-091-8	Air Inlet Bushing	1	37	952-106-0	Allen Head Dog Point Screw(M4X6)	1	PARTS FOR UL30D			
9	147-780-3	Exhaust Stack	1	38	970-148-0	Pin(H)(2.5X3.8)	1	70	143-350-2	Driver Anvil	1
10	147-042-2	Silencer	1	39	971-102-0	Pin (2X3.8)	1	71	011-351-1	Bit Sleeve(1/8)	1
11	145-835-8	Filter(K100)	1 ▲	40	971-123-0	Pin (2X23)	1	72	011-352-1	Bit Spacer	1
12	143-285-0	Rear Plate	1	41	973-008-0	Roll Pin (2X8)	2	73	142-924-9	Name Plate	1
13	143-286-0	Cylinder	1	42	973-014-0	Roll Pin(2X1.4)	1	74	976-327-0	Spring(13.5X11)(0.9)	1
14	143-287-0	Rotor	1	43	976-006-0	Spring(3X5)(0.4)	1	75	978-117-0	Snap Ring(11.7X1.0)	1
15	143-288-0	Blade(PC)	9 ▲	44	976-457-0	Spring(7X12)(0.9)	1	76	981-002-0	Ball(1/8)	1
16	144-289-0	Front Plate	1	45	976-803-0	Spring(2.8X18)(0.4)WPC	1 ●	PARTS FOR (TM)-TYPE			
17	143-036-0	Hammer Casing Connector	1	46	979-324-0	Inner Snap Ring(IRTW-24)	1	79	851-073-1	Handle	1
18	143-439-0	Front Casing	1	47	979-353-0	Inner Snap Ring(ISTW-12)	1	80	850-610-1	Connecting Screw	1
19	143-454-0	Socket Spindle	1	48	981-002-0	Ball(1/8)	1	81	933-250-0	One Touch Connector(SLS-04)	1
20	143-901-0	Liner Rear Plate	1	49	981-045-0	Ball(1.5)	8	82	935-240-0	Nylon Tube(18NY)	1
21	142-902-8	Liner	1	50	982-014-0	Ball Bearing(607)	1 ▲	83	935-350-0	Polyurethane Hose(F1504)	1
22	143-319-0	Anvil	1	51	982-901-0	Ball Bearing(6900)	1 ▲	Accessories			
23	143-440-0	Driving Blade	2	52	982-922-0	Ball Bearing(6901ZZ)	1	84	143-242-2	Adjuster	1
24	143-974-0	Roller(2.5X21)	2	53	990-306-0	O-Ring(ARP-568-004)(H)	1	85	939-091-0	Allen Wrench(1.5mm)(55X55)	1
25	143-906-0	Liner Casing Setter	1	54	990-329-0	O-Ring(JW1530-19)	1	FOOTNOTES			
26	143-970-3	Relief Valve	1	55	990-912-0	O-Ring(SNS-14)	1	●	Items in Pulse Repair Kit UL-30-PRK		
27	194-742-3	Oil Plug	1	56	990-914-0	O-Ring(SNS-16)	1	▲	Items in Pulse Repair Kit UL-30RK		
28	143-327-0	Anvil Front Spacer	1	57	990-916-0	O-Ring(SNS-18)	1				
29	143-790-3	Suspension Ring	1	58	990-925-0	O-Ring(SNS-32)	2 ▲				



10000 SE PINE ST,
PORTLAND, OR 97216
503-254-6600
FAX 503-255-2615







When ordering spare parts, please specify tool type, part number and description.

- Items in Pulse Repair Kit UL-30-PRK
- ▲ Items in Pulse Repair Kit UL-30RK

AIMCO also offers a complete line of standard & special adapters, bits, sockets and extensions.

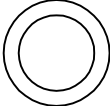

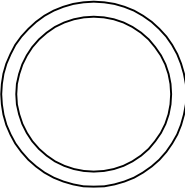
UL-30D-PRK

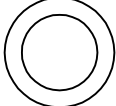
(Kit contains following parts)

#/#	Item Number on Exploded View	Part Number	QTY	Description	Material	Drawing / Scketch
1	34	944-002-0	1	Support Ring	Teflon-White	
2	35	944-003-0	1	Support Ring	Teflon-White	
3	36	944-211-0	1	Supporting Ring	Teflon-White	
4	45	976-803-0	1	Spring	Spring wire	
5	54	990-329-0	1	O-Ring	Buna-Black	
6	59	990-970-0	2	O-Ring	Buna-Black	
7	60	992-019-0	1	SU-Ring	Buna-Black	

UL-30D-RK

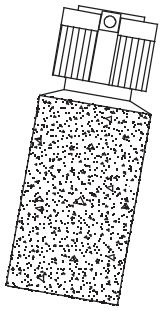
(Kit contains following parts)

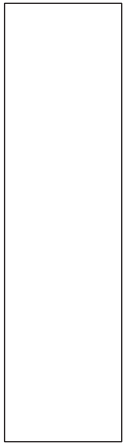
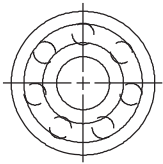
#/#	Item Number on Exploded View	Part Number	QTY	Description	Material	Drawing / Scketch
1	-	AM-OIL	1	Oil Air Motor 1 oz. fluid	Plastic Container	
2	15	143-288-0	9	Blade(PC)	Phenolic-Fiber	
3	11	145-835-8	1	Filter K100	Sendered Plastic	
4	50	982-014-0	1	Ball Bearing(607)	Bearing Steel	

UL-30D-RK

(Kit contains following parts)

#/#	Item Number on Exploded View	Part Number	QTY	Description	Material	Drawing / Scketch
5	51	982-901-0	1	Ball Bearing(6900)	Bearing Steel	
6	58	990-925-0	2	O-Ring (SNS-32)	Buna-Black	