

# UL-60(D) SERIES OIL-PULSE WRENCHES

## EXPLODED VIEW

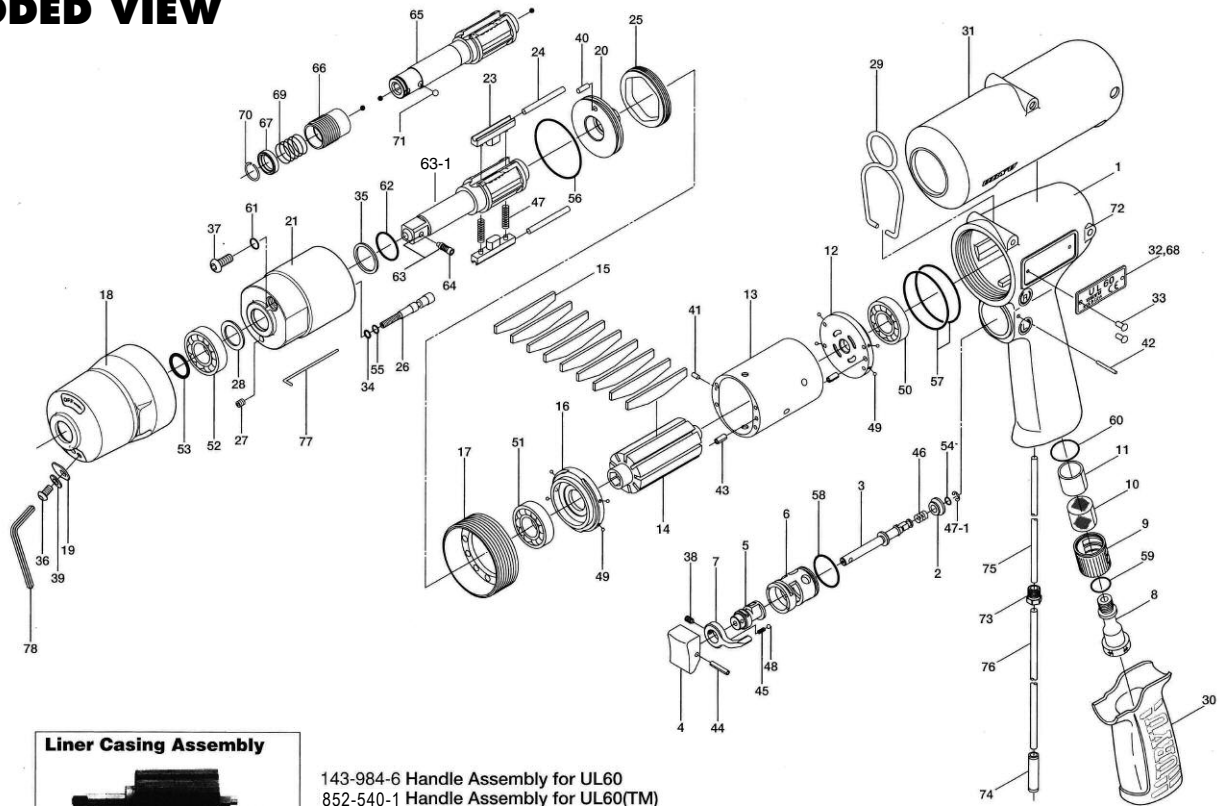

### Liner Casing Assembly



Code No. 891-474-1 for UL60  
Code No. 143-911-7 for UL60D

143-984-6 Handle Assembly for UL60  
852-540-1 Handle Assembly for UL60(TM)  
Components  
(#1 (for UL60) or #72 (for UL60 (TM)),  
#2, #3, #4, #5, #6, #7, #8, #38, #42,  
#44, #45, #46, #48, #54, #58

## PARTS LIST — FOR REFERENCE ONLY

Index Number	Part Number	Description	Qty.	Index Number	Part Number	Description	Qty.	Index Number	Part Number	Description	Qty.
1	143-025-7	Handle	1	35	944-212-0	Supporting Ring (12X16X1.5)	1 ●	63	891-561-1	Anvil (P)	1
2	147-100-3	Valve	1	36	945-935-0	Hexagon Round Head Bolt (M3X6)	1	63-1	143-319-6	Anvil (O)	1
3	147-104-2	Valve Rod	1	37	945-942-0	Hexagon Round Head Bolt (M4X6)	1	64	891-300-1	Socket Pin Assembly (3/8)	1
4	147-107-2	Valve Lever	1	38	952-106-0	Allen Head Dog Point Screw (M4X6)	1	<b>PARTS FOR UL60D</b>			
5	147-210-2	Reverse Valve	1	39	961-030-0	Flat Washer (3mm)	1	65	143-350-7	Driver Anvil	1
6	147-211-2	Reverse Valve Bushing	1	40	970-148-0	Pin (H) (2.5X3.8)	1	66	011-351-1	Bit Sleeve (1/8)	1
7	480-212-8	Reverse Lever	1	41	971-102-0	Pin (2X3.8)	1	67	011-352-1	Bit Spacer	1
8	147-091-2	Air Inlet Bushing	1	42	971-123-0	Pin (2X23)	1	68	143-924-7	Metal Tag	1
9	147-780-3	Exhaust Stack	1	43	973-008-0	Roll Pin (2X8)	2	69	976-327-0	Spring (13.5X11) (0.9)	1
10	147-042-2	Silencer	1	44	973-014-0	Roll Pin (2X14)	1	70	978-117-0	Snap Ring (11.7X1.0)	1
11	147-835-3	Filter (K200)	1 ▲	45	976-006-0	Spring (3X5)	1	71	981-002-0	Ball (1/8)	1
12	147-285-2	Rear Plate	1	46	976-457-0	Spring (7X12) (0.9)	1	<b>PARTS FOR (TM)-TYPE</b>			
13	147-286-2	Cylinder	1	47	976-788-0	Spring (3.5X25) (0.45) WPC	2 ●	72	852-524-1	Handle	1
14	147-287-3	Rotor	1	47-1	979-405-0	Outer Snap Ring (E2.5)	1	73	850-610-1	Connecting Screw	1
15	147-288-2	Blade (PC)	9 ▲	48	981-002-0	Ball (1/8)	1	74	933-250-0	One-touch Connector (SLS-04)	1
16	147-289-3	Front Plate	1	49	981-045-0	Ball (1.5)	8	75	935-240-0	Nylon Tube (13NY)	1
17	147-036-2	Hammer Casing Connector	1	50	982-014-0	Ball Bearing (607)	1 ▲	76	935-350-0	Polyurethane Hose (F-1504)	1
18	143-439-6	Front casing	1	51	982-902-0	Ball Bearing (6901)	1 ▲	<b>ACCESSORIES</b>			
19	143-243-8	Regulator Valve Cover	1	52	982-922-0	Ball Bearing (6901ZZ)	1	77	939-091-0	Allen Wrench (1.5)	1
20	143-901-6	Rear Liner Plate	1	53	993-100-0	Rubber Sponge Ring (12X16.5X2)	1	78	939-107-0	Allen Wrench (2)	1
21	143-902-6	Liner	1	54	990-306-0	O-Ring (ARP-568-004) (H)	1	● Items in Pulse Repair Kit UL-60(D)-PRK			
23	143-440-6	Driving Blade	2	55	990-320-0	O-Ring (ARP-568-003)	1 ●	▲ Items in Repair Kit UL-60(D)-RK			
24	143-974-6	Roller (2.5X25)	2	56	990-331-0	O-Ring (JW1530-21)	1 ●	AIMCO also offers a complete line of standard & special adapters, bits, sockets and extensions.			
25	143-906-3	Liner Casing Cover	1	57	990-337-0	O-Ring (JW1530-27)	2 ▲				
26	143-970-6	Relief Valve	1	58	990-912-0	O-Ring (SNS-14)	1				
27	136-969-7	Relief Valve Plate	1	59	990-914-0	O-Ring (SNS-16)	1				
28	178-327-9	Anvil Front Spacer	1	60	990-916-0	O-Ring (SNS-18)	1				
29	143-790-3	Suspension Ring	1	61	990-971-0	O-Ring (SNS-3) (NOK)	1 ●				
30	147-842-2	Handle Cover	1	62	992-020-0	SU-Ring (Q12) (NTN)	1 ●				
31	143-840-3	Handle Protector	1								
32	143-924-6	Metal Tag	1								
33	930-205-0	Driver Rivet No.0X2.6	2								
34	944-002-0	Supporting Ring (2.6X4.5X11)	1 ●								







10000 SE Pine Street  
Portland, OR 97216  
503-254-6600  
FAX 503-255-2615

When ordering spare parts, please specify tool type, part number and description.

- Items in Pulse Repair Kit UL-60(D)-PRK
- ▲ Items in Repair Kit UL-60(D)-RK

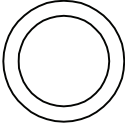

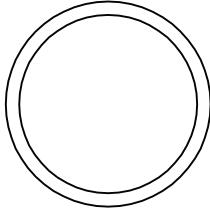
# UL-60D-PRK

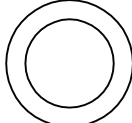
(Kit contains following parts)

#/#	Item Number on Exploded View	Part Number	QTY	Description	Material	Drawing / Scketch
1	34	944-002-0	1	Support Ring	Teflon-White	
2	35	944-212-0	1	Supporting Ring	Teflon-White	
3	47	976-788-0	2	Spring	Spring wire	
4	55	990-320-0	1	O-Ring	Buna-Black	
5	56	990-331-0	1	O-Ring	Buna-Black	
6	61	990-971-0	1	O-Ring	Buna-Black	
7	62	992-020-0	1	SU-Ring	Buna-Black	

# UL-60D-RK

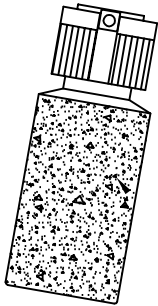
(Kit contains following parts)

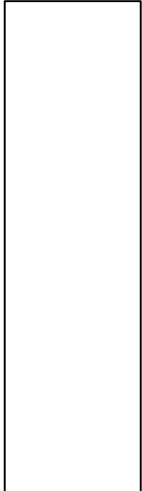
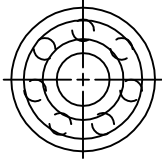
#/#	Item Number on Exploded View	Part Number	QTY	Description	Material	Drawing / Scketch
1	-	AM-OIL	1	Oil Air Motor 1 oz. fluid	Plastic Container	
2	15	147-288-2	9	Blade(PC)	Phenolic-Fiber	
3	11	147-835-3	1	Filter K100	Sendered Plastic	
4	50	982-014-0	1	Ball Bearing(607)	Bearing Steel	

# UL-60D-RK

(Kit contains following parts)

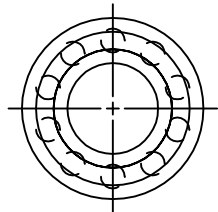
#/#	Item Number on Exploded View	Part Number	QTY	Description	Material	Drawing / Scketch
5	51	982-902-0	1	Ball Bearing	Bearing Steel	
6	57	990-337-0	2	O-Ring	Buna-Black	