

ULT-50(D) SERIES OIL-PULSE WRENCHES

EXPLODED VIEW

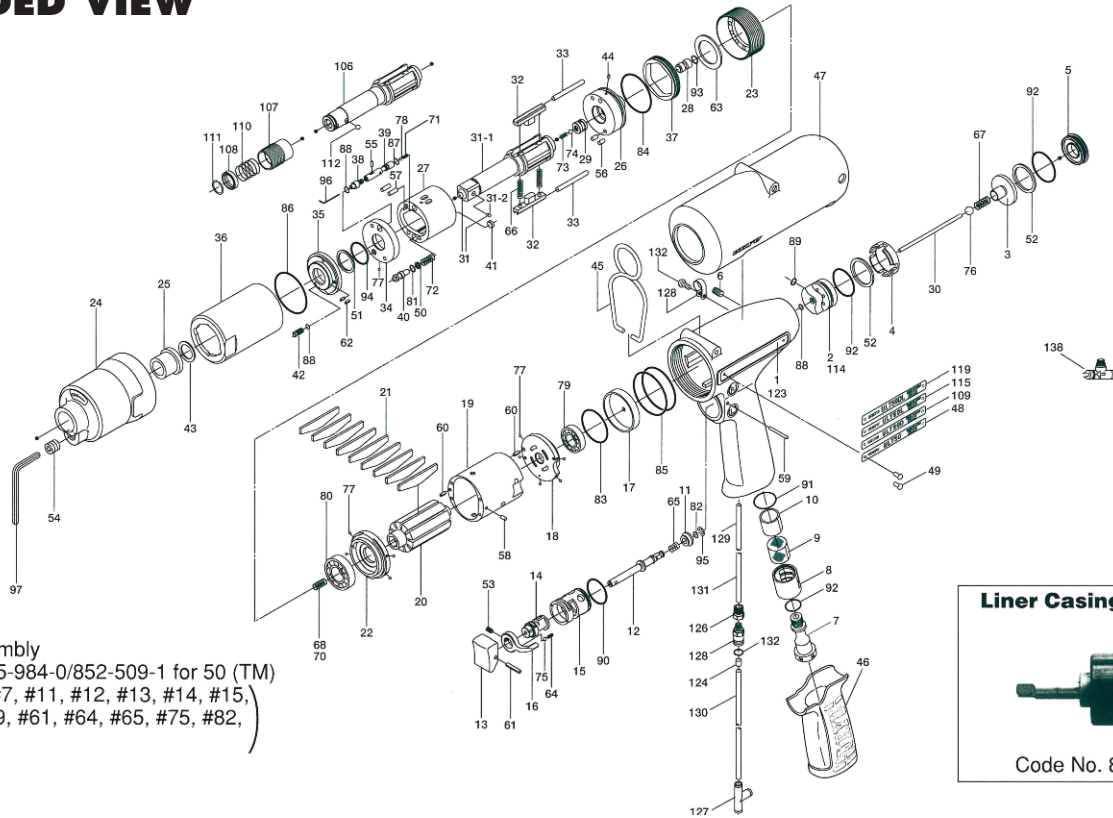

Handle Assembly
Code No. 145-984-0/852-509-1 for 50 (TM)
(#1 or #123, #7, #11, #12, #13, #14, #15,
#16, #53, #59, #61, #64, #65, #75, #82,
#90)



PARTS LIST — FOR REFERENCE ONLY

Index Number	Part Number	Description	Qty.	Index Number	Part Number	Description	Qty.	Index Number	Part Number	Description	Qty.
1	145-025-0	Handle	1	43	145-327-6	Anvil Front Spacer	1	88	990-900-0	O-Ring (SNS-2)	3 ●
2	145-253-0	Shut-off Valve Bushing	1	44	150-064-5	Plug	1	89	990-901-0	O-Ring (SNS-3)	1
3	145-254-6	Shut-off Valve	1	45	174-790-0	Suspension Ring	1	90	990-912-0	O-Ring (SNS-14)	1
4	145-684-6	Cushion Spacer	1	46	147-842-2	Handle Cover	1	91	990-914-0	O-Ring (SNS-16)	1
5	145-019-4	Valve Cover	1	47	145-840-7	Casing Cover	1	92	990-916-0	O-Ring (SNS-18)	3
6	150-108-5	Valve Plug	1	48	145-924-0	Name Plate (ULT-50)	1	93	990-305-0	O-Ring (ARPS68-003KS)	1 ●
7	147-091-2	Air Inlet Bushing	1	49	930-205-0	Pin (No. 0x2.6)	2	94	992-020-0	SU-Ring (Q12) NTN	1 ●
8	147-780-3	Exhaust Stack	1	50	944-002-0	Support Ring (2.6x4.5x1)	1	PARTS FOR ULT50D			
9	147-042-2	Silencer	1	51	944-212-0	Support Ring (1.2x1.6x1.5)	1	106	145-350-2	Driver Anvil	1
10	147-835-3	Filter (K200)	▲	52	944-217-0	Support Ring (1.4x2.0x1.8)	2	107	011-351-1	Bit Sleeve (1/8)	1
11	147-100-3	Valve	1	53	952-106-0	Allen Head Dog Point Screw (M4x6)	1	108	011-352-1	Bit Spacer	1
12	142-104-6	Valve Rod	1	54	966-099-0	Allen Head Plug (NPT1/16) GDL	1	109	145-924-2	Name Plate (ULT50D)	1
13	147-107-2	Valve Lever	1	55	970-013-0	Pin (H) (1.5x4)	1	110	976-327-0	Spring (13.5x11x0.9)	1
14	147-210-2	Reverse Valve	1	56	970-130-0	Pin (H) 12.45x4.5)	2	111	978-117-0	Snap Ring (11.7x1)	1
15	147-211-2	Reverse Valve Bushing	1	57	970-131-0	Pin (H) (2.45x9.5)	2	112	981-002-0	Ball (1/8)	1
16	480-212-8	Reverse Lever	1	58	971-102-0	Pin (2x2)	1	PARTS FOR ULT50L			
17	145-291-7	Rear Plate Spacer	1	59	971-123-0	Pin (2x2.3)	1	114	145-253-3	Shut-off Valve Bushing	1
18	145-285-6	Rear Plate	1	60	973-008-0	Roll Pin (2x8)	2	115	145-924-3	Name Plate	1
19	145-286-0	Cylinder	1	61	973-014-0	Roll Pin (2x1.4)	1	PARTS FOR ULT50DL			
20	145-287-0	Rotor	1	62	973-040-0	Roll Pin (1.5x5)	2	114	145-253-3	Shut-off Valve Bushing	1
21	145-288-0	Blade (PC)	▲	63	975-752-0	Adjusting Spacer (15x1 0xt)	1	119	145-924-4	Name Plate	1
22	145-289-4	Front Plate	1	64	976-006-0	Spring (3x5x0.4)	1	PARTS FOR TM-TYPE			
23	147-036-2	Hammer Casing Connector	1	65	976-457-0	Spring (7x12x0.9)	1	123	852-501-1	Handle	1
24	145-439-0	Front Casing	1	66	976-791-0	Spring (3.3x21 x0.4) WPC	2 ●	124	851-954-1	Medium Valve Sheet	1
25	190-328-6	Anvil Bushing	1	67	977-043-0	Cone Spring (4.1x4.7x9) (0.45)	1	126	851-955-1	Connecting Screw	1
26	145-901-0	Rear Liner Plate	1	68	976-650-0	Spring (3.3x1.8x0.45) [Standard]	1	127	909-442-0	Quick Exhaust (AQ240F-04-00)	1
27	145-902-0	Liner	1	70	976-662-0	Spring (3.3x1.8x0.45) Yellow [Strong]	1	128	933-281-0	One-Touch Connector (KJH04-M5)	1
28	145-546-6	Piston	1	71	976-632-0	Spring (2.8x7.7x0.4) for ULT50	1	129	935-240-0	Nylon Tube (18N1)	1
29	145-929-6	Check Valve Cover	1	72	976-674-0	Spring (4.3x1.4x0.55)	1	130	935-350-0	Polyurethane Hose (F-1504)	1
30	145-130-0	Operating Rod (2.1 x 50.9)	1	73	976-653-0	Spring (2.4x5x0.26)	1	131	935-358-0	Polyurethane Hose (TU-0212)	1
31	891-554-1	Anvil Assembly (P)	1	74	981-001-0	Ball (3/32)	1	132	990-903-0	O-Ring (SNS-5)	1
31-1	145-319-0	Anvil (O)	1	75	981-002-0	Ball (1/8)	1	ACCESSORIES			
31-2	891-300-1	Socket Pin Assembly	1	76	981-003-0	Ball (5/32)	1	96	939-091-0	Allen Wrench (1.5x80x20)	1
32	145-440-0	Driving Blade	2	77	981-045-0	Ball (1.5)	9	97	939-105-0	Allen Wrench (4)	1
33	145-974-0	Roller (2.5x21)	2	78	144-270-0	Pressure Control Valve	1	138	909-449-0	Speed Controller (AS1001F-04)	1
34	145-973-6	Liner Casing Spacer	1	79	982-014-0	Ball Bearing (607)	1	FOOTNOTES			
35	145-904-6	Front Liner Plate	1	80	982-902-0	Ball Bearing (6901)	1	●	Items in Pulse Repair Kit ULT-50(D)PRK		
36	145-905-0	Liner Casing	1	81	990-320-0	O-Ring (APR568-003)	1	▲	Items in Repair Kit ULT-50(D)-RK		
37	145-906-6	Liner Casing Cover	1	82	990-306-0	O-Ring (APR568-004H)	1				
38	145-907-6	Relief Valve Spindle	1	83	990-327-0	O-Ring (JW1530-18)	1				
39	144-970-0	Relief Valve	1	84	990-329-0	O-Ring (JW1530-19)	1				
40	145-972-6	Accumulator	1	85	990-337-0	O-Ring (JW1530-27)	2				
41	145-908-7	Accumulator Cover	1	86	990-605-0	O-Ring (25x1.45)	1				
42	194-742-0	Oil Plug	1	87	990-621-0	O-Ring (3.8x1.8x1.0)	1				



10000 SE PINE,
PORTLAND, OR 97216
503-254-6600
FAX 503-255-2615

When ordering spare parts, please specify tool type, part number and description.







FOOTNOTES

- Items in Pulse Repair Kit ULT-50(D)PRK
- ▲ Items in Repair Kit ULT-50(D)-RK

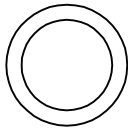
AIMCO also offers a complete line of standard & special adapters, bits, sockets and extensions.



ULT-50-PRK

(Kit contains following parts)

#/#	Item Number on Exploded View	Part Number	QTY	Description	Material	Drawing / Scketch
1	50	944-002-0	1	Support Ring	Teflon-White	
2	51	944-212-0	1	Supporting Ring	Teflon-White	
3	71	976-632-0	1	Spring	Spring wire	
4	73	976-653-0	1	Spring	Spring wire	
5	72	976-674-0	1	Spring	Spring wire	
6	-	976-682-0	1	Spring	Spring wire	
7	66	976-791-0	2	Spring	Spring wire	
8	93	990-305-0	1	O-Ring	Buna-Black	
9	81	990-320-0	1	O-Ring	Buna-Black	

ULT-50-PRK

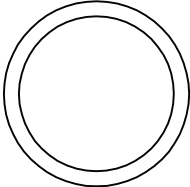
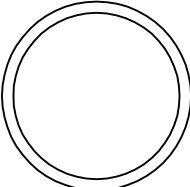
(Kit contains following parts)

#/#	Item Number on Exploded View	Part Number	QTY	Description	Material	Drawing / Scketch
10	84	990-329-0	1	O-Ring	Buna-Black	
11	86	990-605-0	1	O-Ring	Buna-Black	
12	87	990-621-0	1	O-Ring	Buna-Black	
13	88	990-900-0	2	O-Ring	Buna-Black	
14	94	992-020-0	1	SU-Ring	Buna-Black	