

UX-1000 OIL-PULSE TOOLS

EXPLODED VIEW

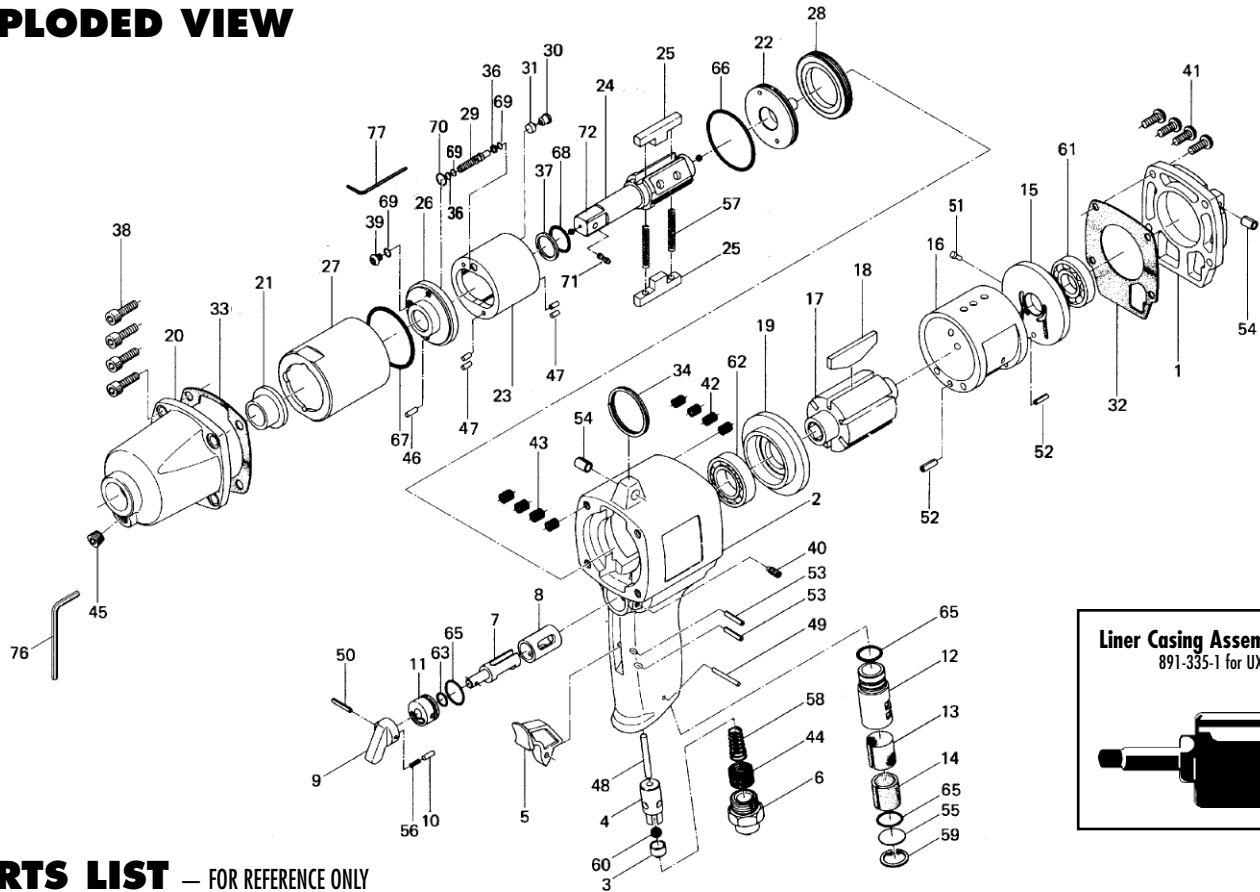

PARTS LIST — FOR REFERENCE ONLY

Index Number	Part Number	Description	Qty.	Index Number	Part Number	Description	Qty.	Index Number	Part Number	Description	Qty.
1	194-012-4	Head cover	1	28	194-906-4	Liner Casing Cover	1	56	976-025-0	Spring (3 x 8.5)	1
2	194-025-4	Handle	1	29	194-907-4	Relief Valve Spindle	1	57	976-453-0	Spring (4.5 x 34.5)	2 ●
3	188-100-1	Valve	1	30	194-969-4	Relief Valve Plug	1	58	977-175-0	Cone Spring (7.5 x 10.3 x 22)	1
4	063-102-3	Valve Bushing	1	31	195-970-3	Relief Valve	1	59	979-318-0	Inner Snap Ring (IRTW-18)	1
5	026-107-7	Valve Lever	1	32	194-853-4	Head Cover Packing	1 ▲■	60	981-208-0	Ball (5/16) Black	1
6	185-091-7	Air Inlet Bushing	1	33	194-867-4	Front Casing Packing	1 ▲	61	982-403-0	Ball Bearing (EE-4)	1 ▲
7	199-210-1	Reverse Valve	1	34	004-790-2	Suspension Ring	1	62	982-951-0	Ball Bearing (16003)	1 ▲
8	199-211-1	Reverse Valve Bushing	1	36	944-003-0	Supporter Ring (3 x 5 x 1)	2 ●	63	990-205-0	O-Ring (JW1516-5)	1
9	023-212-4	Reverse Lever	1	37	944-210-0	Supporter Ring (16 x 19.9 x 1)	1 ●	65	990-914-0	O-Ring (SNS-16)	3
10	054-220-1	Reverse Lever Notch	1	38	945-216-0	Allen Head Bolt (M6 x 16)	4	66	990-930-0	O-Ring (SNS-40)	1 ●
11	187-222-1	Reverse Lever Setter	1	39	945-942-0	Hexagon Round Head Bolt (M4 x 6)	1	67	990-932-0	O-Ring (SNS-42)	1 ●
12	194-780-4	Exhaust Stack	1	40	952-108-0	Allen Head Dog Point Screw (M4 x 8)	1	68	992-021-0	O-Ring (Q-16) (NTN)	1 ●
13	194-042-4	Silencer	1	41	945-954-0	Hexagon Round Head Bolt (M5 x 16)	4	69	990-971-0	O-Ring (SNS-3) (NOK)	3 ●
14	194-835-5	Filter (K50)	1 ▲■	42	965-011-0	Heli-Sert (M5 x 1.5D)	4	70	990-974-0	O-Ring (SNS-6) (NOK)	1 ●
15	041-285-7	Rear Plate	1	43	965-021-0	Heli-Sert (M6 x 1.5D)	4	71	891-304-1	Socket Retainer Pin Assembly	1
16	188-286-9	Cylinder	1	44	965-073-0	Heli-Sert (UNF5/8) (N6)	1	72	194-319-4	Anvil (OP-0)	1
17	194-287-4	Rotor	1	45	966-100-0	Allen Head Plug (1/8)	1				
18	175-288-9	Rotor Blade (PC)	6 ▲■	46	969-450-0	Pin (G) (3 x 8)	1				
19	194-289-4	Front Plate	1	47	970-206-0	Pin (H) (3 x 8)	4				
20	194-439-4	Front Casing	1	48	970-337-0	Pin (H) (4 x 36)	1				
21	189-328-8	Anvil Bushing	1	49	971-163-0	Pin (2.5 x 23)	1				
22	194-901-4	Rear Liner Plate	1	50	973-016-0	Roll Pin (2 x 16)	1				
23	194-902-4	Liner	1	51	980-008-0	Round Head Notch (2.4)	1				
24	891-312-1	Anvil (OP-P)	1	52	973-108-0	Roll Pin (3 x 8)	2				
25	194-440-4	Driving Blade	2	53	973-116-0	Roll Pin (3 x 16)	2				
26	194-904-4	Front Liner Plate	1	54	973-340-0	Roll Pin (6 x 10)	2				
27	194-905-4	Liner Casing	1	55	975-598-0	Round Plate (18 x 1)	1				

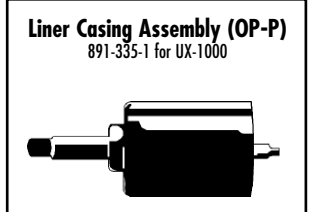

ACCESSORIES

76	939-104-0	Allen Wrench (5mm)	1
77	939-109-0	Allen Wrench (2mm) (64 x 64)	1

FOOTNOTES

- Items in Pulse Repair Kit UX-1000-PRK
- ▲ Items in Repair Kit UX-1000-RK
- Items in Repair Kit Oil Free UX-1000-RKOF

AIMCO also offers a complete line of standard & special adapters, bits, sockets and extensions.





10000 SE PINE,
PORTLAND, OR 97216
503-254-6600
FAX 503-255-2615

When ordering spare parts, please specify tool type, part number and description.

UX-1000-PRK

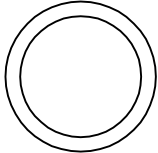
(Kit contains following parts)

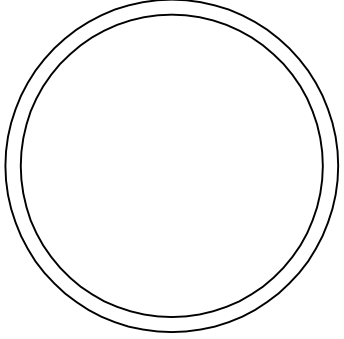
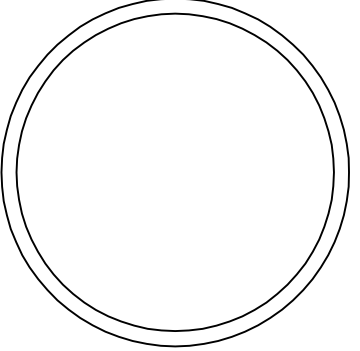
#/#	Item Number on Exploded View	Part Number	QTY	Description	Material	Drawing / Scketch
1	36	944-003-0	2	Support Ring	Teflon-White	
2	37	944-210-0	1	Support Ring	Teflon-White	
3	57	976-453-0	2	Spring	Spring wire	
4	66	990-930-0	1	O-Ring (SNS-40)	Buna-Black	
5	67	990-932-0	1	O-Ring (SNS-42)	Buna-Black	

UX-1000-PRK

(Kit contains following parts)

#/#	Item Number on Exploded View	Part Number	QTY	Description	Material	Drawing / Scketch
6	69	990-971-0	3	O-Ring	Buna-Black	
7	70	990-974-0	1	O-Ring	Buna-Black	
8	68	992-021-0	1	SU-Ring	Buna-Black	

UX-1000-RK

(Kit contains following parts)

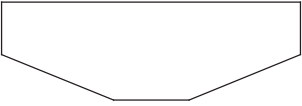
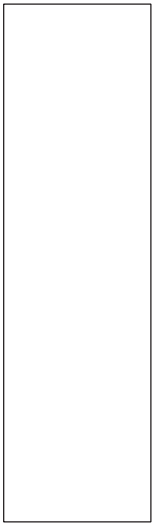
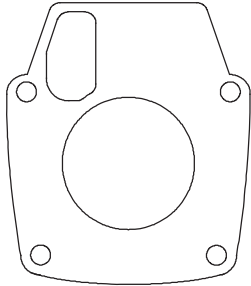
#/#	Item Number on Exploded View	Part Number	QTY	Description	Material	Drawing / Scketch
1	18	175-288-9	6	Blade(Coated)	Phenolic-Fiber	
2	14	194-835-5	1	Filter	Sendeder Plastic	
3	32	194-853-4	1	Rear Packing	Robberized Metal	 <p style="text-align: center;">Scale 1:2</p>

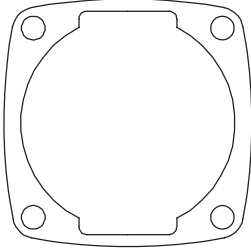
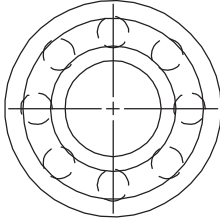
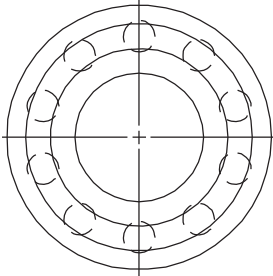
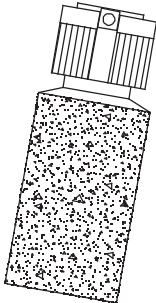

UX-1000-RK

(Kit contains following parts)

#/#	Item Number on Exploded View	Part Number	QTY	Description	Material	Drawing / Scketch
4	33	194-867-4	1	Front Packing	Gasket Material	 <p style="text-align: center;">Scale 1:2</p>
5	61	982-403-0	1	Ball Bearing(EE-4)	Bearing Steel	
6	62	982-951-0	1	Ball Bearing(16003)	Bearing Steel	
7	-	AM-OIL	1	Oil Air Motor 1 oz. fluid	Plastic Container	 <p style="text-align: right;">Scale 1:2</p>

UX-1000-RKOF

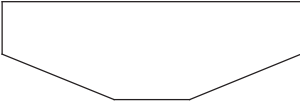
(Kit contains following parts)

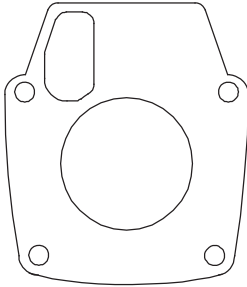
#/#	Item Number on Exploded View	Part Number	QTY	Description	Material	Drawing / Scketch
1	18	175-288-9	6	Blade(Coated)	Phenolic-Fiber	
2	14	194-835-5	1	Filter	Sendeder Plastic	
3	32	194-853-4	1	Rear Packing	Robberized Metal	 <p style="text-align: center;">Scale 1:2</p>