

UX-1300 OIL-PULSE TOOLS

EXPLODED VIEW

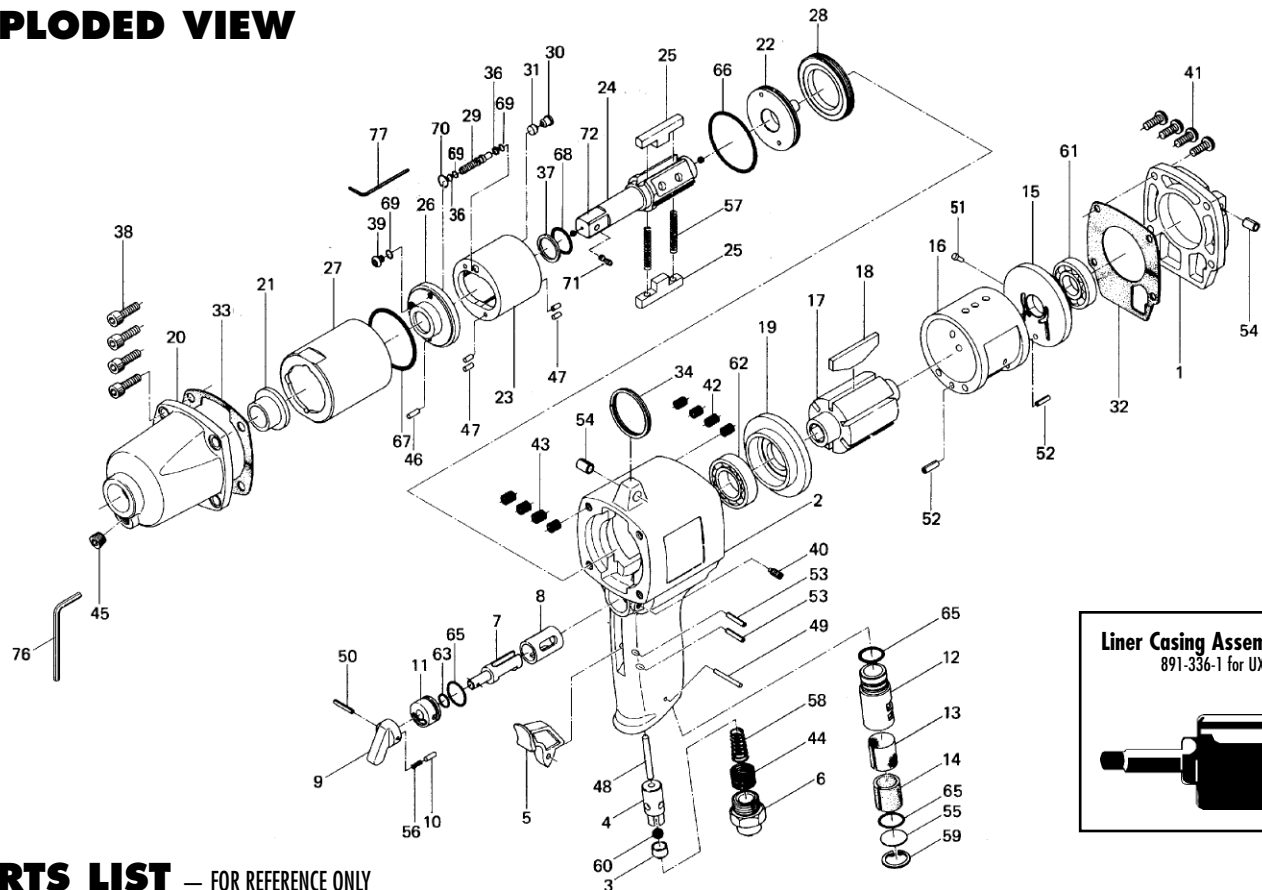

PARTS LIST — FOR REFERENCE ONLY

Index Number	Part Number	Description	Qty.	Index Number	Part Number	Description	Qty.	Index Number	Part Number	Description	Qty.
1	194-012-6	Head Cover	1	28	194-906-4	Liner Casing Cover	1	56	976-025-0	Spring (3 x 8.5)	1
2	194-025-6	Handle	1	29	195-907-3	Relief Valve Spindle	1	57	976-453-0	Spring (4.5 x 34.5)	2 ●
3	188-100-1	Valve	1	30	194-969-4	Relief Valve Plug	1	58	977-175-0	Cone Spring (7.5 x 10.3 x 22)	1
4	063-102-3	Valve Bushing	1	31	163-970-3	Relief Valve	1	59	979-318-0	Inner Snap Ring (IRTW-18)	1
5	026-107-7	Valve Lever	1	32	166-853-4	Head Cover Packing	1	60	981-208-0	Ball (5/16) Black	1
6	185-091-7	Air Inlet Bushing	1	33	194-867-6	Front Casing Packing	1	61	982-404-0	Ball Bearing (EE-5)	1
7	199-210-1	Reverse Valve	1	34	004-790-2	Suspension Ring	1	62	982-905-0	Ball Bearing (6904)	1
8	199-211-1	Reverse Valve Bushing	1	36	944-003-0	Back-up Ring (3 x 5 x 1)	2 ●	63	990-205-0	O-Ring (JW1516-5)	1
9	023-212-4	Reverse Lever	1	37	944-210-0	Supporter Ring (16 x 19.9 x 1)	1 ●	65	990-914-0	O-Ring (SNS-16)	3
10	054-220-1	Reverse Lever Notch	1	38	945-216-0	Allen Head Bolt (M6 x 16)	4	66	990-930-0	O-Ring (SNS-40)	1 ●
11	187-222-1	Reverse Lever Setter	1	39	945-942-0	Hexagon Round Head Bolt (M4 x 6)	1	67	990-932-0	O-Ring (SNS-42)	1 ●
12	194-780-4	Exhaust Stack	1	40	952-108-0	Allen Head Dog Point Screw (M4 x 8)	1	68	992-021-0	O-Ring (Q-19) (NTN)	1 ●
13	194-042-4	Silencer	1	41	945-954-0	Hexagon Round Head Bolt (M5 x 16)	4	69	990-971-0	O-Ring	3 ●
14	194-835-7	Filter(K50)	1	42	965-011-0	Heli-Sert (M5 x 1.5D)	4	70	990-974-0	O-Ring (SNS-6) (NOK)	1 ●
15	194-285-6	Rear Plate	1	43	965-021-0	Heli-Sert (M6 x 1.5D)	4	71	891-304-1	Socket Retainer Pin Assembly	1
16	063-286-7	Cylinder	1	44	965-073-0	Heli-Sert (UNFS/8) (N6)	1	72	194-319-7	Anvil (OP-0)	1
17	194-287-6	Rotor	1	45	966-100-0	Allen Head Plug (1/8)	1	73	970-093-0	Pin	1
18	194-288-6	Blade	6	46	969-450-0	Pin (G) (3 x 8)	1				
19	194-289-6	Front Plate	1	47	970-206-0	Pin (H) (3 x 8)	4				
20	194-439-6	Front Casing	1	48	970-337-0	Pin (H) (4 x 36)	1				
21	189-328-8	Anvil Bushing	1	49	971-163-0	Pin (2.5 x 23)	1				
22	194-901-6	Rear Liner Plate	1	50	973-016-0	Roll Pin (2 x 16)	1				
23	166-902-3	Liner	1	51	973-066-0	Roll Pin (2.5 x 6)	1				
24	891-313-1	Anvil (OP-P)	1	52	973-212-0	Roll Pin (4 x 12)	2				
25	194-440-7	Driving Blade	2	53	973-116-0	Roll Pin (3 x 16)	2				
26	175-904-7	Front Liner Plate	1	54	973-340-0	Roll Pin (6 x 10)	2				
27	194-905-6	Liner Casing	1	55	975-598-0	Round Plate (18 x 1)	1				

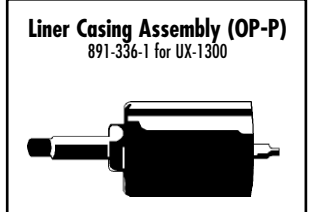

ACCESSORIES

76	939-104-0	Allen Wrench (5mm)	1
77	939-109-0	Allen Wrench (2mm) (64 x 64)	1

FOOTNOTES

- Items in Pulse Repair Kit UX-1300-PRK

AIMCO also offers a complete line of standard & special adapters, bits, sockets and extensions.





10000 SE PINE,
PORTLAND, OR 97216
503-254-6600
FAX 503-255-2615

When ordering spare parts, please specify tool type, part number and description.

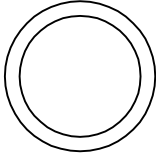

UX-1300-PRK

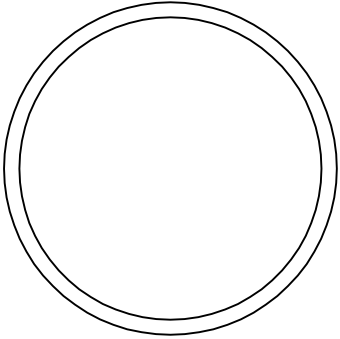
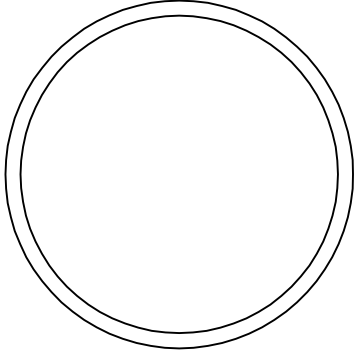
(Kit contains following parts)

#/#	Item Number on Exploded View	Part Number	QTY	Description	Material	Drawing / Scketch
1	36	944-003-0	2	Support Ring	Teflon-White	
2	37	944-210-0	1	Support Ring	Teflon-White	
3	57	976-453-0	2	Spring	Spring wire ø.60 mm	
4	66	990-930-0	1	O-Ring (SNS-40)	Buna-Black	
5	67	990-932-0	1	O-Ring (SNS-42)	Buna-Black	

UX-1300-PRK

(Kit contains following parts)

#/#	Item Number on Exploded View	Part Number	QTY	Description	Material	Drawing / Scketch
6	69	990-971-0	3	O-Ring (SNS-3) (NOK)	Buna-Black	
7	70	990-974-0	1	O-Ring (SNS-6) (NOK)	Buna-Black	
8	68	992-021-0	1	SU-Ring (Q-19) (NTN)	Buna-Black	