

UX-612, 612D OIL-PULSE TOOLS

EXPLODED VIEW

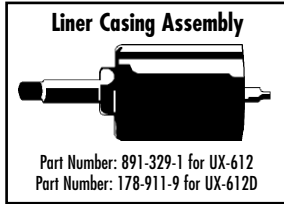
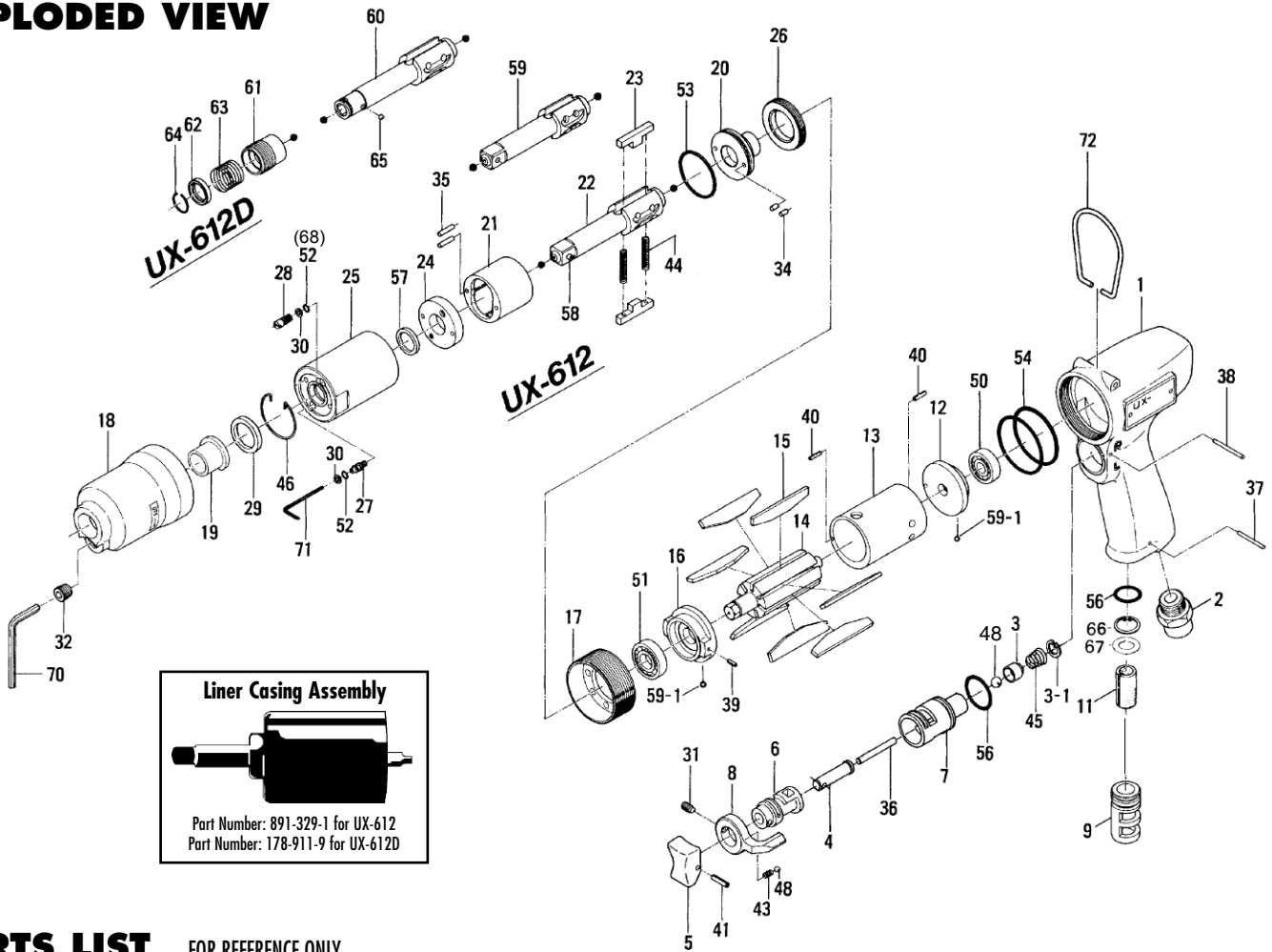

PARTS LIST — FOR REFERENCE ONLY

Index Number	Part Number	Description	Qty.	Index Number	Part Number	Description	Qty.	Index Number	Part Number	Description	Qty.
1	178-025-8	Casing	1	26	190-906-6	Liner Casing Setter	1	56	990-912-0	O-Ring (SNS-14)	2
2	480-091-8	Air Inlet Bushing	1	27	174-907-8	Relief Valve Spindle	1	57	995-512-0	Teflon Seal (P12)	1 ●
3	850-366-1	Valve Cover	1	28	178-742-0	Oil Plug	1	58	891-300-1	Socket Pin Assembly (3/8)	1
3-1	850-365-1	Valve	1	29	178-327-9	Anvil Front Spacer	1	59	178-319-8	Anvil (OP-0)	1
4	427-103-5	Valve Rod Bushing	1	30	944-002-0	Supporting Ring (2.6 x 4.5 x 1)	2 ●	59-1	981-045-0	Ball (1.5)	2
5	177-107-5	Valve Lever	1	31	952-106-0	Allen Head Dog Point Screw (M4 x 6)	1	60	178-350-0	Driver Anvil	1 ■
6	480-210-9	Reverse Valve	1	32	966-099-0	Allen Head Plug (NPT1/16) GDL	1	61	011-351-1	Bit Sleeve	1 ■
7	850-382-1	Reverse Valve Bushing	1	34	970-130-0	Pin (H) (2.45 x 4.5)	2	62	011-352-1	Bit Spacer	1 ■
8	480-212-8	Reverse Lever	1	35	970-135-0	Pin (H) (2.45 x 11)	2	63	976-327-0	Spring (13.5 x 11)	1 ■
9	480-780-8	Exhaust Stack	1	36	969-412-0	Pin (G) (2 x 12)	1	64	978-117-0	Snap Ring (11.7 x 1.0)	1 ■
11	177-835-6	Filter	1 ▲	37	971-120-0	Pin (2 x 20)	1	65	981-002-0	Ball (1/8)	1 ■
12	182-285-2	Rear Plate	1	38	971-123-0	Pin (2 x 23)	1	66	979-004-0	Inner Snap Ring (11)	1
13	178-286-8	Cylinder	1	39	973-006-0	Roll Pin (2 x 6)	1	67	996-405-0	Polyurethane Packing (11.5 x 6 x 2)	1
14	196-287-4	Rotor	1	40	973-008-0	Roll Pin (2 x 8)	2	68	990-900-0	O-Ring, When Used	1 ●
15	150-288-9	Rotor Blade (PC)	7 ▲	41	973-014-0	Roll Pin (2 x 14)	1				
16	182-289-2	Front Plate	1	43	976-006-0	Spring (3 x 5)	1				
17	177-036-5	Hammer Casing Connector	1	44	976-792-0	Spring (3.5 x 21) (0.45) WPC	2 ●				
18	178-439-8	Front Casing	1	45	976-229-0	Spring (3.2 x 13)	1				
19	190-328-6	Anvil Bushing	1	46	978-282-0	Snap Ring (28 x 1.0)	1				
20	196-901-4	Rear Liner Plate	1	48	981-002-0	Ball (1/8)	2				
21	190-902-6	Liner	1	50	982-401-0	Ball Bearing (EE-2)	1 ▲				
22	891-316-1	Anvil (OP-P)	1	51	982-402-0	Ball Bearing (EE-3)	1 ▲				
23	190-440-6	Driving Blade	2	52	990-320-0	O-Ring (ARP568-003)	2 ●				
24	178-904-8	Liner Front Plate	1	53	990-329-0	O-Ring (JW1530-19)	1 ●				
25	178-905-9	Liner Casing	1	54	990-337-0	O-Ring (JW1530-27)	2 ▲				

ACCESSORIES

70	939-105-0	Allen Wrench (4mm)	1
71	939-091-0	Allen Wrench (1.5mm)	1
72	010-790-1	Suspension Ring	1

AIMCO also offers a complete line of standard & special adapters, bits, sockets and extensions.

FOOTNOTES

- = Parts for UX-612D
- Items in Pulse Repair Kit UX-612(D)-PRK
- ▲ Items in Pulse Repair Kit UX-612(D)-RK







10000 SE PINE,
PORTLAND, OR 97216
503-254-6600
FAX 503-255-2615

When ordering spare parts, please specify tool type, part number and description.

UX-612-PRK

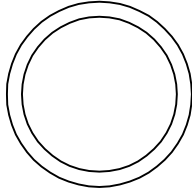
(Kit contains following parts)

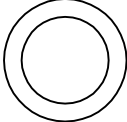
#/#	Item Number on Exploded View	Part Number	QTY	Description	Material	Drawing / Scketch
1	30	944-002-0	2	Support Ring	Teflon-White	
2	44	976-792-0	2	Spring 3.5x21	Spring wire	
3	52	990-320-0	2	O-Ring	Buna-Black	
4	53	990-329-0	1	O-Ring	Buna-Black	
5	68	990-900-0	1	O-Ring	Buna-Black	
6	57	995-512-0	1	Teflon Seal (P12)	Teflon-Black	

UX-612-RKOF

(Kit contains following parts)

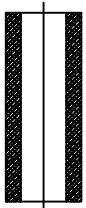
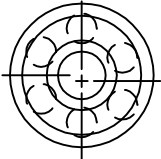
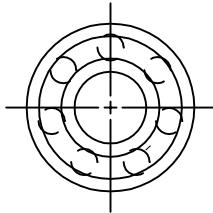
#/#	Item Number on Exploded View	Part Number	QTY	Description	Material	Drawing / Scketch
1	15	150-288-9	7	Blade	Phenolic-Fiber	
2	11	177-835-6	1	Filter	Filter Element (Yellow)	
3	50	982-401-0	1	Ball Bearing	Bearing Steel	
4	51	982-402-0	1	Ball Bearing	Bearing Steel	
5	54	990-337-0	2	O-Ring	Buna-Black	