

UX-900 OIL-PULSE TOOLS

EXPLODED VIEW

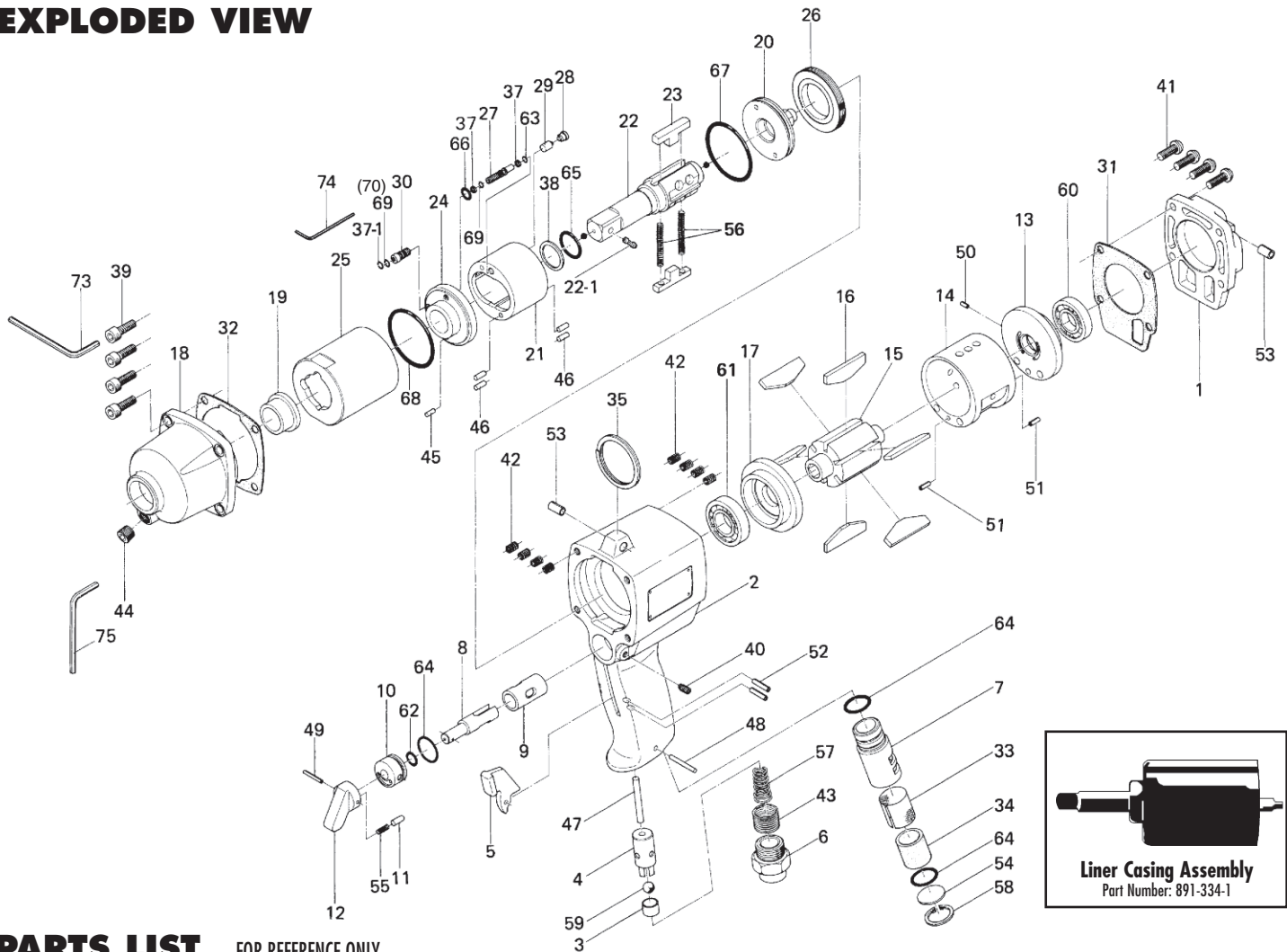

PARTS LIST — FOR REFERENCE ONLY

Index Number	Part Number	Description	Qty.	Index Number	Part Number	Description	Qty.	Index Number	Part Number	Description	Qty.
1	194-012-3	Head Cover	1	27	194-907-3	Relief Valve Spindle	1	54	975-598-0	Round Plate (18 x 1)	1
2	194-025-3	Handle	1	28	194-969-2	Relief Valve Plug	1	55	976-025-0	Spring (3 x 8.5)	1
3	188-100-1	Valve	1	29	194-970-2	Relief Valve	1	56	976-794-0	Spring (3.8 x 33 x 0.5) WPC	2
4	063-102-3	Valve Bushing	1	30	194-742-3	Oil Plug	1	57	977-175-0	Cone Spring (7.5 x 10.3 x 22)	1
5	187-107-1	Valve Lever	1	31	194-853-3	Head Cover Pecking	1	58	979-011-0	Inner Snap Ring (18)	1
6	185-091-7	Air Inlet Bushing	1	32	194-867-3	Front Casing Packing	1	59	981-208-0	Ball (5/16)	1
7	194-780-4	Exhaust Stack	1	33	194-042-4	Silencer	1	60	982-403-0	Ball Bearing (EE-4)	1
8	187-210-1	Reverse Valve	1	34	194-835-4	Filter	1	61	982-950-0	Ball Bearing (16002)	1
9	185-211-1	Reverse Valve Bushing	1	35	004-790-2	Suspension Ring	1	62	990-205-0	O-Ring (JW1516-5)	1
10	187-222-1	Reverse Valve Setter	1	37	944-002-0	Supporter Ring (2.6 x 4.5 x 1)	2	63	990-320-0	O-Ring (ARP568-003)	1
11	054-220-1	Reverse Lever Notch	1	37-1	944-003-0	Supporter Ring (3 x 5 x 1)	1	64	990-914-0	O-Ring (SNS-16)	3
12	023-212-4	Reverse Lever	1	38	944-210-0	Supporter Ring (16 x 19.9 x 1)	1	65	992-021-0	O-Ring (Q-16) (NTN)	1
13	194-285-3	Rear Plate	1	39	945-117-0	Allen Head Bolt (M5 x 16)	4	66	990-973-0	O-Ring (SNS-5) (NOK)	1
14	194-286-3	Cylinder	1	40	952-108-0	Allen Head Dog Point Screw (M4 x 8)	1	67	990-607-0	O-Ring (34 x 2.3)	1
15	194-287-3	Rotor	1	41	945-954-0	Hexagon Round Head Bolt (M5 x 16)	4	68	990-338-0	O-Ring (JW1530-28)	1
16	168-288-6	Blade (PC)	6	42	965-011-0	Heli-Sert (M5 x 1.5D)	8	69	990-900-0	O-Ring (SNS-2)	2
17	194-289-3	Front Plate	1	43	965-073-0	Heli-Sert (UNF5/8 x N6)	1	70	990-971-0	O-Ring, When Used	1
18	194-439-3	Front Casing	1	44	966-100-0	Allen Head Plug (PT1/8)	1				
19	188-328-2	Anvil Bushing	1	45	969-450-0	Pin (G) (3 x 8)	1				
20	194-901-3	Rear Liner Plate	1	46	970-206-0	Pin (H) (3 x 8)	4				
21	194-902-3	Liner	1	47	970-337-0	Pin (H) (4 x 36)	1				
22	891-311-1	Anvil (OP-P)	1	48	971-163-0	Pin (2.5 x 23)	1				
22-1	891-304-1	Socket Retainer Pin Assembly	1	49	973-016-0	Roll Pin (2 x 16)	1				
23	194-440-3	Driving Blade	2	50	973-066-0	Roll Pin (2.5 x 6)	1				
24	194-904-3	Front Liner Plate	1	51	973-108-0	Roll Pin (3 x 8)	2				
25	194-905-3	Liner Casing	1	52	973-114-0	Roll Pin (3 x 14)	2				
26	194-906-3	Liner Casing Setter	1	53	973-340-0	Roll Pin (6 x 10)	2				



ACCESSORIES

73	939-105-0	Allen Wrench (4mm)	1
74	939-109-0	Allen Wrench (2mm) (64 x 64)	1
75	939-104-0	Allen Wrench (5mm)	1

FOOTNOTES

- Items in Pulse Repair Kit UX-900-PRK
- ▲ Items in Pulse Repair Kit UX-900-RK

AIMCO also offers a complete line of standard & special adapters, bits, sockets and extensions.







10000 SE PINE,
PORTLAND, OR 97216
503-254-6600
FAX 503-255-2615

When ordering spare parts, please specify tool type, part number and description.



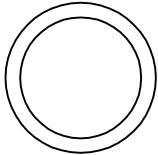

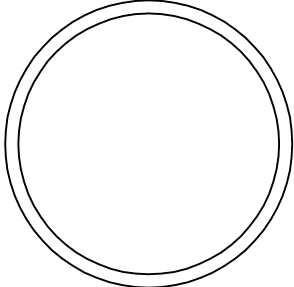
UX-900-PRK

(Kit contains following parts)

#/#	Item Number on Exploded View	Part Number	QTY	Description	Material	Drawing / Scketch
1	37	944-002-0	2	Support Ring	Teflon-White	
2	37-1	944-003-0	1	Support Ring	Teflon-White	
3	38	944-210-0	1	Support Ring	Teflon-White	
4	56	976-794-0	2	Spring	Spring wire	
5	63	990-320-0	1	O-Ring	Buna-Black	
6	68	990-338-0	1	O-Ring	Buna-Black	

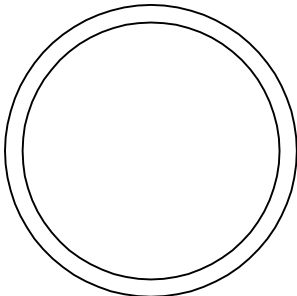
UX-900-PRK

(Kit contains following parts)

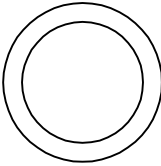
#/#	Item Number on Exploded View	Part Number	QTY	Description	Material	Drawing / Scketch
7	67	990-607-0	1	O-Ring	Buna-Black	
8	69	990-900-0	2	O-Ring	Buna-Black	
9	70	990-971-0	1	O-Ring	Buna-Black	
10	66	990-973-0	1	O-Ring	Buna-Black	
11	65	992-021-0	1	SU-Ring	Buna-Black	

UX-900-RK

(Kit contains following parts)

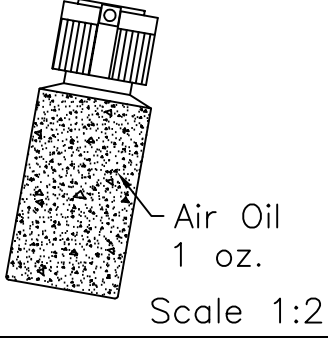
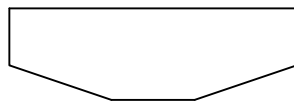
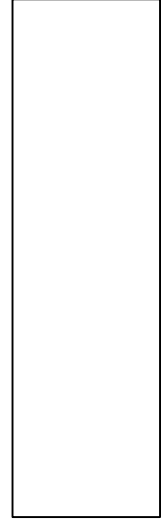
#/#	Item Number on Exploded View	Part Number	QTY	Description	Material	Drawing / Scketch
1	-	AM-OIL	1	Oil Air Motor 1 oz. fluid	Plastic Container	
2	16	168-288-6	6	Rotor Blade(PC)	Phenolic-Fiber	
3	34	194-835-4	1	Filter	Sendered Plastic	

UX-900-RK

(Kit contains following parts)

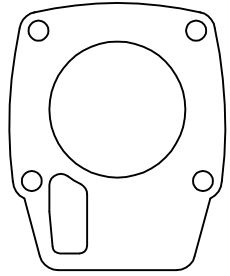
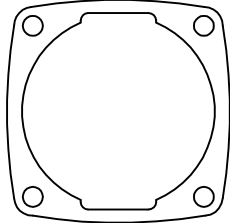
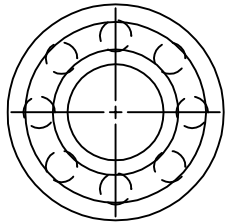
#/#	Item Number on Exploded View	Part Number	QTY	Description	Material	Drawing / Scketch
4	34	194-853-3	1	Rear Packing	Gasket Material	 <p style="text-align: center;">Scale 1:2</p>
5	32	194-867-3	1	Front Packing	Gasket Material	
6	60	982-403-0	1	Ball Bearing(EE-4)	Bearing Steel	
7	61	982-950-0	1	Ball Bearing(16002)	Bearing Steel	