

# UL-100MC SERIES OIL-PULSE WRENCHES

## EXPLODED VIEW

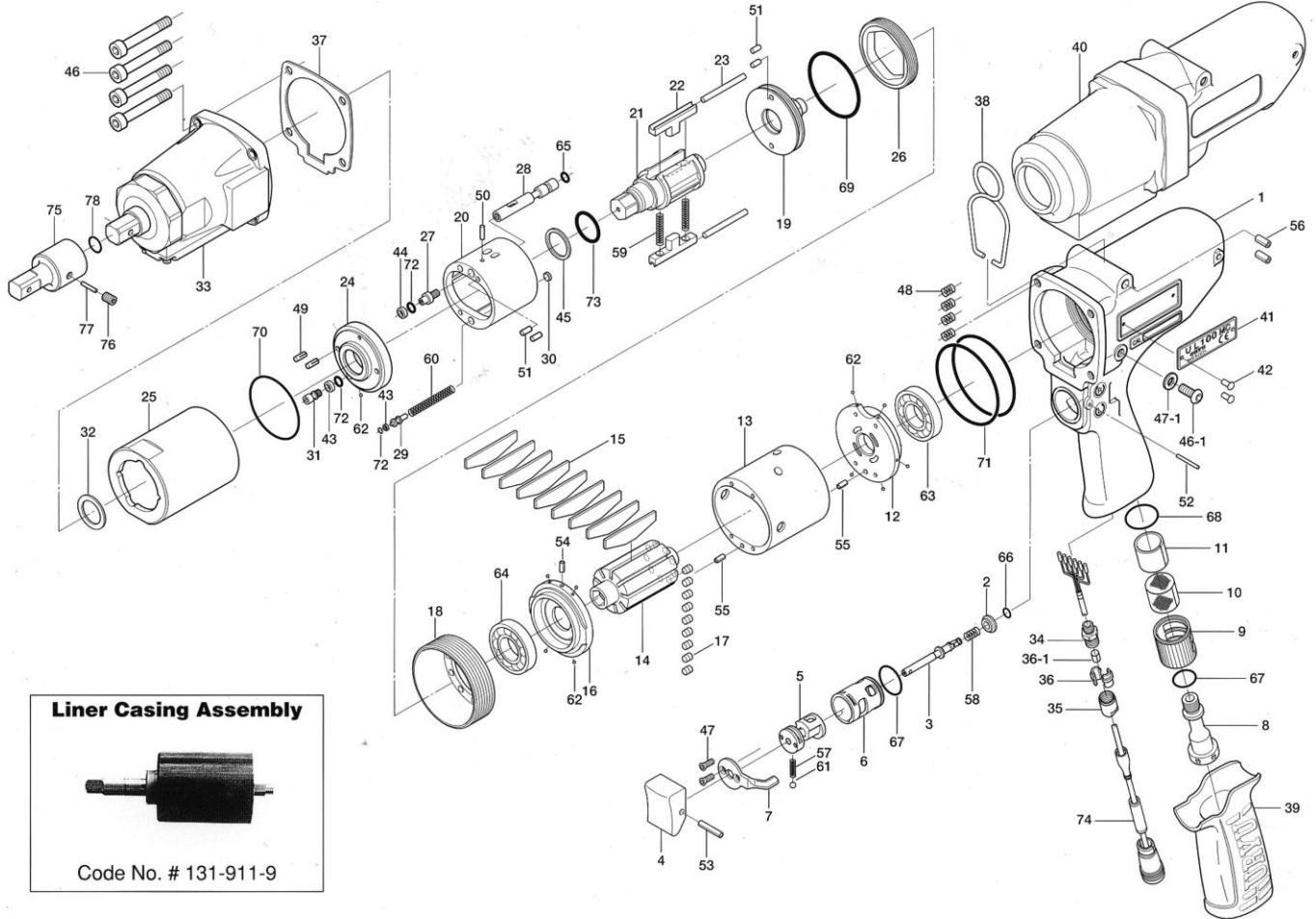

**Liner Casing Assembly**

Code No. # 131-911-9

## PARTS LIST — FOR REFERENCE ONLY

Index Number	Part Number	Description	Qty.	Index Number	Part Number	Description	Qty.	Index Number	Part Number	Description	Qty.
1	131-025-9	Handle	1	32	147-327-8	Anvil Front Spacer	1	56	973-308-0	Roll Pin (5X8)	2
2	147-100-8	Valve	1	33	851-692-1	Sensor Casing Assembly (S12S-UL)	1	57	976-006-0	Spring (3X5)	1
3	147-104-8	Valve Rod	1	34	851-301-1	Connector	1	58	976-643-0	Spring (7.5X9.7)(0.9)	1
4	147-107-2	Valve Lever	1	35	851-302-1	Cap	1	59	976-783-0	Spring 4.3X36(0.55)	2
5	147-210-8	Reverse Valve	1	36	851-303-1	Stopper	2	60	976-699-0	Spring 4.8X29.5(0.6)	1
6	147-211-8	Reverse Valve Bushing	1	36-1	131-395-8	Outer Ring	1	61	981-002-0	Ball (1/8)	1
7	147-212-8	Reverse Lever	1	37	131-867-9	Front Casing Packing	1	62	981-045-0	Ball (1.5)	10
8	148-091-3	Air Inlet Bushing	1	38	174-790-0	Suspension Ring	1	63	982-949-0	Ball Bearing (16001)	1
9	147-780-9	Exhaust Stack	1	39	131-842-6	Handle Cover	1	64	982-950-0	Ball Bearing (16002)	1
10	147-042-8	Silencer	1	40	131-840-9	Body Jacket	1	65	990-320-0	O-Ring (ARP568-003)	1
11	148-835-2	Filter (K50)	1	41	131-924-9	Metal Tag	1	66	990-306-0	O-Ring (ARP-568-004)(H)	1
12	148-285-2	Rear Plate	1	42	930-205-0	Driver Rivet No. 0X2.6	2	67	990-914-0	O-Ring (SNS-16)	2
13	851-391-1	Cylinder	1	43	944-003-0	Supporting Ring (3.0X5.0X1)	2	68	990-919-0	O-Ring (SNS-22)	1
14	148-287-2	Rotor	1	44	944-203-0	Back-up Ring (3.1X5X1)	1	69	990-929-0	O-Ring (SNS-36)	1
15	148-288-2	Blade (PC)	9	45	944-215-0	Supporting Ring (16X19.9X1.5)	1	70	990-928-0	O-Ring (SNS-38)	1
16	148-289-2	Front Plate	1	46	945-117-0	Allen Head Bolt (M5X16)	4	71	990-938-0	O-Ring (SNS-48)	2
17	148-064-2	Plug	9	46-1	945-949-0	Hexagon Round Head Bolt (M5X6)	1	72	990-970-0	O-Ring (SNS-2)	3
18	148-036-2	Hammer Casing Connector	1	47	948-423-0	Allen Flush Head Screw (M3X6)	2	73	992-021-0	Slit-Ring (Q16)(NTN)	1
19	851-312-1	Rear Liner Plate	1	47-1	961-012-0	Flat Washer (5mm)	1	74	910-258-0	Joint Cable Assembly	1
20	148-902-2	Liner	1	48	965-011-0	Held-sell (M5X.5D)	4	75	904-190-0	Extension Bar (1/2X60) (MC)	1
21	851-313-1	Anvil	1	49	969-450-0	Pin (G) (3X8)	2	76	953-205-0	Allen Head Flat Point Screw(M5X5)	1
22	148-440-2	Driving Blade	2	50	970-091-0	Pin (H) (2X4.5)	1	77	971-220-0	Pin (3X20)	1
23	148-974-2	Roller Pin (3X35)	2	51	970-205-0	Pin (H) (3X7)	4	78	990-016-0	O-Ring (P16)	1
24	148-904-2	Front Liner Plate	1	52	971-125-0	Pin (2X25)	1				
25	148-905-2	Liner Casing	1	53	973-014-0	Roll Pin (2X14)	1				
26	148-906-2	Liner Casing Cover	1	54	973-006-0	Roll Pin (2X6)	1				
27	174-907-2	Relief Valve Spindle	1	55	973-068-0	Roll Pin (2.5X8)	2				
28	148-970-2	Relief Valve	1								
29	147-972-8	Accumulator	1								
30	148-908-2	Accumulator Cover	1								
31	194-742-3	Oil Plug	1								

### ACCESSORIES

81	910-263-0	Sensor Casing Assembly (3F5)	1
82	909-749-0	Solenoid Valve Assembly	1

### OPTIONAL ACCESSORIES

91	910-633-0	Connector Cover	1
----	-----------	-----------------	---

### FOOTNOTES

- Items in Pulse Repair Kit UL-100-PRK
- ▲ Items in Repair Kit UL-100-RK

AIMCO also offers a complete line of standard & special adapters, bits, sockets and extensions.



10000 SE Pine Street  
Portland, OR 97216  
503-254-6600  
FAX 503-255-2615

When ordering spare parts, please specify tool type, part number and description.



# UL-100MC-PRK

(Kit contains following parts)

#/#	Item Number on Exploded View	Part Number	QTY	Description	Material	Drawing / Scketch
1	43	944-003-0	2	Support Ring	Teflon-White	
2	44	944-203-0	1	Back Up Ring	Teflon-White	
3	45	944-215-0	1	Support Ring	Teflon-White	
4	60	976-699-0	1	Spring	Spring wire	
5	59	976-783-0	2	Spring	Spring wire	
6	65	990-320-0	1	O-Ring	Buna-Black	
7	70	990-928-0	1	O-Ring	Buna-Black	

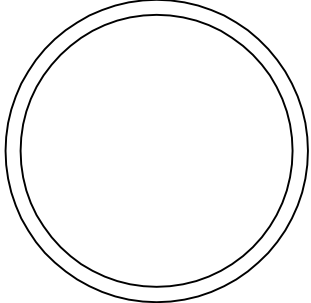

# UL-100MC-PRK

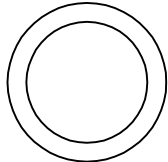
(Kit contains following parts)

#/#	Item Number on Exploded View	Part Number	QTY	Description	Material	Drawing / Scketch
8	69	990-929-0	1	O-Ring	Buna-Black	
9	72	990-970-0	3	O-Ring	Buna-Black	
10	73	992-021-0	1	SU-Ring	Buna-Black	

# UL-100MC-RK

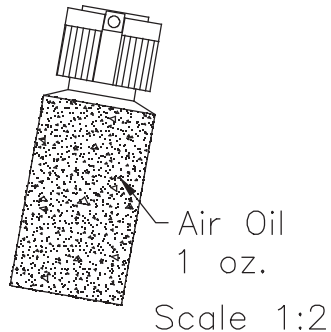
(Kit contains following parts)

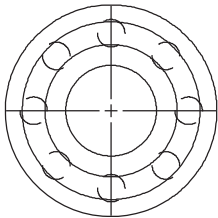
#/#	Item Number on Exploded View	Part Number	QTY	Description	Material	Drawing / Scketch
1	-	AM-OIL	1	Oil Air Motor 1 oz. fluid	Plastic Container	
2	<b>11</b>	148-835-2	1	Filter K50	Sendered Plastic	
3	<b>15</b>	148-288-2	9	Blade(PC)	Phenolic-Fiber	
4	<b>46-1</b>	982-949-0	1	Ball Bearing(16001)	Bearing Steel	

# UL-100MC-RK

(Kit contains following parts)

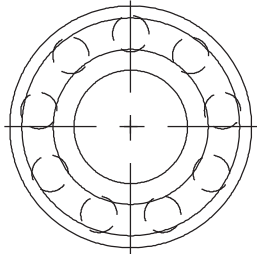
#/#	Item Number on Exploded View	Part Number	QTY	Description	Material	Drawing / Scketch
5	<b>64</b>	982-950-0	1	Ball Bearing(16002)	Bearing Steel	
6	<b>71</b>	990-938-0	2	O-Ring (SNS-48)	Buna-Black	