

# RH-90 ONE SHOT HAMMER

## EXPLODED VIEW

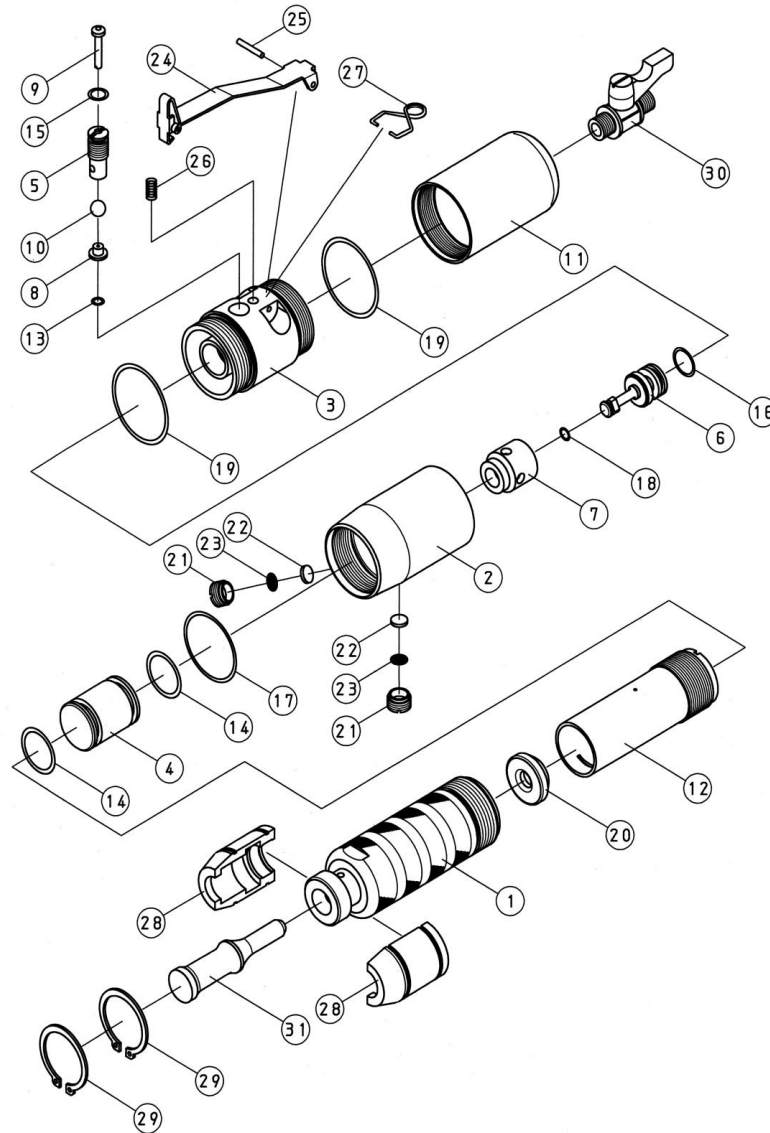

## PARTS LIST — FOR REFERENCE ONLY

Index Number	Part Number	Description	Qty.	Index Number	Part Number	Description	Qty.	Index Number	Part Number	Description	Qty.
1	RH-90-1	Head Cylinder	1	12	RH-90-12	Inner Cylinder	1	23	RH-90-23	Silencer Net	2
2	RH-90-2	Unit Cylinder	1	13	RH-90-13	O-Ring	1	24	RH-90-24	Switch Lever	1
3	RH-90-3	Switch Body	1	14	RH-90-14	O-Ring	2	25	RH-90-25	Spring Pin	1
4	RH-90-4	Hitting Piston	1	15	RH-90-15	O-Ring	1	26	RH-90-26	Lever Spring	1
5	RH-90-5	Set Screw	1	16	RH-90-16	O-Ring	1	27	RH-90-27	N-Hook	1
6	RH-90-6	Valve Piston	1	17	RH-90-17	O-Ring	1	28	RH-90-28	Rivet Snap Retainer	2
7	RH-90-7	Valve No. 1	1	18	RH-90-18	O-Ring	1	29	RH-90-29	Snap Retaining Ring	2
8	RH-90-8	Valve No. 2	1	19	RH-90-19	O-Ring	2	30	RH-90-30	Nipple with Stop Valve	1
9	RH-90-9	Air Pin	1	20	RH-90-20	Cushion Rubber	1	31	RH-90-31	Rivet Snap	1
10	RH-90-10	Urethane Ball	1	21	RH-90-21	Silencer Cap	2				
11	RH-90-11	Cap	1	22	RH-90-22	Silencer	2				

## FOOTNOTES



10000 SE PINE  
PORTLAND, OR 97216  
503-254-6600  
FAX 503-255-2615

When ordering spare parts, please specify  
tool type, part number, and description.