

UX-1300S OIL-PULSE TOOLS

EXPLODED VIEW

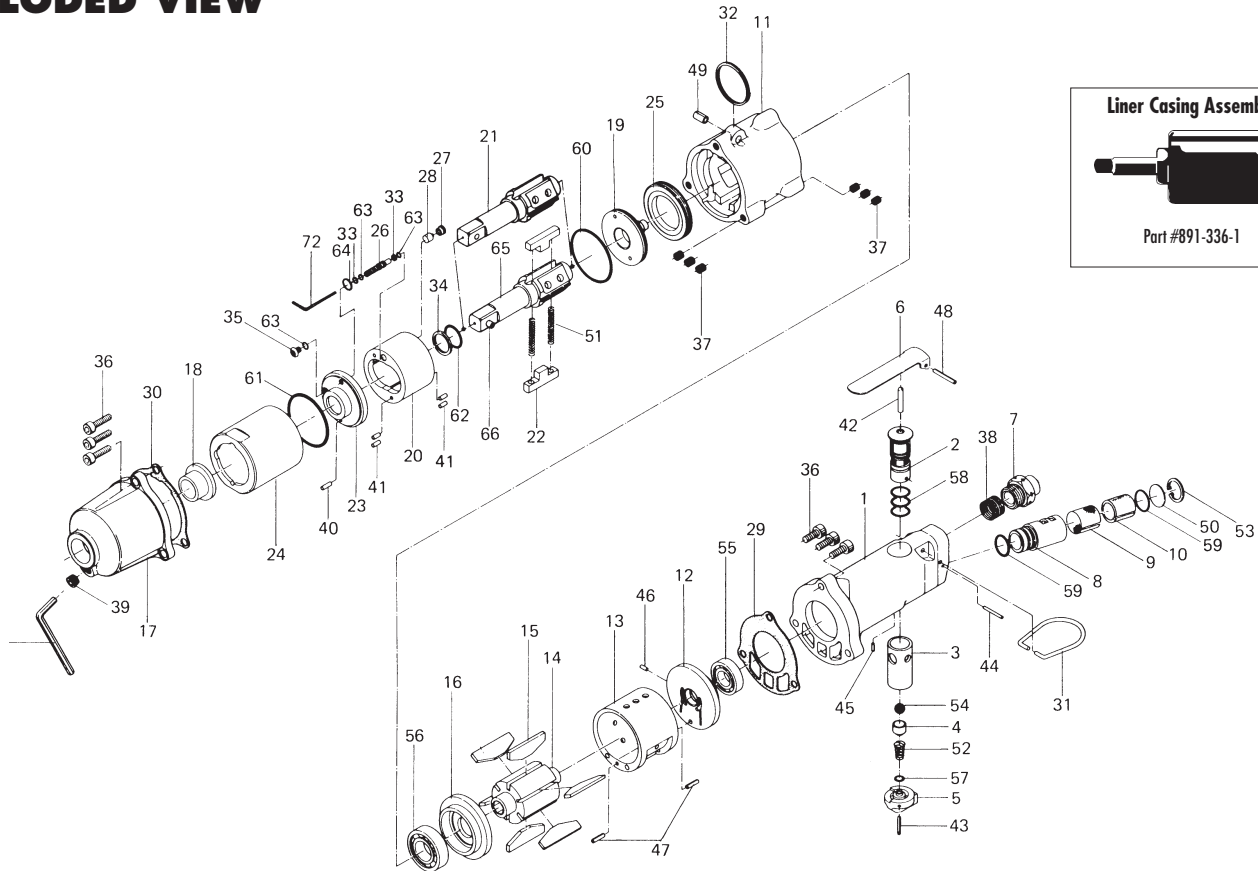

PARTS LIST — FOR REFERENCE ONLY

Index Number	Part Number	Description	Qty.	Index Number	Part Number	Description	Qty.	Index Number	Part Number	Description	Qty.
1	180-011-9	Handle	1	26	195-907-3	Relief Valve Spindle	1	49	973-340-0	Roll Pin (6 x 10)	1
2	180-210-7	Reverse Valve	1	27	195-969-3	Relief Valve Cover	1	50	975-598-0	Round Plate (18 x 1)	1
3	180-211-7	Reverse Valve Bushing	1	28	195-970-3	Relief Valve	1	51	976-453-0	Spring (4.5 x 34.5 x 6)	2 ●
4	188-100-1	Valve	1	29	180-851-9	Handle Packing	1	52	977-103-0	Cone Spring (6 x 9.5 x 16)	1
5	180-212-7	Reverse Lever	1	30	180-867-9	Front Casing Packing	1	53	979-318-0	Inner Snap Ring (IRTW18)	1
6	500-107-0	Valve Lever	1	31	004-790-2	Suspension Ring	1	54	981-208-0	Ball (5/16) Black	1
7	180-091-6	Air Inlet Bushing	1	32	010-790-1	Suspension Ring	1	55	982-404-0	Ball Bearing (EE-5)	1
8	194-780-4	Exhaust Stack	1	33	944-003-0	Supporter Ring (3 x 5 x 1)	2 ●	56	982-905-0	Ball Bearing (6904)	1
9	194-042-4	Silencer	1	34	944-210-0	Supporter Ring (16 x 19.9 x 1)	1 ●	57	990-005-0	O-Ring (P7)	1
10	194-835-6	Filter	1	35	945-942-0	Hexagon Round Head Bolt (M4 x 6)	1	58	990-909-0	O-Ring (SNS-11.2)	3
11	180-025-9	Casing	1	36	945-218-0	Allen Head Bolt (M6 x 18)	6	59	990-914-0	O-Ring (SNS-16)	2
12	194-285-6	Rear Plate	1	37	965-021-0	Heli-Sert (M6 x 1.5D)	6	60	990-930-0	O-Ring (SNS-40)	1 ●
13	063-286-7	Cylinder	1	38	965-073-0	Heli-Sert (UNF5/8 x N6)	1	61	990-932-0	O-Ring (SNS-42)	1 ●
14	194-287-6	Rotor	1	39	966-100-0	Allen Head Plug (1/8)	1	62	992-021-0	O-Ring (Q-16 NTN)	1 ●
15	194-288-6	Blade	6	40	969-450-0	Pin (G) (3 x 8)	1	63	990-971-0	O-Ring (SNS-3 NOK)	3 ●
16	194-289-6	Front Plate	1	41	970-206-0	Pin (H) (3 x 8)	4	64	990-974-0	O-Ring (SNS-6 NOK)	1 ●
17	180-439-9	Front Casing	1	42	970-326-0	Pin (H) (4 x 25)	1	65	891-313-1	Anvil (OP-P)	1
18	189-328-8	Anvil Bushing	1	43	971-122-0	Pin (2 x 22)	1	66	891-304-1	Socket Retainer Pin Assembly	1
19	194-901-6	Rear Liner Plate	1	44	971-163-0	Pin (2.5 x 23)	1				
20	194-902-6	Liner	1	45	973-006-0	Roll Pin (2 x 6)	1	ACCESSORIES			
21	194-319-7	Anvil (OP-P)	1	46	973-066-0	Roll Pin (2.5 x 6)	1	71	939-104-0	Allen Wrench (5 mm)	1
22	194-440-7	Driving Blade	2	47	973-212-0	Roll Pin (4 x 12)	2	72	939-109-0	Allen Wrench (2 mm)	1
23	194-904-4	Front Liner Plate	1	48	973-124-0	Roll Pin (3 x 24)	1				
24	194-905-6	Liner Casing	1								
25	194-906-4	Liner Casing Cover	1								

FOOTNOTES

● = Items in Pulse Repair Kit UX-1300S-PRK



10000 SE PINE
PORTLAND, OR 97216
503-254-6600
FAX 503-255-2615

When ordering spare parts, please specify tool type, part number, and description.

UX-1300S-PRK

(Kit contains following parts)

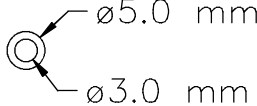
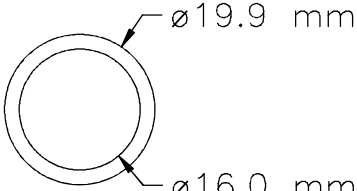
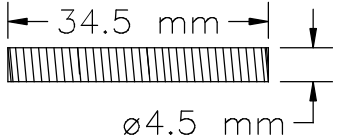
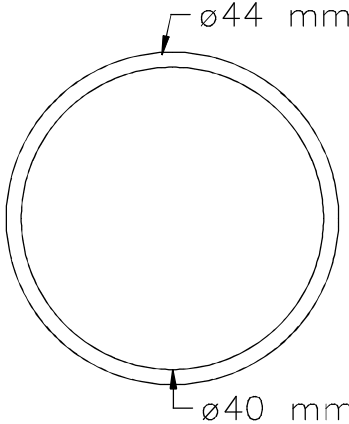
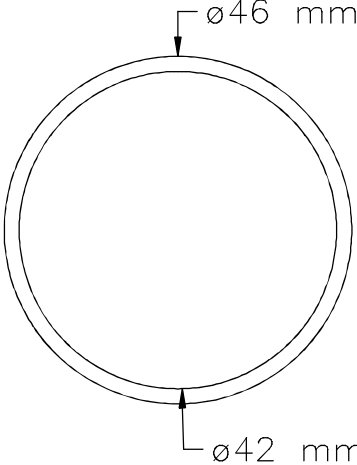
#/#	Bin Location	Part Number	QTY	Description	Material	Drawing / Scketch
1	PA10	944-003-0	2	Support Ring 3.0x5.0x1	Teflon-White	
2	PA10	944-210-0	1	Support Ring 16x19.9x1	Teflon-White	
3	PA11	976-453-0	1	Spring 4.5x34.5 (0.6)WPC	Spring wire ø.60 mm	
4	PA1B	990-930-0	1	O-Ring (SNS-40) 40x44x2	Buna-Black	
5	PA1B	990-932-0	1	O-Ring (SNS-42) 42x46x2	Buna-Black	

UX-1300S-PRK

(Kit contains following parts)

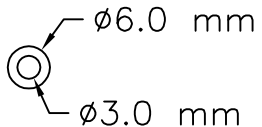
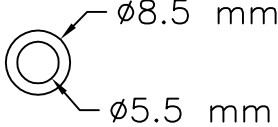
#/#	Bin Location	Part Number	QTY	Description	Material	Drawing / Scketch
6	PA1C	990-971-0	3	O-Ring (SNS-3) (NOK)	Buna-Black	
7	PA1C	990-974-0	1	O-Ring (SNS-6) (NOK)	Buna-Black	
8	PA10	992-021-0	1	SU-Ring (Q-19) (NTN) 16x21x2.5	Buna-Black	