

UXR-2000 OIL-PULSE TOOLS

EXPLODED VIEW

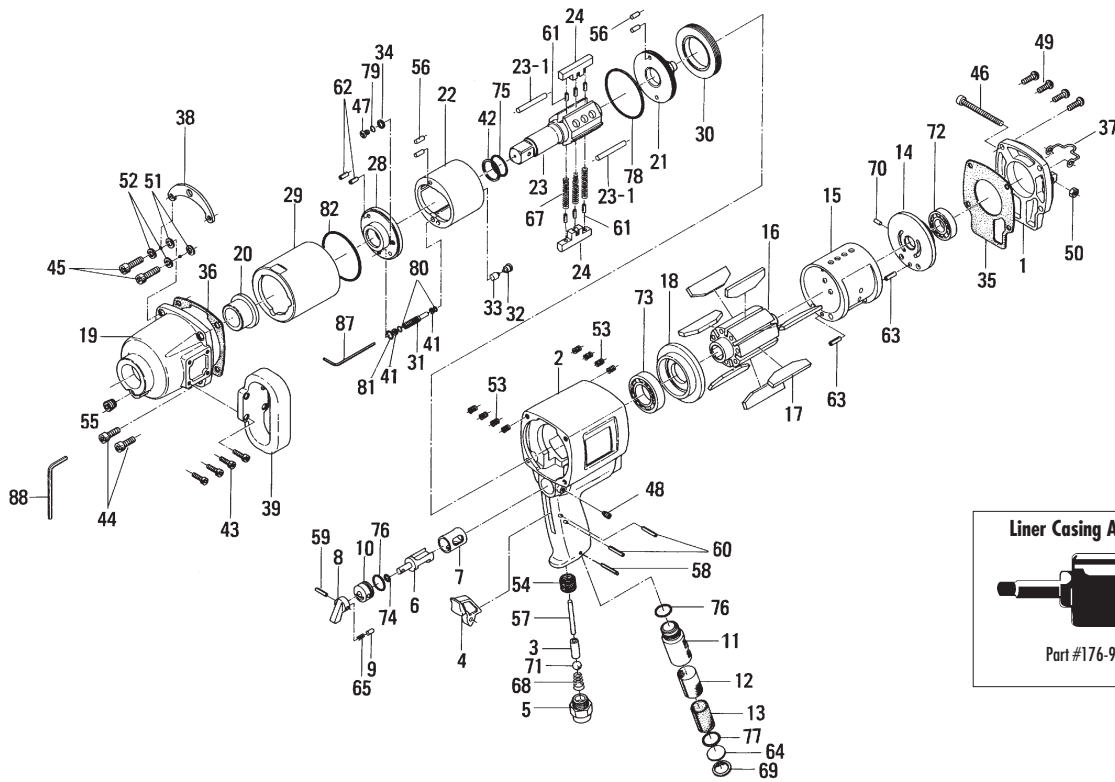

PARTS LIST — FOR REFERENCE ONLY

| Index Number | Part Number | Description | Qty. | Index Number | Part Number | Description | Qty. | Index Number | Part Number | Description | Qty. |
|--------------|-------------|-----------------------|------------|--------------|-------------|--------------------------------------|------|--------------|-------------|--------------------------------|------|
| 1 | 194-012-1 | Head Cover | 1 | 32 | 194-969-9 | Relief Valve Plug | 1 | 60 | 973-118-0 | Roll Pin (3 x 18) | 2 |
| 2 | 194-025-1 | Handle | 1 | 33 | 194-970-8 | Relief Valve | 1 | 61 | 973-208-0 | Roll Pin (4 x 8) | 6 |
| 3 | 087-103-1 | Valve Rod Bushing | 1 | 34 | 188-807-1 | Spacer | 1 | 62 | 969-408-0 | Pin (G) (5 x 10) | 2 |
| 4 | 026-107-7 | Throttle Trigger | 1 | 35 | 194-853-8 | Rear Packing | 1 | 63 | 973-316-0 | Roll Pin (5 x 16) | 2 |
| 5 | 194-091-8 | Air Inlet Bushing | 1 | 36 | 194-867-8 | Front Packing | 1 | 64 | 975-603-0 | Round Plate (24 x 1) | 1 |
| 6 | 194-210-8 | Reverse Valve | 1 | 37 | 194-790-8 | Suspension Bail | 1 | 65 | 976-025-0 | Spring (3 x 8.5) | 1 |
| 7 | 194-211-8 | Reverse Valve Bushing | 1 | 38 | 194-794-8 | Suspension Plate | 1 | 67 | 976-797-0 | Spring (6.35 x 45.5) (0.8) WPC | 3 ● |
| 8 | 023-212-4 | Reverse Lever | 1 | 39 | 090-721-1 | Dead Handle | 1 | 68 | 977-256-0 | Cone Spring (10 x 15 x 22) | 1 |
| 9 | 054-220-1 | Reverse Lever Notch | 1 | 41 | 944-005-0 | Supporting Ring (4.2 x 6 x 1) | 2 ● | 69 | 979-017-0 | Inner Snap Ring (24) | 1 |
| 10 | 194-222-8 | Reverse Lever Setter | 1 | 42 | 944-225-0 | Supporting Ring (25.2 x 29.4 x 1.5) | 1 ● | 70 | 980-009-0 | Round Head Notch (4) | 1 |
| 11 | 194-780-8 | Exhaust Stack | 1 | 43 | 945-112-0 | Allen Head Bolt (M5 x 12) | 4 | 71 | 981-032-0 | Ball (7/16) | 1 |
| 12 | 194-042-8 | Silencer Ø0.2 x 30 | 1 | 44 | 945-220-0 | Allen Head Bolt (M6 x 20) | 2 | 72 | 982-203-0 | Ball Bearing (6203) | 1 |
| | 176-042-0 | Silencer Ø0.21 x 60 | >either/or | 45 | 945-225-0 | Allen Head Bolt (M6 x 25) | 2 | 73 | 982-960-0 | Ball Bearing (60/28) | 1 |
| 13 | 176-835-0 | Filter (K50) | 1 | 46 | 945-265-0 | Allen Head Bolt (M6 x 65) | 1 | 74 | 990-205-0 | O-Ring (JW1516-5) | 1 |
| 14 | 194-285-9 | Rear Plate | 1 | 47 | 945-960-0 | Hexagon Round Head Bolt (M6 x 8) | 1 | 75 | 990-170-0 | O-Ring (ARP568-120) (NTN) | 1 ● |
| 15 | 194-286-8 | Cylinder | 1 | 48 | 952-210-0 | Allen Head Dog Point Screw (M5 x 10) | 1 | 76 | 990-918-0 | O-Ring (SNS-20) | 2 |
| 16 | 194-287-8 | Rotor | 1 | 49 | 945-965-0 | Hex Round Head Bolt (M6 x 20) | 4 | 77 | 990-919-0 | O-Ring (SNS-22) | 1 |
| 17 | 194-288-8 | Blade | 7 | 50 | 960-804-0 | U-Nut (M6) | 1 | 78 | 990-943-0 | O-Ring (SNS-63) | 1 ● |
| 18 | 194-289-8 | Front Plate | 1 | 51 | 961-013-0 | Flat Washer (6mm) | 2 | 79 | 990-949-0 | O-Ring (P-3) (NOK) | 1 ● |
| 19 | 194-439-8 | Front Casing | 1 | 52 | 962-078-0 | Spring Washer (6.3 x 9.5 x 1.5) | 8 | 80 | 990-972-0 | O-Ring (SNS-4) (NOK) | 2 ● |
| 20 | 194-328-8 | Anvil Bushing | 1 | 53 | 965-021-0 | Heli-Sert (M6 x 1.5D) | 8 | 81 | 990-975-0 | O-Ring (SNS-8) (NOK) | 1 ● |
| 21 | 194-901-8 | Rear Liner Plate | 1 | 54 | 965-120-0 | Heli-Sert (M20 x 1D) | 1 | 82 | 990-990-0 | O-Ring (SNS-65) | 1 ● |
| 22 | 194-902-8 | Liner | 1 | 55 | 966-101-0 | Allen Head Plug (1/4) | 1 | | | | |
| 23 | 18H-319-3 | Anvil | 1 | 56 | 970-408-0 | Pin (H) (5 x 8) | 4 | | | | |
| 23-1 | 176-974-5 | Roller (4.4 x 55) | 2 | 57 | 970-452-0 | Pin (H) (5 x 51.5) | 1 | | | | |
| 24 | 194-440-9 | Driving Blade | 2 | 58 | 971-166-0 | Pin (2.5 x 26) | 1 | | | | |
| 28 | 176-904-0 | Front Liner Plate | 1 | 59 | 973-016-0 | Roll Pin (2 x 16) | 1 | | | | |
| 29 | 194-905-8 | Liner Casing | 1 | | | | | | | | |
| 30 | 194-906-8 | Liner Casing Setter | 1 | | | | | | | | |
| 31 | 194-907-8 | Relief Valve Spindle | 1 | | | | | | | | |

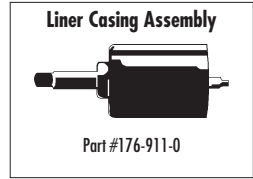

ACCESSORIES

| | | | |
|------|-----------|--------------------------------|---|
| 78-1 | 944-067-0 | Supporter Ring (67 x 70 x 1) | 1 |
| 87 | 939-111-0 | Allen Wrench (6 mm) (125 x 60) | 1 |
| 88 | 939-007-0 | Allen Wrench (6 mm) | 1 |

FOOTNOTES

● = Items in Pulse Repair Kit UXR-2000-PRK



10000 SE PINE
PORTLAND, OR 97216
503-254-6600
FAX 503-255-2615

When ordering spare parts, please specify tool type, part number, and description.

UXR-2000-PRK

(Kit contains following parts)

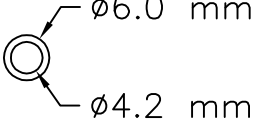
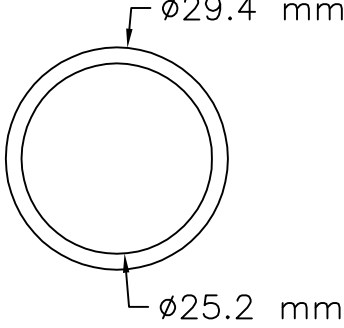
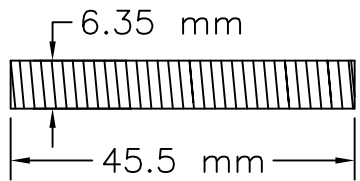
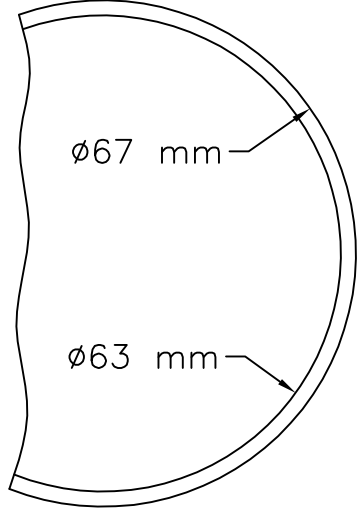
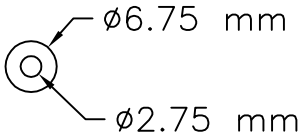
| #/# | Bin Location | Part Number | QTY | Description | Material | Drawing / Scketch |
|-----|--------------|-------------|-----|----------------------------------|-----------------------|---|
| 1 | PA10 | 944-005-0 | 2 | Support Ring 4.2x6x1 | Teflon-White |  |
| 2 | PA10 | 944-225-0 | 1 | Supporting Ring 25.2x29.4x1.5 | Teflon-White |  |
| 3 | PA1J | 976-797-0 | 3 | Spring 6.35x45.5 | Spring wire ø.8 mm |  |
| 4 | PA1B | 990-943-0 | 1 | O-Ring (SNS-63) 63x67x2 | Buna-Black |  |
| 5 | PA1C | 990-949-0 | 1 | O-Ring (P3) (NOK) | Buna-Black |  |

UXR-2000-PRK

(Kit contains following parts)

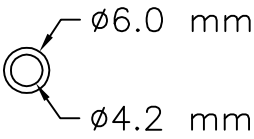
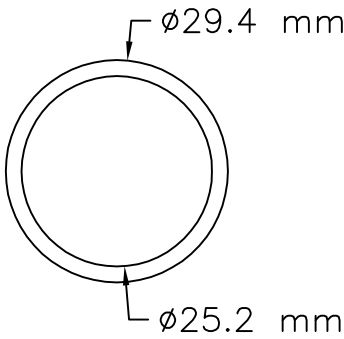
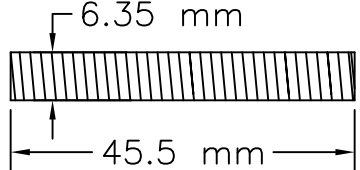
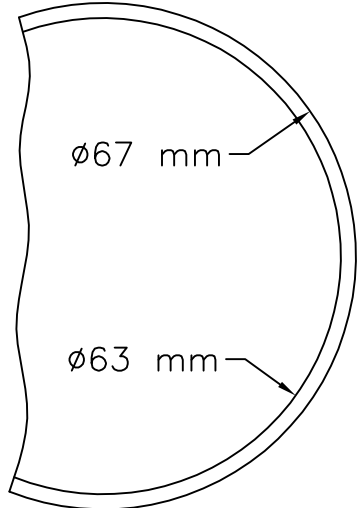
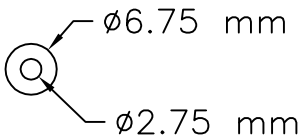
| #/# | Bin Location | Part Number | QTY | Description | Material | Drawing / Scketch |
|-----|--------------|-------------|-----|----------------------------------|-----------------------|---|
| 1 | PA10 | 944-005-0 | 2 | Support Ring 4.2x6x1 | Teflon-White |  |
| 2 | PA10 | 944-225-0 | 1 | Supporting Ring 25.2x29.4x1.5 | Teflon-White |  |
| 3 | PA1J | 976-797-0 | 3 | Spring 6.35x45.5 | Spring wire ø.8 mm |  |
| 4 | PA1B | 990-943-0 | 1 | O-Ring (SNS-63) 63x67x2 | Buna-Black |  |
| 5 | PA1C | 990-949-0 | 1 | O-Ring (P3) (NOK) | Buna-Black |  |

UXR-2000-PRK

(Kit contains following parts)

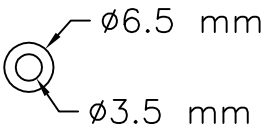
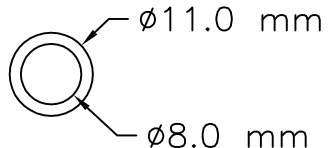
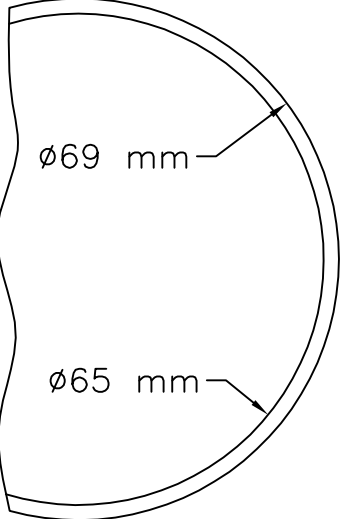
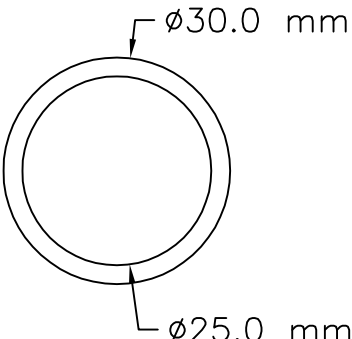
| #/# | Bin Location | Part Number | QTY | Description | Material | Drawing / Scketch |
|-----|--------------|-------------|-----|-------------------------------------|--------------|---|
| 6 | PA1C | 990-972-0 | 2 | O-Ring (SNS-4) (NOK) | Buna-Black |  |
| 7 | PA1C | 990-975-0 | 1 | O-Ring (SNS-8) (NOK) 8x11x1.5 | Buna-Black |  |
| 8 | PA1C | 990-990-0 | 1 | O-Ring (SNS-65) 65x69x2 | Buna-Black |  |
| 9 | PA10 | 995-500-0 | 1 | Teflon Seal (120) 25x30x3.2 | Teflon-Black |  |